



City of Chicago



O2019-1383

Office of the City Clerk

Document Tracking Sheet

Meeting Date:	3/13/2019
Sponsor(s):	Misc. Transmittal
Type:	Ordinance
Title:	Zoning Reclassification Map No. 1-G at 1000 W Carroll Ave, 311 N Morgan and 345 N Morgan St - App No. 19980
Committee(s) Assignment:	Committee on Zoning, Landmarks and Building Standards

#19980
INTRO DATE
MARCH 13, 2019

ORDINANCE

BE IT ORDAINED BY THE CITY COUNCIL OF THE CITY OF CHICAGO:

SECTION 1. That the Chicago Zoning Ordinance be amended by changing all of the M2-3 Light Industry District symbols and indications as shown on Map 1-G in the area bounded by:

North Carroll Avenue; North Carpenter Street; the south line of Metra (formerly known as the Chicago, Milwaukee, St. Paul & Pacific Railroad); a line 138.46 feet east of and parallel to North Morgan Street; a line 229.07 feet north of and parallel to the alley north of and parallel to West Fulton Market; a line 125 feet east of and parallel to North Morgan Street; the alley north of and parallel to West Fulton Market and North Morgan Street.

to those of a DX-5 Downtown Mixed-Use District.

SECTION 2. That the Chicago Zoning Ordinance be amended by changing all of the DX-5 Downtown Mixed-Use District symbols and indications as shown on Map 1-G in the area bounded by:

North Carroll Avenue; North Carpenter Street; the south line of Metra (formerly known as the Chicago, Milwaukee, St. Paul & Pacific Railroad); a line 138.46 feet east of and parallel to North Morgan Street; a line 229.07 feet north of and parallel to the alley north of and parallel to West Fulton Market; a line 125 feet east of and parallel to North Morgan Street; the alley north of and parallel to West Fulton Market and North Morgan Street.

to those of a Business Planned Development which is hereby established in the area above described, subject to such use and bulk regulations as are set forth in the Plan of Development herewith attached and made a part thereof and to no others.

SECTION 3. This Ordinance shall be in force and effect from and after its passage and due publication.

Address: 1000 West Carroll / 311 and 345 North Morgan, Chicago, IL

EAST165037819.3

BUSINESS PLANNED DEVELOPMENT NO. _____
PLANNED DEVELOPMENT STATEMENTS

1. The area delineated herein as Planned Development Number _____, (“Planned Development”) consists of approximately 105,924 square feet of property which is depicted on the attached Planned Development Boundary and Property Line Map (the “Property”). 345 N. Morgan, LLC is the owner of a portion of the Property and the “Applicant” for this Planned Development pursuant to authorization from the owners of the remainder of the Property.
2. The requirements, obligations and conditions contained within this Planned Development shall be binding upon the Applicant, its successors and assigns and, if different than the Applicant, the legal title holders and any ground lessors. All rights granted hereunder to the Applicant shall inure to the benefit of the Applicant’s successors and assigns and, if different than the Applicant, the legal title holder and any ground lessors. Furthermore, pursuant to the requirements of Section 17-8-0400 of the Chicago Zoning Ordinance (the “Zoning Ordinance”), the Property, at the time of application for amendments, modifications or changes (administrative, legislative or otherwise) to this Planned Development, shall be under single ownership or designated control. Single designated control is defined in Section 17-8-0400 of the Zoning Ordinance.
3. All applicable official reviews, approvals or permits are required to be obtained by the Applicant or its successors, assignees or grantees. Any dedication or vacation of streets or alleys or grants of easements or any adjustment of the right-of-way shall require a separate submittal to the Chicago Department of Transportation (“CDOT”) on behalf of the Applicant or its successors, assigns or grantees.

Any requests for grants of privilege, or any items encroaching on the public way, shall be in compliance with the Plans (defined below).

Ingress or egress shall be pursuant to the Plans and may be subject to the review and approval of the Department of Planning and Development (“DPD”) and CDOT. Closure of all or any public street or alley during demolition or construction shall be subject to the review and approval of CDOT.

All work proposed in the public way must be designed and constructed in accordance with CDOT Standards for Work in the Public Way and in compliance with the Municipal Code of the City of Chicago. Prior to the issuance of any Part II approval, the submitted plans must be approved by CDOT.

Pursuant to a negotiated and executed Perimeter Restoration Agreement (“Agreement”) by and between the City’s Department of Transportation’s Division of Infrastructure Management and the Applicant, the Applicant shall provide improvements and restoration of all public way adjacent to the property, which may include, but not be limited to, the following as shall be reviewed and determined by CDOT’s Division of Infrastructure Management:

- Full width of streets
- Full width of alleys
- Curb and gutter
- Pavement markings
- Sidewalks

Applicant: 345 N. Morgan, LLC
Address: 1000 West Carroll / 311 and 345 North Morgan, Chicago, IL
Introduced: March 13, 2019
Plan Commission: TBD

.....

.....

- ADA crosswalk ramps
- Parkway & landscaping

The Perimeter Restoration Agreement must be must be executed prior to any CDOT and Planned Development Part II review permitting. The Agreement shall reflect that all work must comply with current Rules and Regulations and must be designed and constructed in accordance with the CDOT Construction Standards for work in the Public Way and in compliance with the Municipal Code of Chicago Chapter 10-20. Design of said improvements should follow the CDOT Rules and Regulations for Construction in the Public Way as well as The Street and Site Plan Design Guidelines. Any variation in scope or design of public way improvements and restoration must be approved by CDOT.

4. This Planned Development consists of these 17 Statements; a Bulk Regulations and Data Table and the following exhibits and plans attached hereto prepared by SOM and dated _____, 2019 (the "Plans"): an Existing Zoning Map; an Existing Land Use Map; a Planned Development and Property Line Map; a Subarea Map; a Subarea A Site/Landscape Plan; a Subarea A Roof Plan; Subarea A Building Elevations (North, South, East and West); a Subarea B Site/Landscape Plan; a Subarea B Roof Plan; Subarea B Building Elevations (North, South, East and West); a Subarea C Site/Landscape Plan; a Subarea C Roof Plan; and Subarea C Building Elevations (North, South, East and West). In any instance where a provision of this Planned Development conflicts with the Chicago Building Code, the Building Code shall control. This Planned Development conforms to the intent and purpose of the Zoning Ordinance, and all requirements thereof, and satisfies the established criteria for approval as a Planned Development. In case of a conflict between the terms of this Planned Development Ordinance and the Zoning Ordinance, this Planned Development Ordinance shall control.
5. The following uses are permitted in the area delineated herein as a Business Planned Development: Office; Hotel; Daycare; Animal Services; Business Equipment Sales and Service; Business Support Services; Urban Farm (rooftop operation); Communication Service Establishments; Eating and Drinking Establishments (all, including Taverns); Entertainment and Spectator Sports (excluding inter-track wagering facilities); Indoor Special Event including incidental liquor sales; Financial Services; Food and Beverage Retail Sales; Medical Service; Personal Service; General Retail Sales; Participant Sports and Recreation; Limited and Artisan Manufacturing, Production and Industrial Services; Co-located Wireless Communication Facilities, accessory parking, non-accessory parking and incidental and accessory uses.
6. On-Premise signs and temporary signs, such as construction and marketing signs, shall be permitted within the Planned Development, subject to the review and approval of DPD. Off-Premise signs are prohibited within the boundary of the Planned Development.
7. For purposes of height measurement, the definitions in the Zoning Ordinance shall apply. The height of any building shall also be subject to height limitations, if any, established by the Federal Aviation Administration.
8. The maximum permitted Floor Area Ratio ("FAR") for the Property shall be in accordance with the attached Bulk Regulations and Data Table. For the purposes of FAR calculations and measurements, the definitions in the Zoning Ordinance shall apply. The permitted overall FAR identified in the Bulk Regulations Table has been determined using a Net Site Area of 105,924 square feet.

Applicant: 345 N. Morgan, LLC
 Address: 1000 West Carroll / 311 and 345 North Morgan, Chicago, IL
 Introduced: March 13, 2019
 Plan Commission: TBD

The Applicant acknowledges that the project has received a bonus FAR of 3.1, pursuant to Sec. 17-4-1000 of the Zoning Ordinance. With this bonus FAR, the total FAR for the Planned Development is 8.1. In exchange for the bonus FAR, the Applicant is required to make a corresponding payment, pursuant to Sections 17.4-1003-B & C, prior to the issuance of the first building permit for any building in the Planned Development; provided, however, if the Planned Development is constructed in phases, the bonus payment may be paid on a pro rata basis as the first building permit for each subsequent new building or phase of construction is issued. The bonus payment will be recalculated at the time of payment (including partial payments for phased developments) and may be adjusted based on changes in median land values in accordance with Section 17-4-1003-C.3

The bonus payment will be split between three separate funds, as follows: 80% to the Neighborhoods Opportunity Fund, 10% to the Citywide Adopt-a-Landmark Fund and 10% to the Local Impact Fund. In lieu of paying the City directly, the Department may: (a) direct developers to deposit a portion of the funds with a sister agency to finance specific local improvement projects; (b) direct developers to deposit a portion of the funds with a landmark property owner to finance specific landmark restoration projects; or, (c) approve proposals for in-kind improvements to satisfy the Local Impact portion of the payment.

9. Upon review and determination, "Part II Review", pursuant to Section 17-13-0610 of the Zoning Ordinance, a Part II Review Fee shall be assessed by DPD. The fee, as determined by staff at the time, is final and binding on the Applicant and must be paid to the Department of Revenue prior to the issuance of any Part II approval.

The Plans are hereby approved in their entirety and no further approvals shall be required under this Planned Development or the Zoning Ordinance for the improvements undertaken in accordance with the Plans, other than Part II Approval (per Section 17-13-0610 of the Zoning Ordinance).

10. The Site and Landscape Plans shall be in substantial conformance with the Landscape Ordinance and any other corresponding regulations and guidelines. Final landscape plan review and approval will be by DPD. Any interim reviews associated with site plan review or Part II reviews, are conditional until final Part II approval.
11. The Applicant shall comply with Rules and Regulations for the Maintenance of Stockpiles promulgated by the Commissioners of the Departments of Streets and Sanitation, Fleet and Facility Management and Buildings, under Section 13-32-125 of the Municipal Code, or any other provision of that Code.
12. The terms and conditions of development under this Planned Development ordinance may be modified administratively, pursuant to section 17-13-0611-A of the Zoning Ordinance by the Zoning Administrator upon the application for such a modification by the Applicant, its successors and assigns and, if different than the Applicant, the legal title holders and any ground lessors.
13. The Applicant acknowledges that it is in the public interest to design, construct and maintain the project in a manner which promotes, enables and maximizes universal access throughout the Property. Plans for all buildings and improvements on the Property shall be reviewed and approved by the Mayor's Office for People with Disabilities to ensure compliance with all applicable laws and regulations related to access for persons with disabilities and to promote the highest standard of accessibility.

Applicant: 345 N. Morgan, LLC
Address: 1000 West Carroll / 311 and 345 North Morgan, Chicago, IL
Introduced: March 13, 2019
Plan Commission: TBD

14. The Applicant acknowledges that it is in the public interest to design, construct, renovate and maintain all buildings in a manner that provides healthier indoor environments, reduces operating costs and conserves energy and natural resources. The Applicant shall obtain the number of points necessary to meet the requirements of the Chicago Sustainable Development Policy, in effect at the time the Part II review process is initiated for each improvement that is subject to the aforementioned Policy and must provide documentation verifying compliance.
15. The Applicant acknowledges that it is the policy of the City to maximize opportunities for Minority and Women-owned Business Enterprises (“M/WBEs”) and city residents to compete for contracts and jobs on construction projects approved through the planned development process. To assist the city in promoting and tracking such M/WBE and city resident participation, an applicant for planned development approval shall provide information at three points in the city approval process. First, the applicant must submit to DPD, as part of its application for planned development approval, an M/WBE Participation Proposal. The M/WBE Participation Proposal must identify the applicant’s goals for participation of certified M/WBE firms in the design, engineering and construction of the project, and of city residents in the construction work. The city encourages goals of (i) 26% MBE and 6% WBE participation (measured against the total construction budget for the project or any phase thereof), and (ii) 50% city resident hiring (measured against the total construction work hours for the project or any phase thereof). The M/WBE Participation Proposal must include a description of the Applicant’s proposed outreach plan designed to inform M/WBEs and city residents of job and contracting opportunities. Second, at the time of the Applicant’s submission for Part II permit review for the project or any phase thereof, the Applicant must submit to DPD (a) updates (if any) to the Applicant’s preliminary outreach plan, (b) a description of the Applicant’s outreach efforts and evidence of such outreach, including, without limitation, copies of certified letters to M/WBE contractor associations and the ward office of the alderman in which the project is located and receipts thereof; (c) responses to the Applicant’s outreach efforts, and (d) updates (if any) to the applicant’s M/WBE and city resident participation goals. Third, prior to issuance of a Certificate of Occupancy for the project or any phase thereof, the Applicant must provide DPD with the actual level of M/WBE and city resident participation in the project or any phase thereof, and evidence of such participation. In addition to the forgoing, DPD may request such additional information as the department determines may be necessary or useful in evaluating the extent to which M/WBEs and city residents are informed of and utilized in planned development projects. All such information will be provided in a form acceptable to the Zoning Administrator. DPD will report the data it collects regarding projected and actual employment of M/WBEs and city residents in planned development projects twice yearly to the Chicago Plan Commission and annually to the Chicago City Council and the Mayor.
16. The Applicant acknowledges that the Property is located in the Kinzie Industrial Corridor Conversion Area, and has undergone a “rezoning” within the meaning of Chapter 16-8 of the Municipal Code (the “Industrial Corridor System Fund Ordinance”). As a result of this rezoning, the Planned Development is subject to the conversion fee provisions of the Industrial Corridor System Fund Ordinance. The purpose of the conversion fee is to mitigate the loss of industrial land and facilities in conversion areas by generating funds for investment in receiving industrial corridors in order to preserve and enhance the city’s industrial base, support new and expanding industrial uses, and ensure a stable future for manufacturing and industrial employment in Chicago. The Applicant is required to pay the conversion fee in full prior to the issuance of the first building permit for any building in the Planned Development; provided, however, if the Planned Development is constructed in phases, the conversion fee may be paid on a pro rata basis as the first building permit for each subsequent new building or phase of construction

Applicant: 345 N. Morgan, LLC
Address: 1000 West Carroll / 311 and 345 North Morgan, Chicago, IL
Introduced: March 13, 2019
Plan Commission: TBD

is issued. The amount of the conversion fee due prior to the issuance of a building permit shall be calculated based on the fee rate in effect at the time of payment. The Applicant shall record a notice against the Property to ensure that the requirements of the Industrial Corridor System Fund Ordinance are enforced in accordance with Sec. 16-8-100.

17. This Planned Development shall be governed by Section 17-13-0612 of the Zoning Ordinance. Should this Planned Development ordinance lapse, the Commissioner of DPD shall initiate a Zoning Map Amendment to rezone the property to the DX-5 Downtown Mixed-Use District.

Applicant: 345 N. Morgan, LLC
Address: 1000 West Carroll / 311 and 345 North Morgan, Chicago, IL
Introduced: March 13, 2019
Plan Commission: TBD

BUSINESS PLANNED DEVELOPMENT NO. _____
BULK REGULATIONS AND DATA TABLE

Gross Site Area (sf): 143,292

Subarea A: 68,740

Subarea B: 32,509

Subarea C: 42,043

Area of Public Rights-of-Way (sf): 37,369

Subarea A: 22,437

Subarea B: 6,292

Subarea C: 8,640

Net Site Area (sf): 105,924

Subarea A: 46,303

Subarea B: 26,217

Subarea C: 33,403

Maximum Floor Area Ratio: 8.10 (857,976 SF)

Subarea A: 11.58 (536,251 SF)

Subarea B: 8.10 (212,358 SF)

Subarea C: 3.27 (109,367 SF)

Maximum Accessory Off-Street Parking Spaces:

Subarea A: 144

Subarea B: 37

Subarea C: 30

Minimum Off-Street Loading Spaces:

Applicant: 345 N. Morgan, LLC
Address: 1000 West Carroll / 311 and 345 North Morgan, Chicago, IL
Introduced: March 13, 2019
Plan Commission: TBD

Subarea A: (3) 10ft x 25ft

Subarea B: (2) 10ft x 25ft

Subarea C: (2) 10ft x 25ft

Maximum Building Height:

Subarea A: 288ft - 0in

Subarea B: 178ft - 0in

Subarea C: 85ft – 0in

Minimum Setbacks: In conformance with the Plans

Applicant: 345 N. Morgan, LLC
Address: 1000 West Carroll / 311 and 345 North Morgan, Chicago, IL
Introduced: March 13, 2019
Plan Commission: TBD

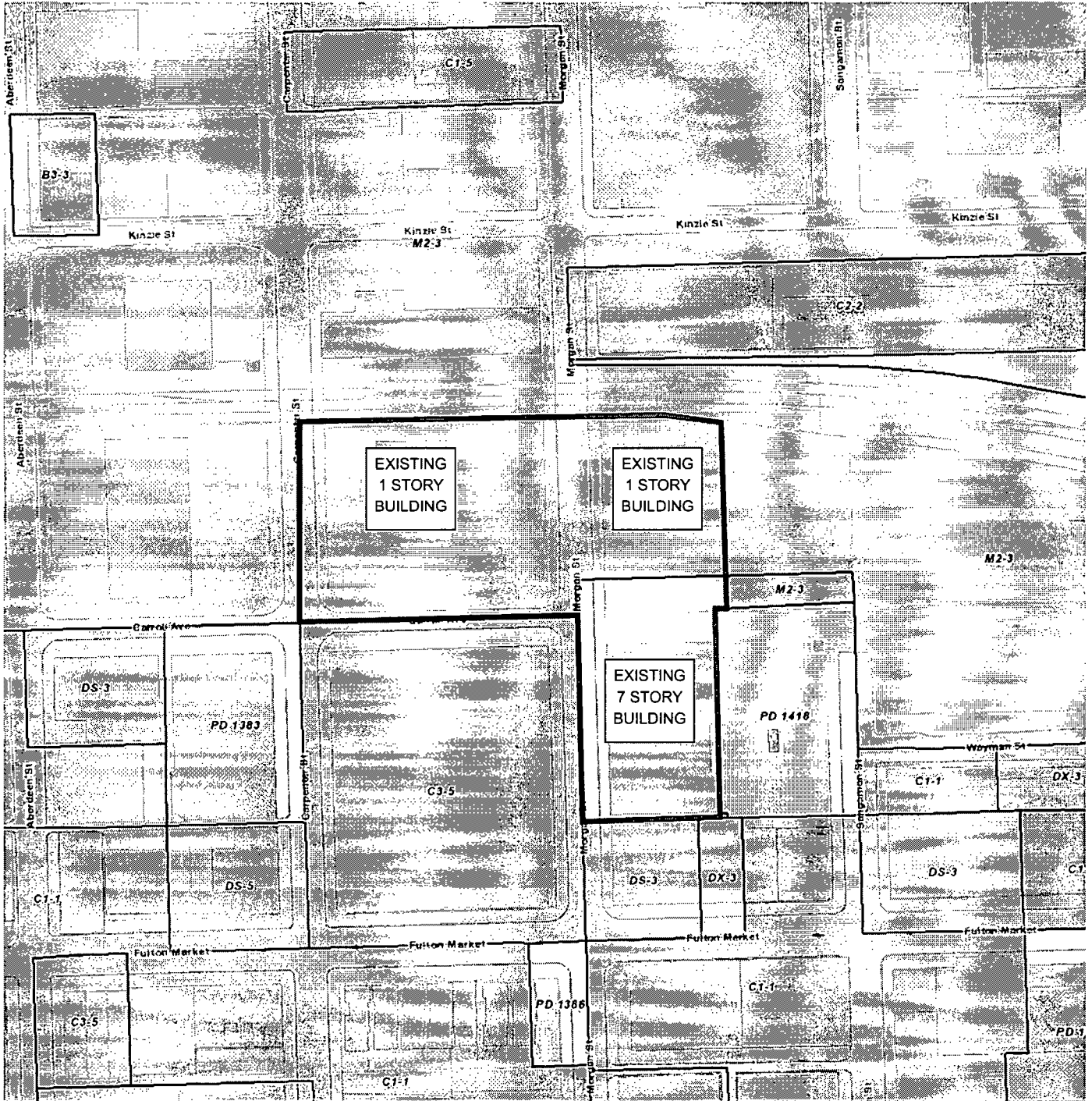

EXISTING ZONING MAP

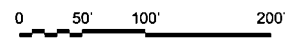

Applicant 345 N Morgan, LLC
 Address 1000 West Carroll / 345 North Morgan / 311 North Morgan
 Introduced March 13, 2019
 Plan Commission TBD

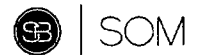

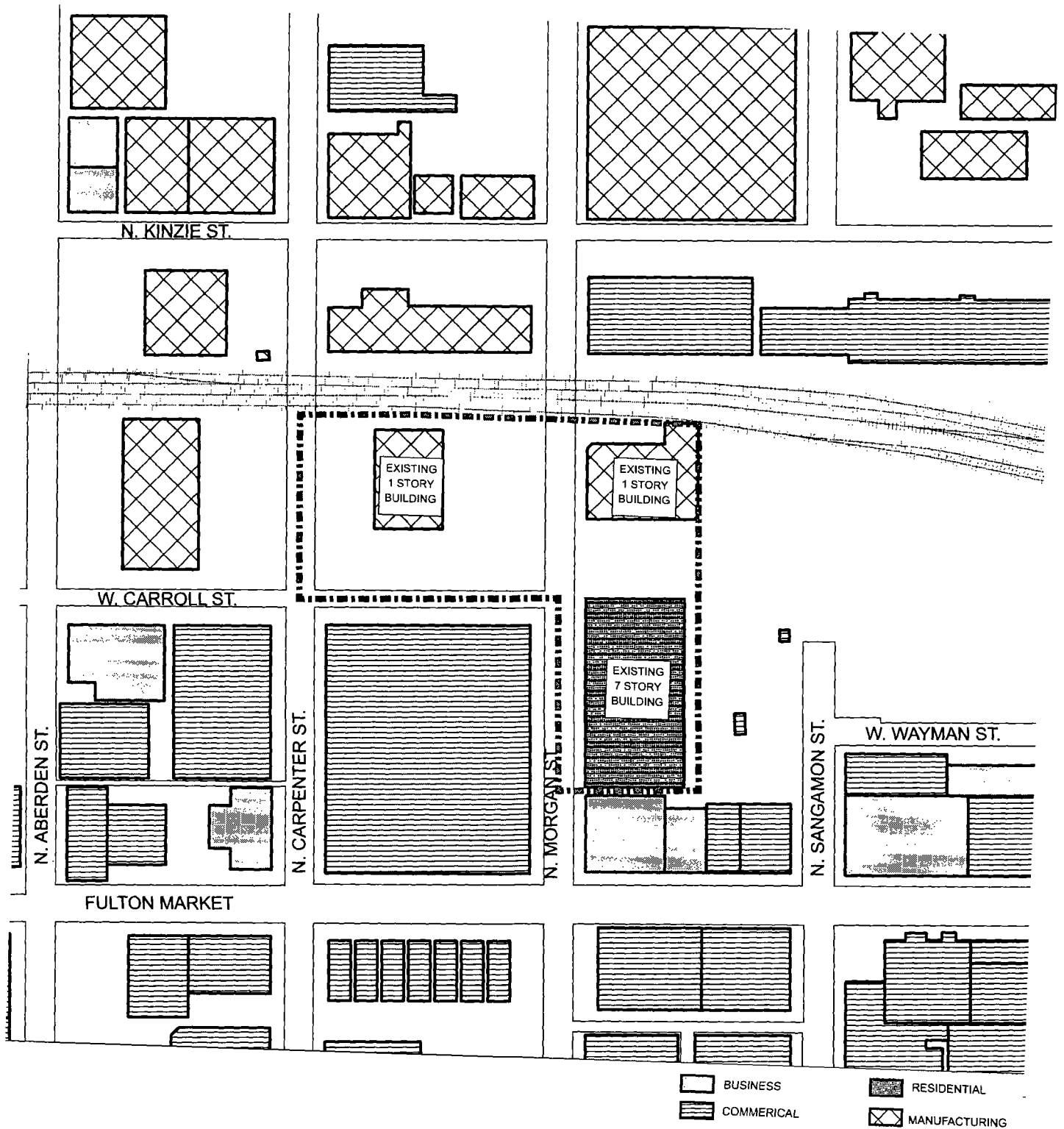

EXISTING LAND USE MAP

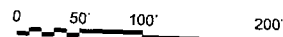

Applicant: 345 N. Morgan, LLC
 Address: 1000 West Carroll / 345 North Morgan / 311 North Morgan
 Introduced: March 13, 2019
 Plan Commission: TBD

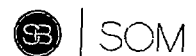

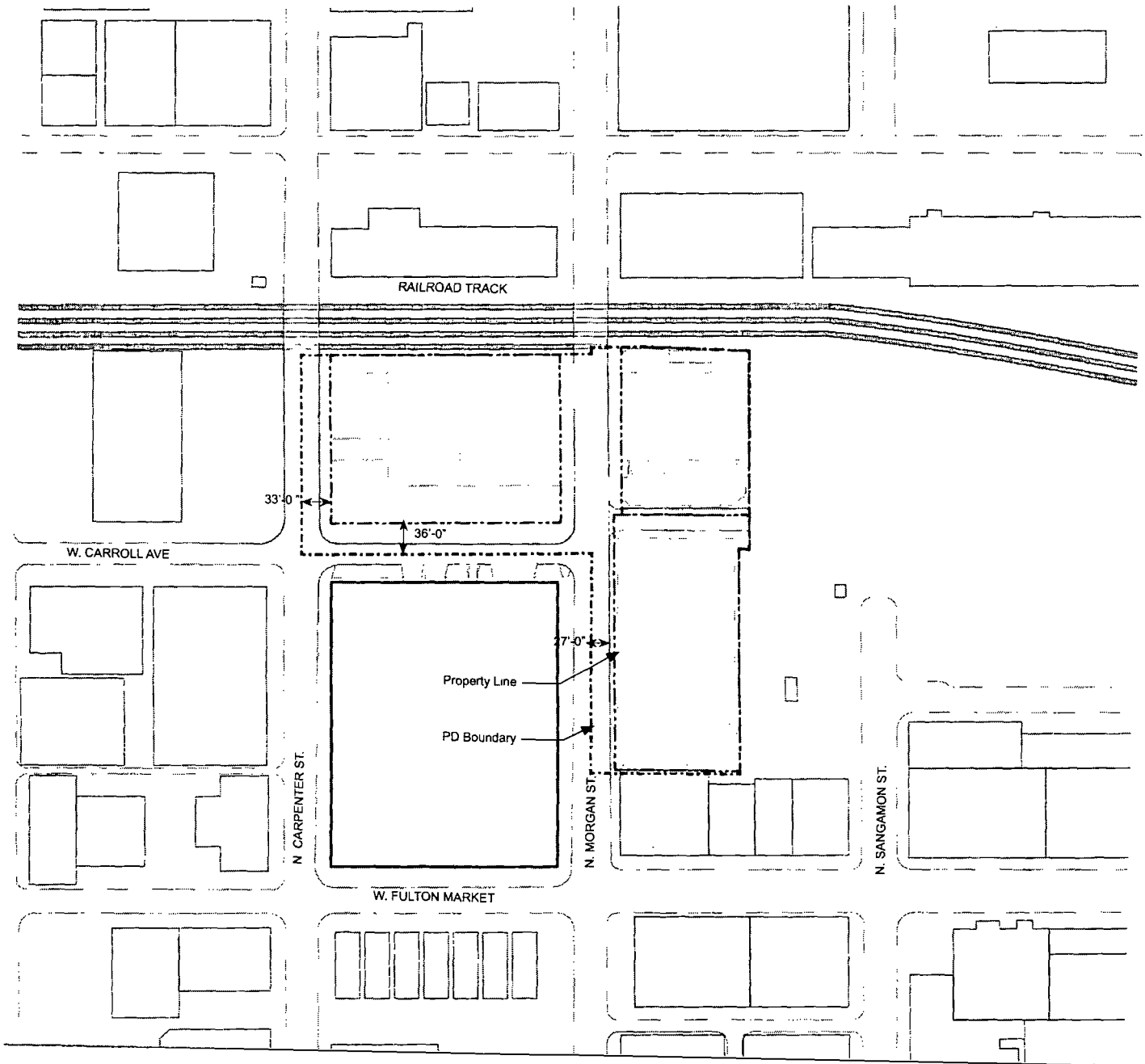

NET SITE AREA = 105,923
 AREA IN RIGHT OF WAY = 37,369
 GROSS SITE AREA = 143,292

PLANNED DEVELOPMENT BOUNDARY

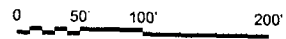

Applicant: 345 N Morgan, LLC
 Address: 1000 West Carroll / 345 North Morgan / 311 North Morgan
 Introduced: March 13, 2019
 Plan Commission: TBD



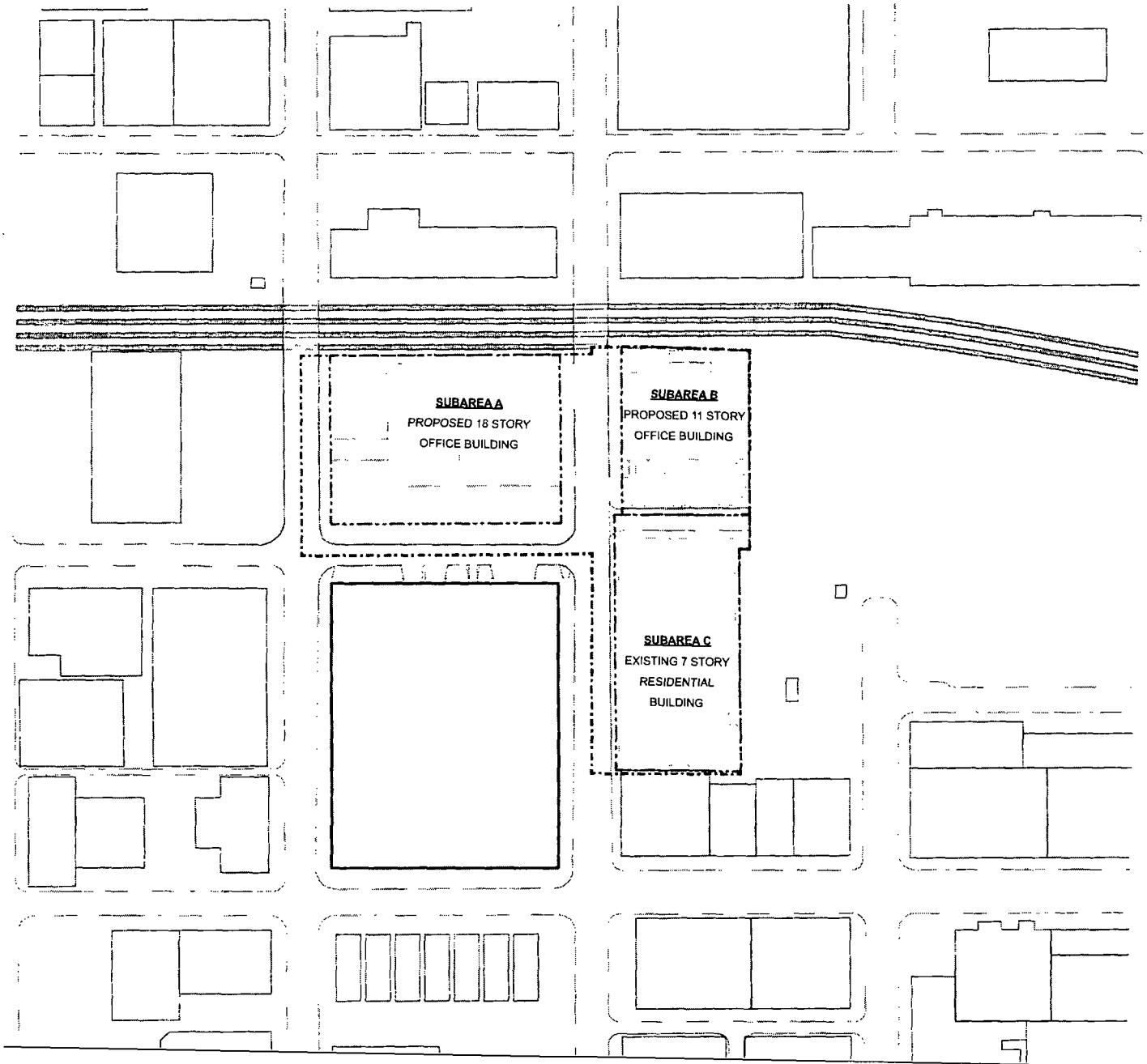

NET SITE AREA = 105,923
 AREA IN RIGHT OF WAY = 37,369
 GROSS SITE AREA = 143,292

SUBAREA MAP

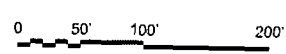

Applicant 345 N Morgan, LLC
 Address 1000 West Carroll / 345 North Morgan / 311 North Morgan
 Introduced March 13, 2019
 Plan Commission TBD



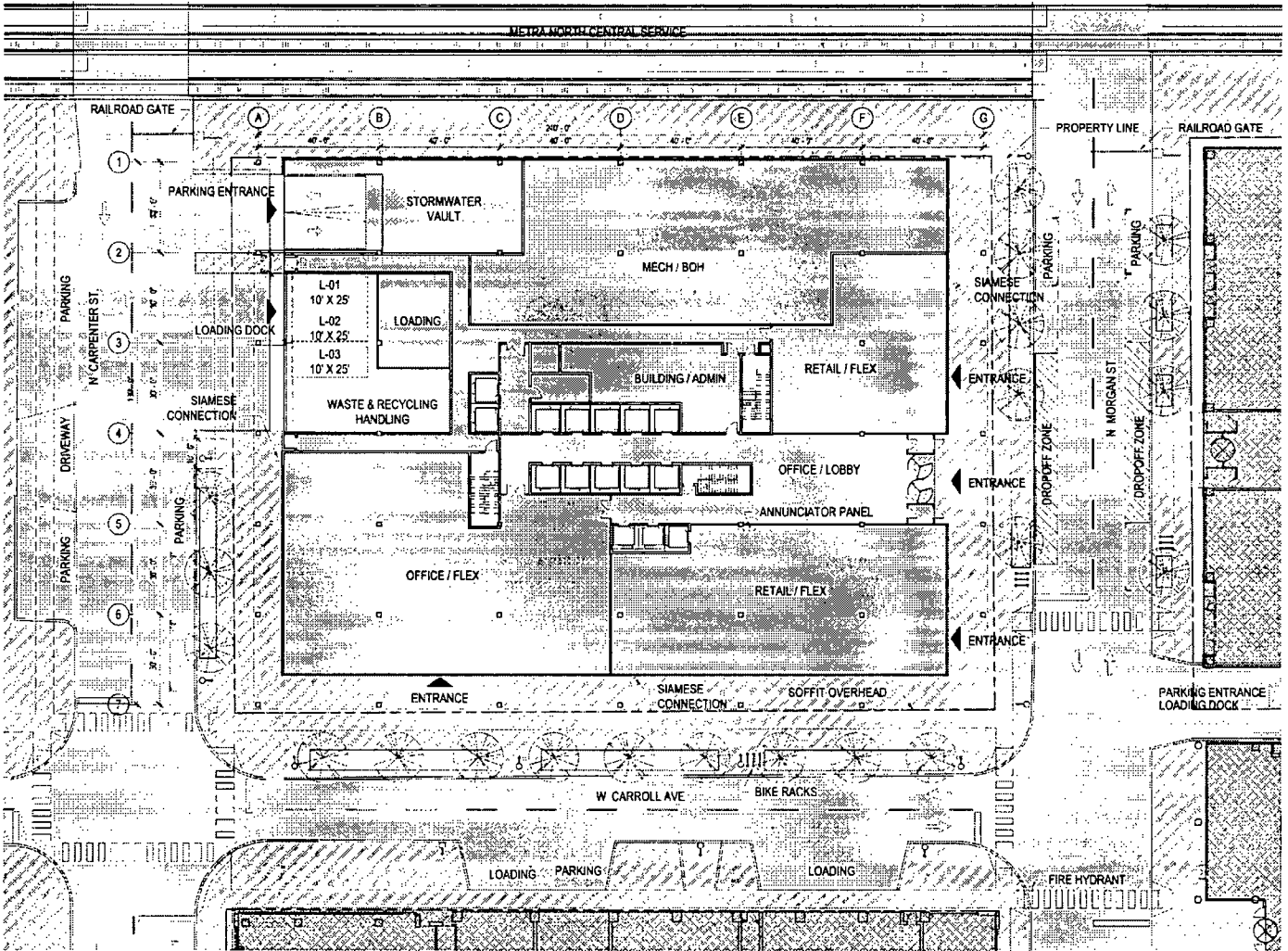

SUBAREA A

SITE / LANDSCAPE PLAN

0 10' 20' 50' 100'



Applicant 345 N Morgan, LLC
 Address 1000 West Carroll / 345 North Morgan / 311 North Morgan
 Introduced March 13, 2019
 Plan Commission TBD

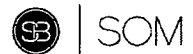

Updated February 25, 2019

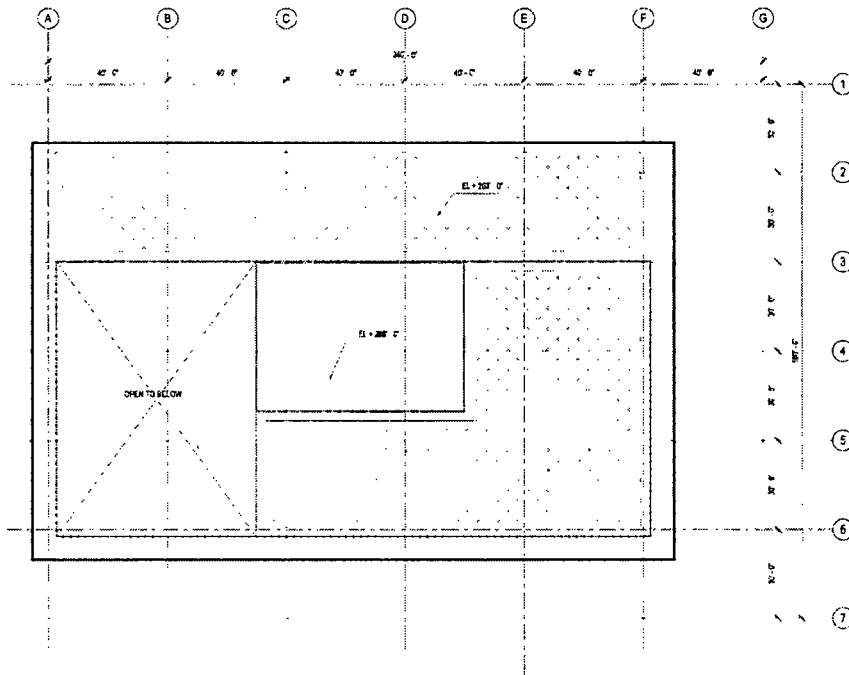

SUBAREA A

TOTAL NON-MECHANICAL ROOF AREA= 11,610 SF
 TOTAL GREEN ROOF AREA= 7,140 SF
GREEN ROOF AREA > 50% TOTAL NON-MECHANICAL ROOF AREA

ROOF PLAN



Applicant. 345 N. Morgan, LLC
 Address. 1000 West Carroll / 345 North Morgan / 311 North Morgan
 Introduced: March 13, 2019
 Plan Commission TBD



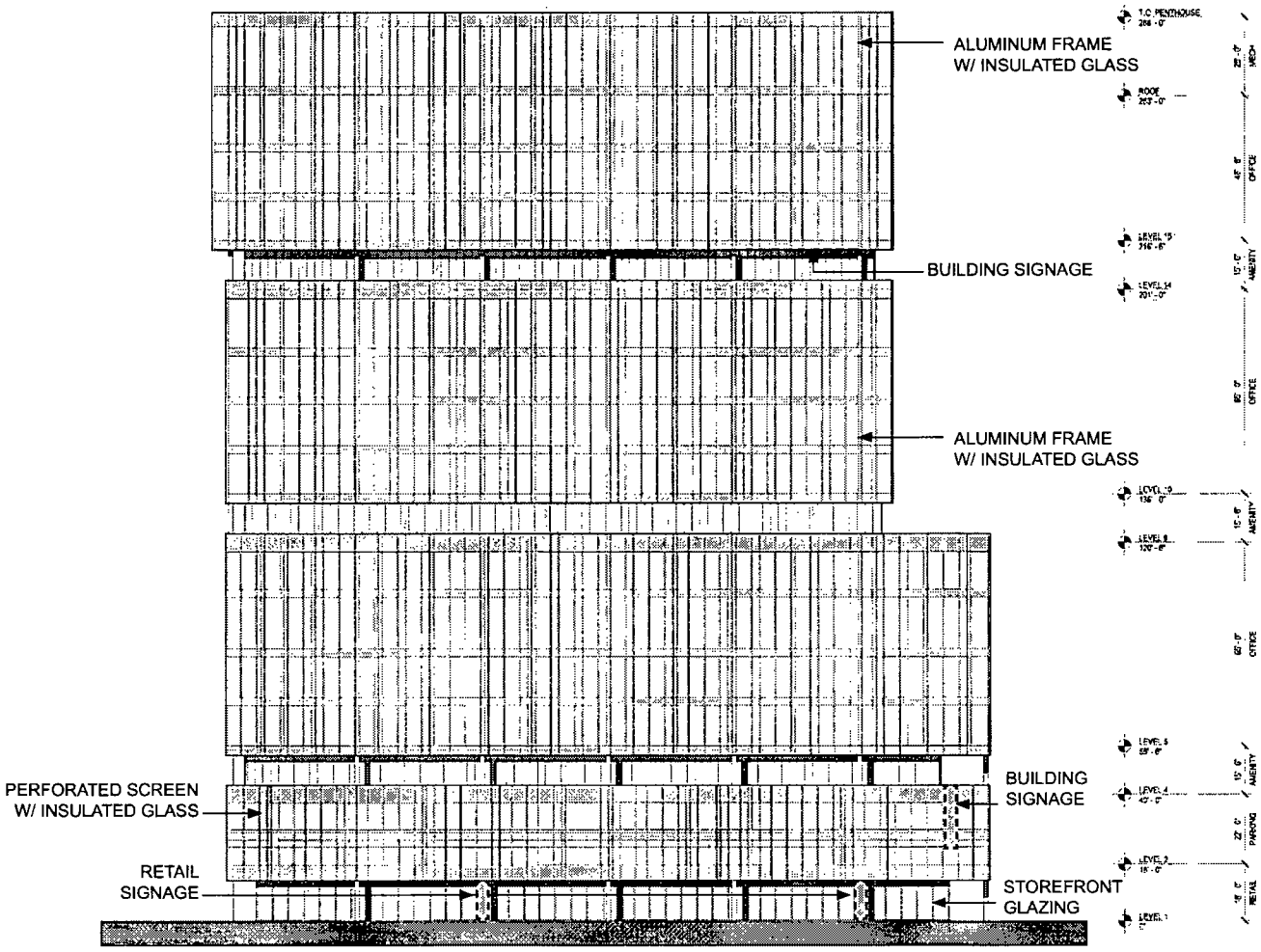

SUBAREA A

SOUTH ELEVATION



Applicant. 345 N. Morgan, LLC
 Address 1000 West Carroll / 345 North Morgan / 311 North Morgan
 Introduced March 13, 2019
 Plan Commission. TBD

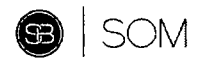

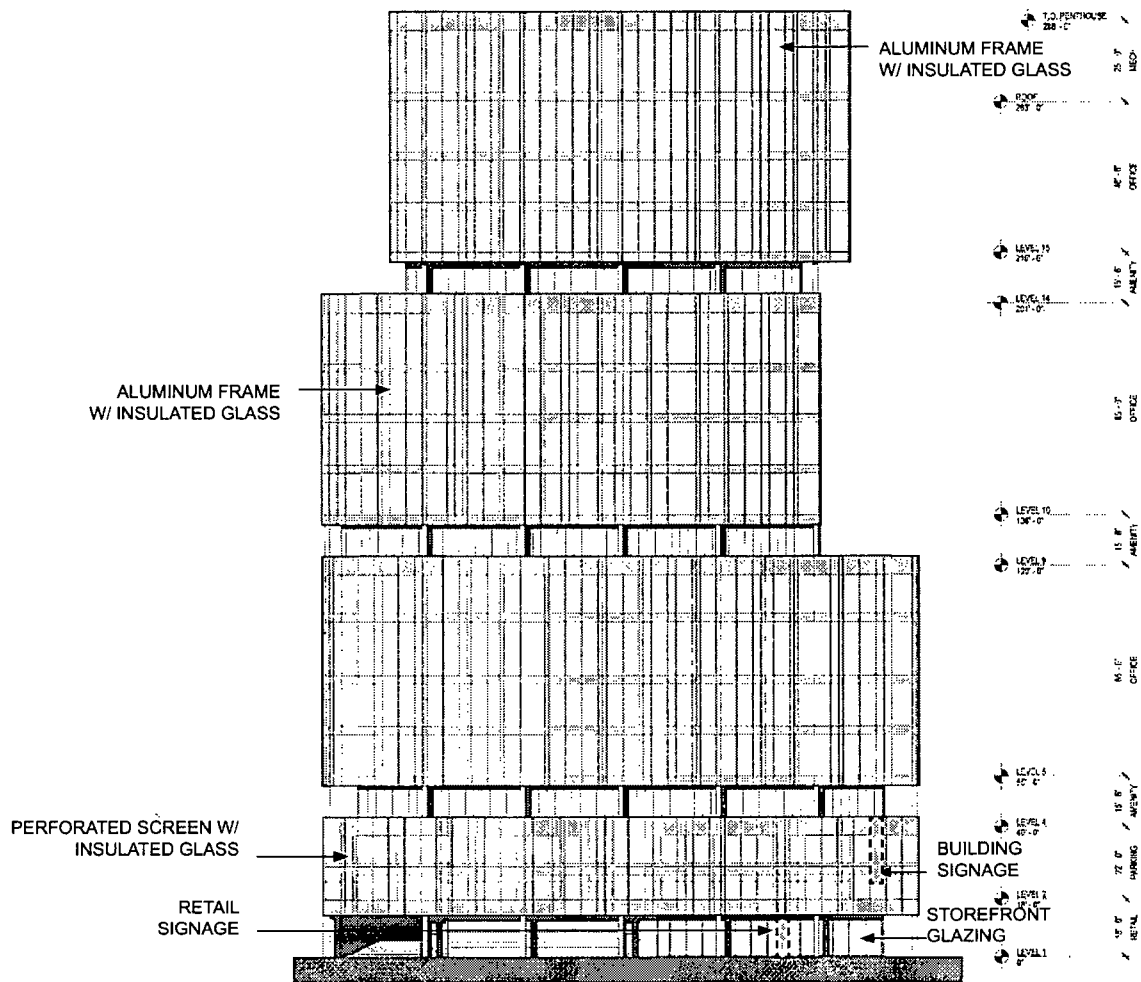

SUBAREA A

WEST ELEVATION



Applicant: 345 N Morgan, LLC
 Address: 1000 West Carroll / 345 North Morgan / 311 North Morgan
 Introduced: March 13, 2019
 Plan Commission: TBD

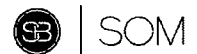

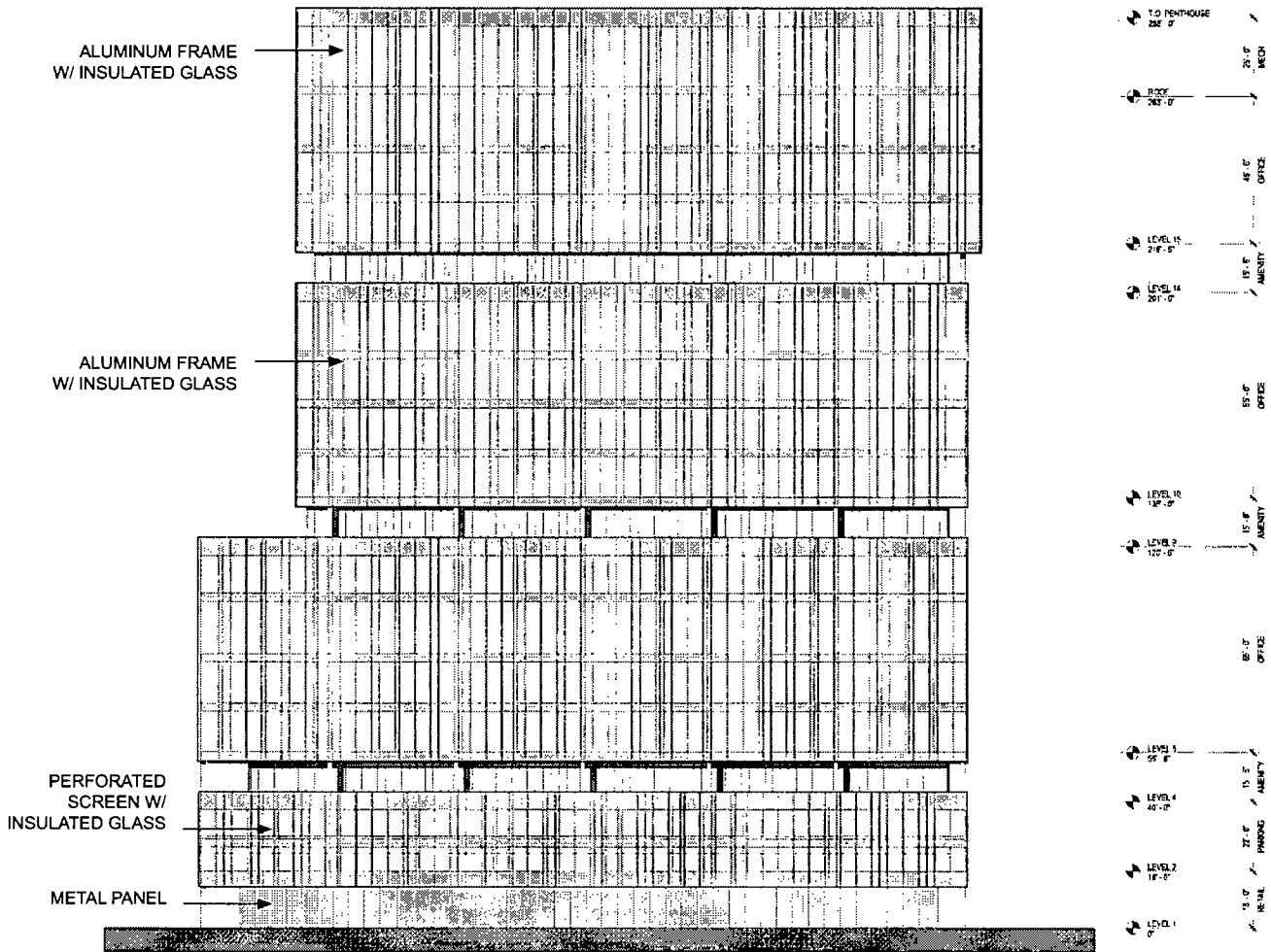

SUBAREA A

NORTH ELEVATION



Applicant 345 N. Morgan, LLC
 Address 1000 West Carroll / 345 North Morgan / 311 North Morgan
 Introduced: March 13, 2019
 Plan Commission: TBD

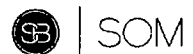

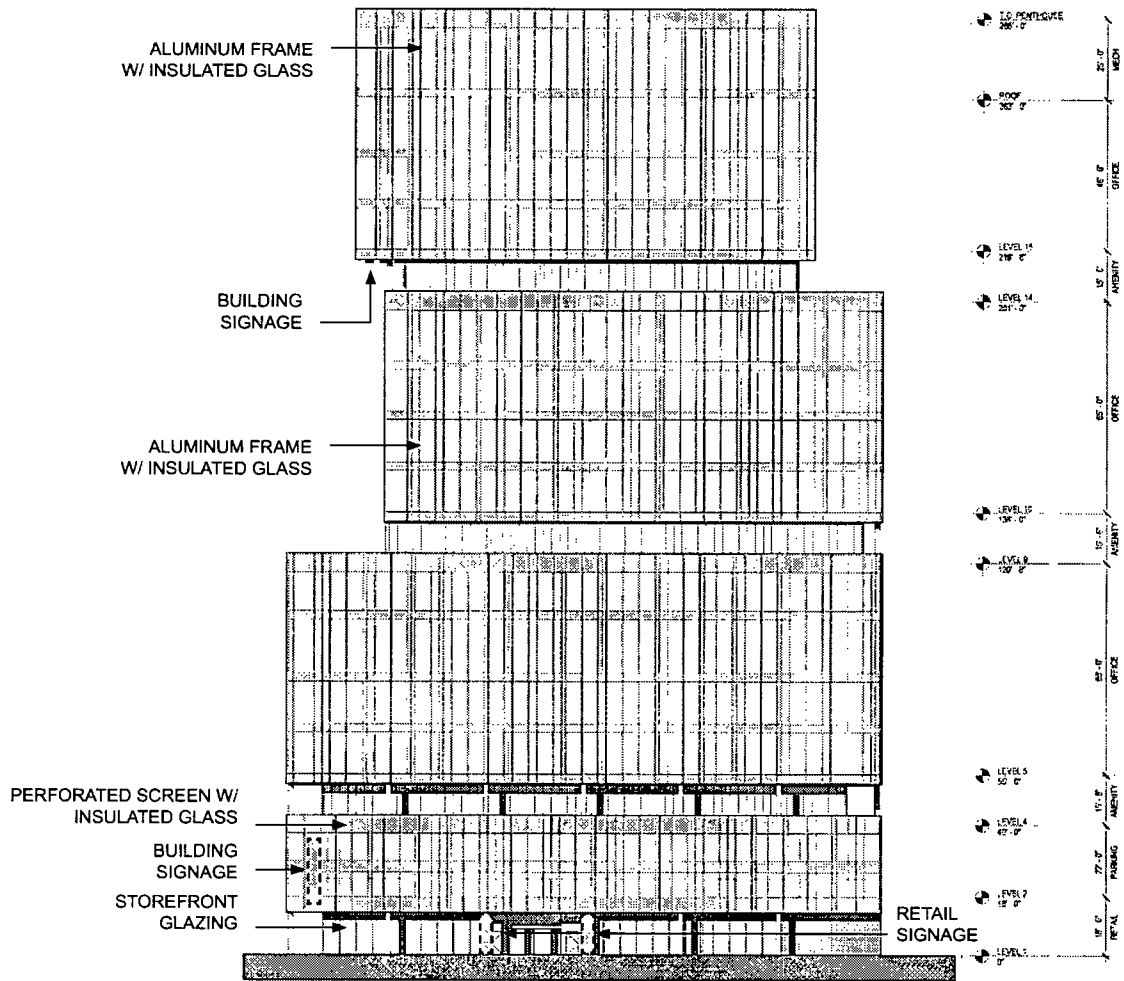

SUBAREA A

EAST ELEVATION



Applicant: 345 N Morgan, LLC
 Address: 1000 West Carroll / 345 North Morgan / 311 North Morgan
 Introduced: March 13, 2019
 Plan Commission: TBD



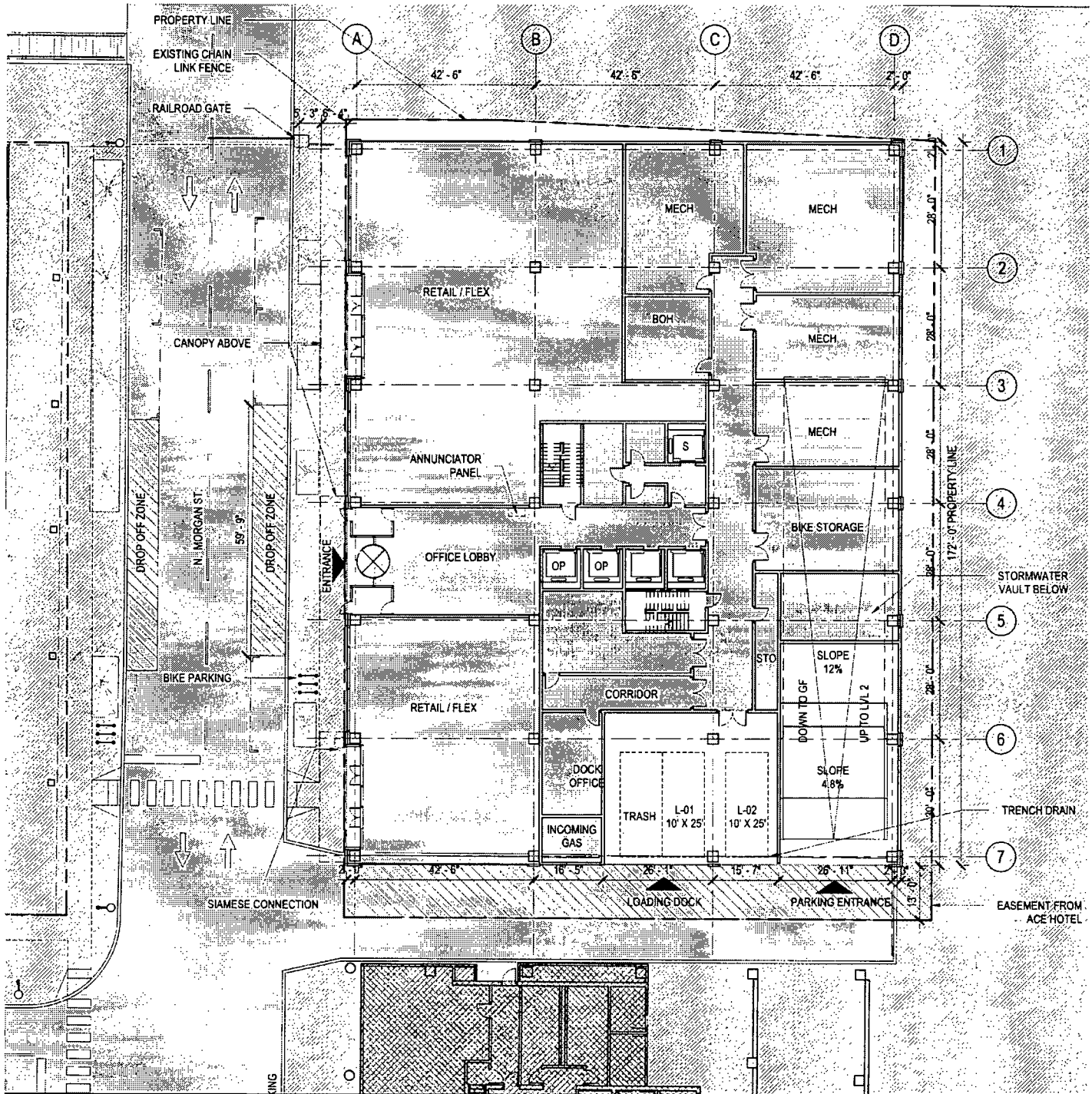

SUBAREA B

SITE / LANDSCAPE PLAN

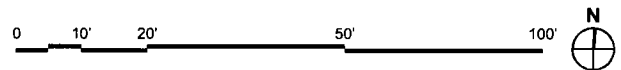

Applicant: 345 N Morgan, LLC
 Address: 1000 West Carroll / 345 North Morgan / 311 North Morgan
 Introduced: March 13, 2019
 Plan Commission: TBD

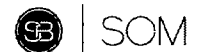

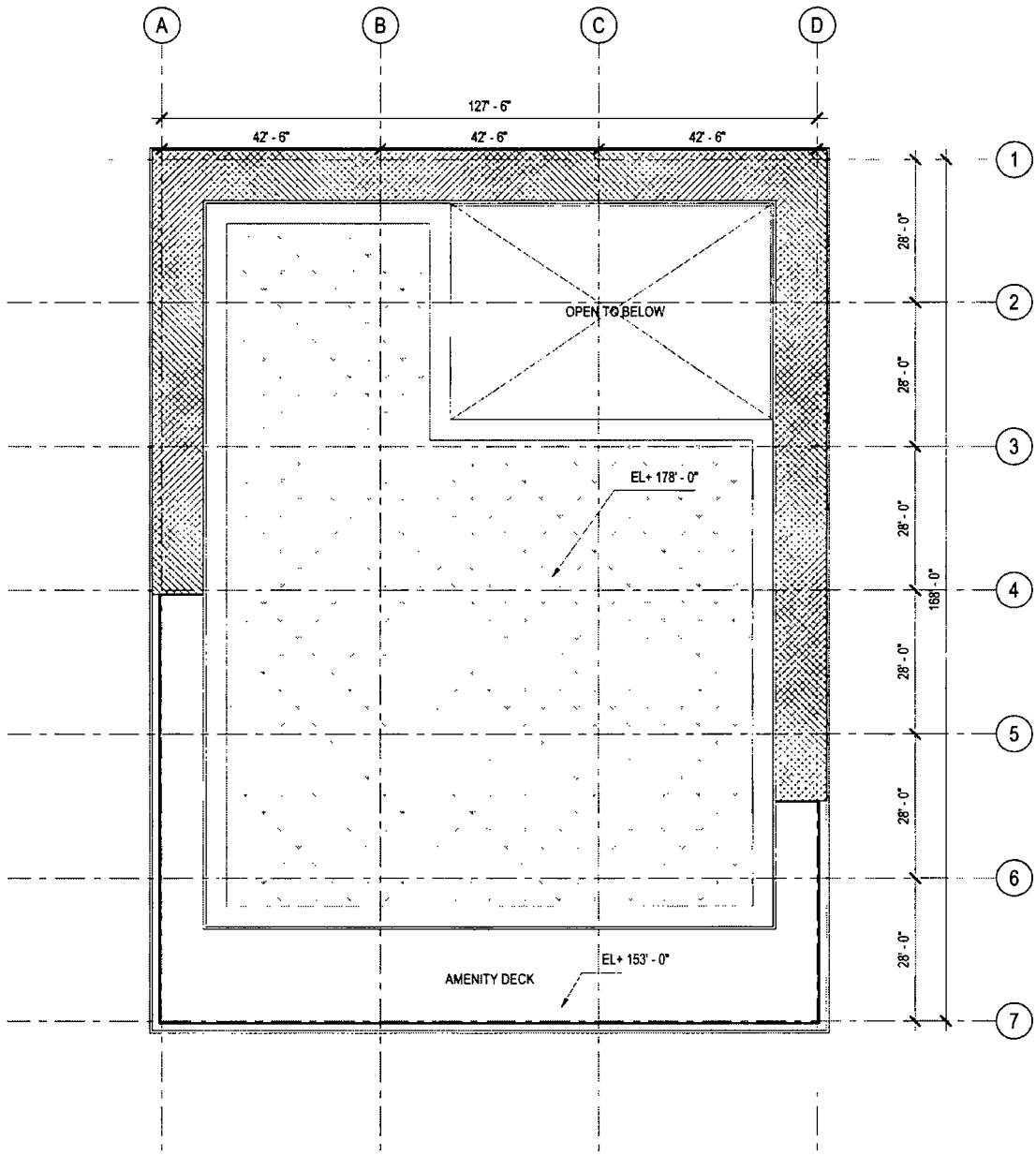

SUBAREA B

TOTAL NON-MECHANICAL ROOF AREA= 19,850 SF
 TOTAL GREEN ROOF AREA= 11,000 SF
 GREEN ROOF AREA > 50% TOTAL NON-MECHANICAL ROOF AREA

ROOF PLAN

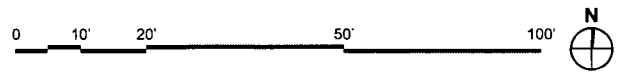

Applicant: 345 N. Morgan, LLC
 Address: 1000 West Carroll / 345 North Morgan / 311 North Morgan
 Introduced: March 13, 2019
 Plan Commission: TBD



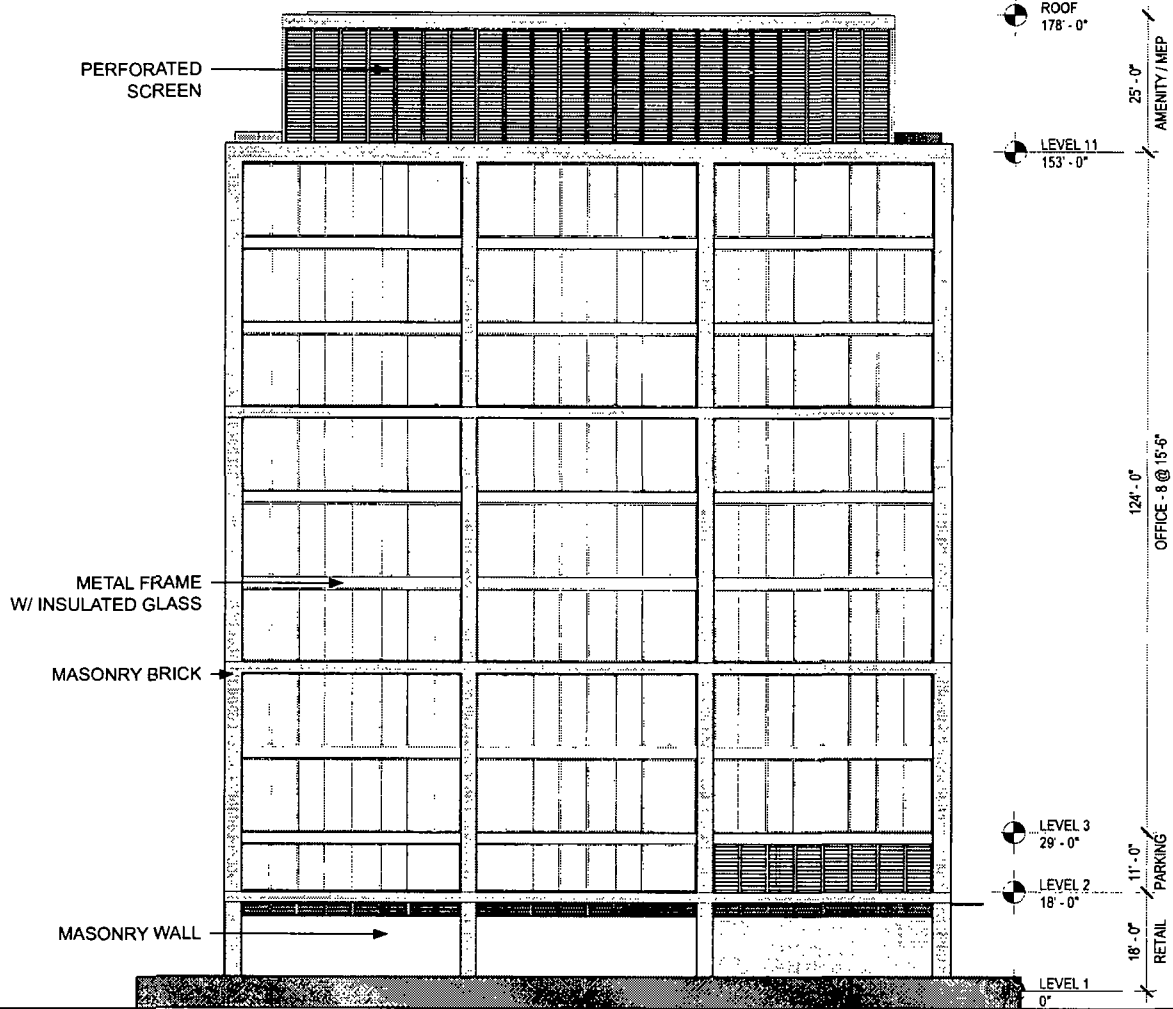

SUBAREA B

NORTH ELEVATION



Applicant 345 N. Morgan, LLC
 Address 1000 West Carroll / 345 North Morgan
 Introduced March 13, 2019
 Plan Commission TBD



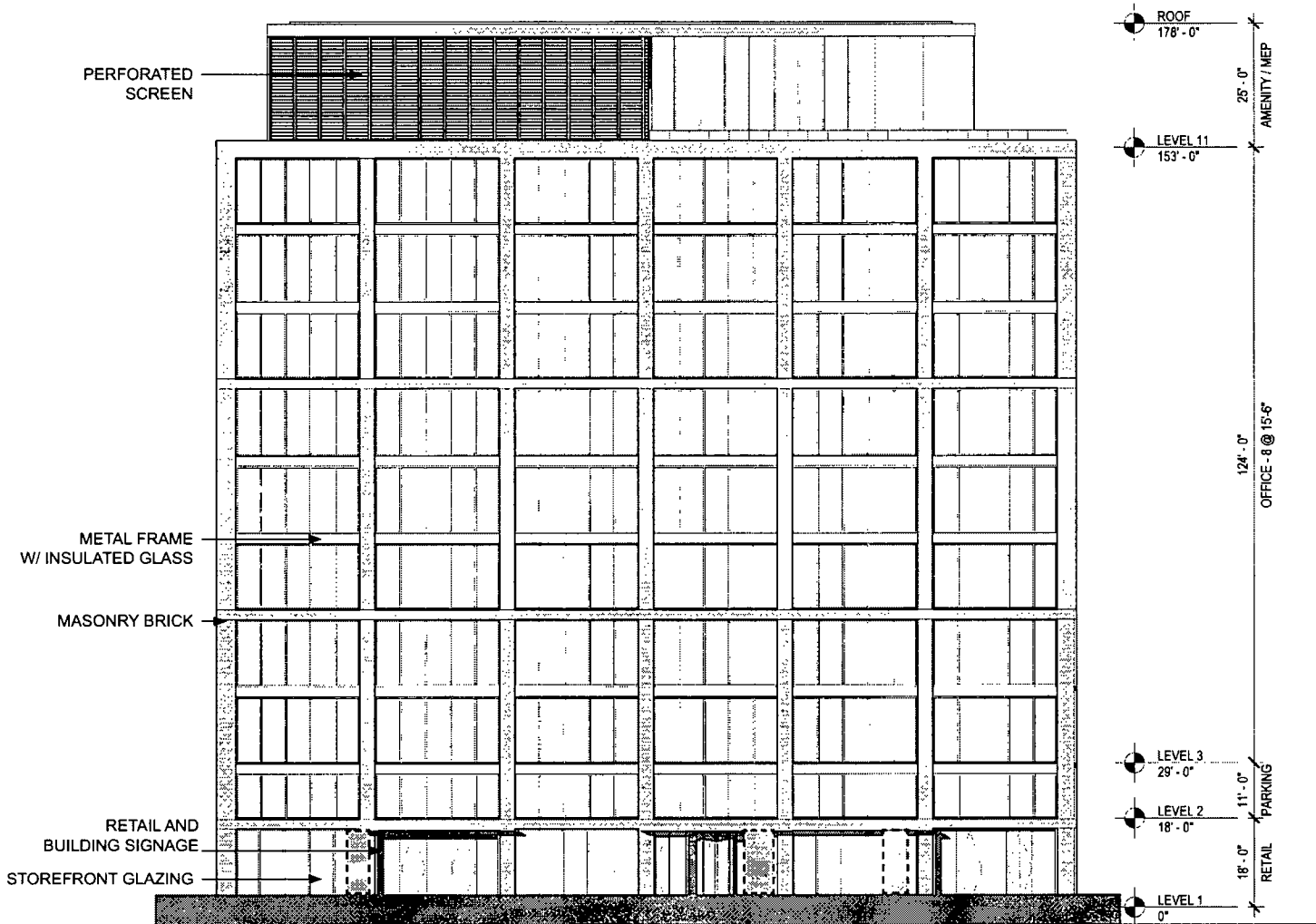

SUBAREA B

WEST ELEVATION



Applicant: 345 N Morgan, LLC
 Address: 1000 West Carroll / 345 North Morgan
 Introduced: March 13, 2019
 Plan Commission: TBD

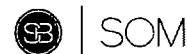

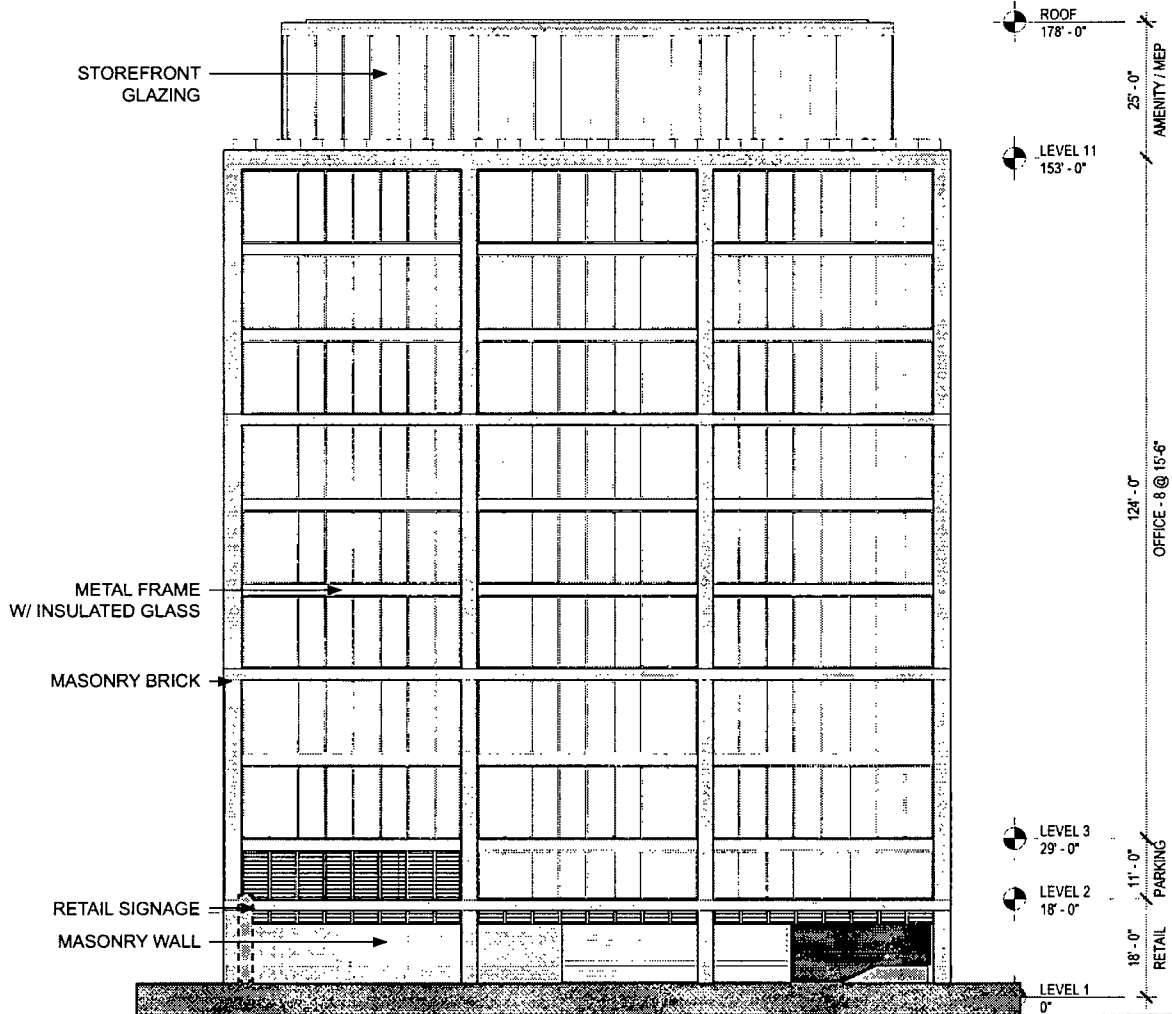

SUBAREA B

SOUTH ELEVATION



Applicant 345 N. Morgan, LLC
 Address 1000 West Carroll / 345 North Morgan
 Introduced: March 13, 2019
 Plan Commission TBD



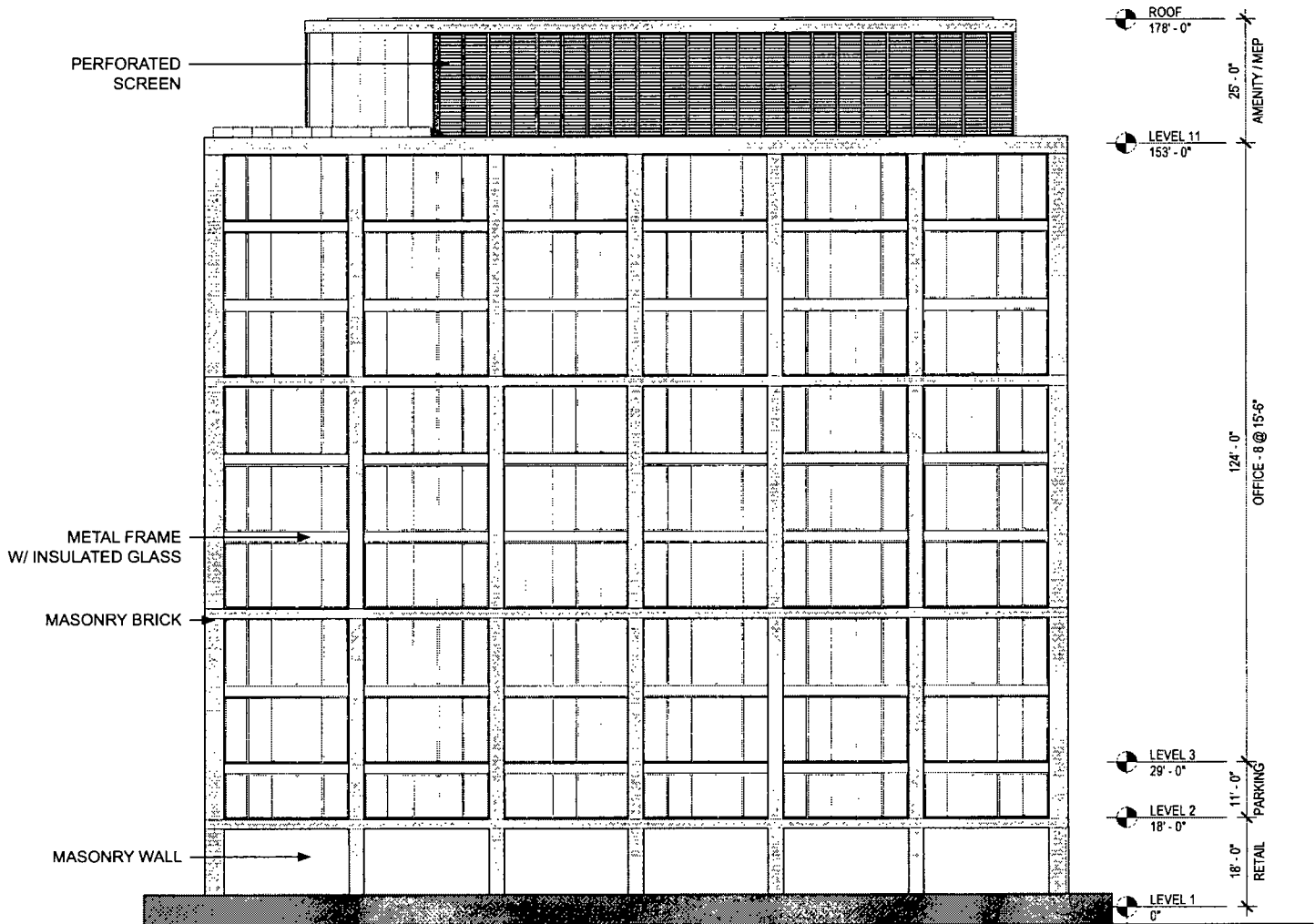

SUBAREA B

EAST ELEVATION



Applicant. 345 N Morgan, LLC
 Address. 1000 West Carroll / 345 North Morgan
 Introduced. March 13, 2019
 Plan Commission. TBD



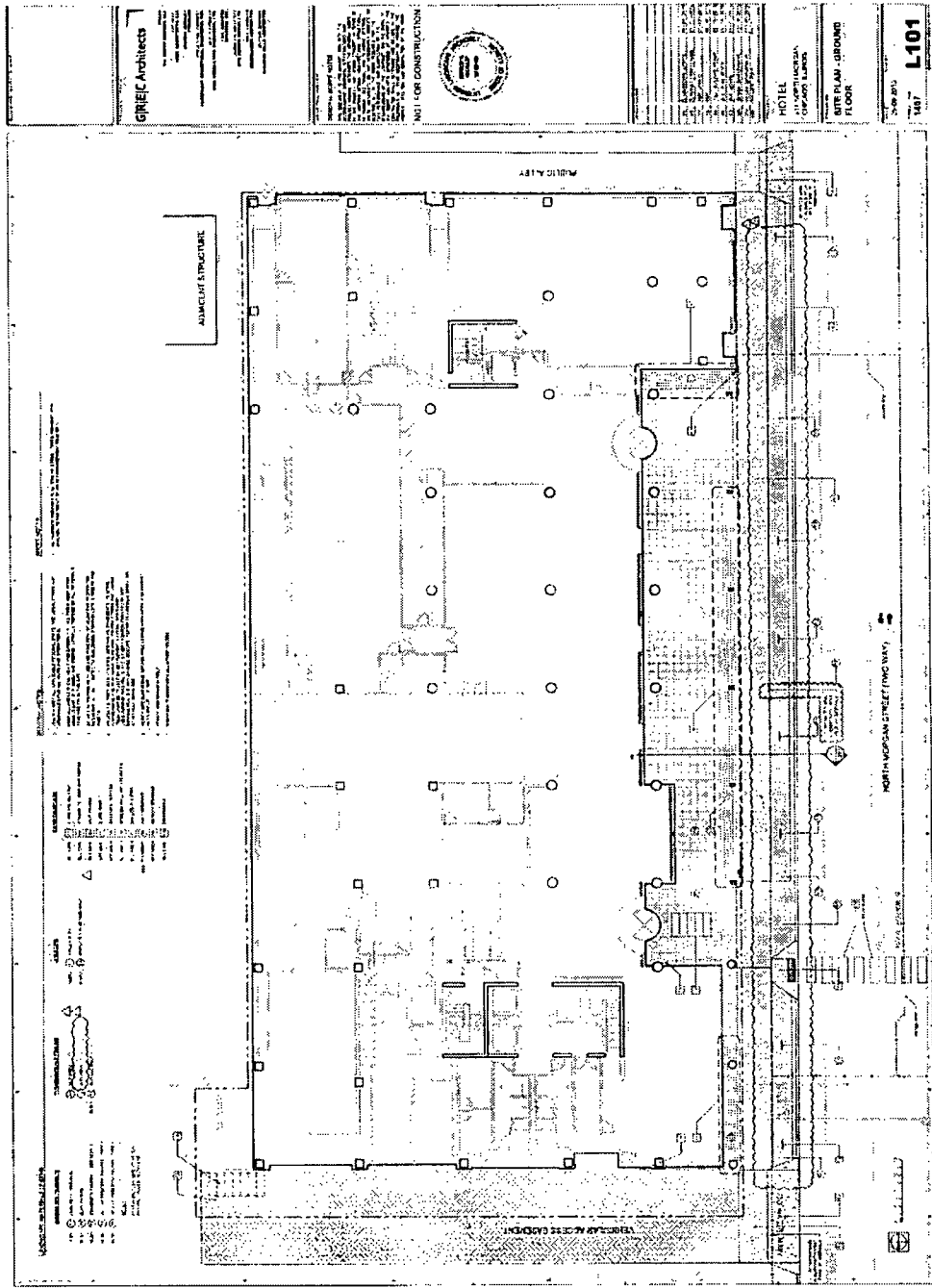

SUBAREA C



Applicant. 345 N. Morgan, LLC
 Address. 1000 West Carroll / 345 North Morgan / 311 North Morgan
 Introduced. March 13, 2019
 Plan Commission. TBD



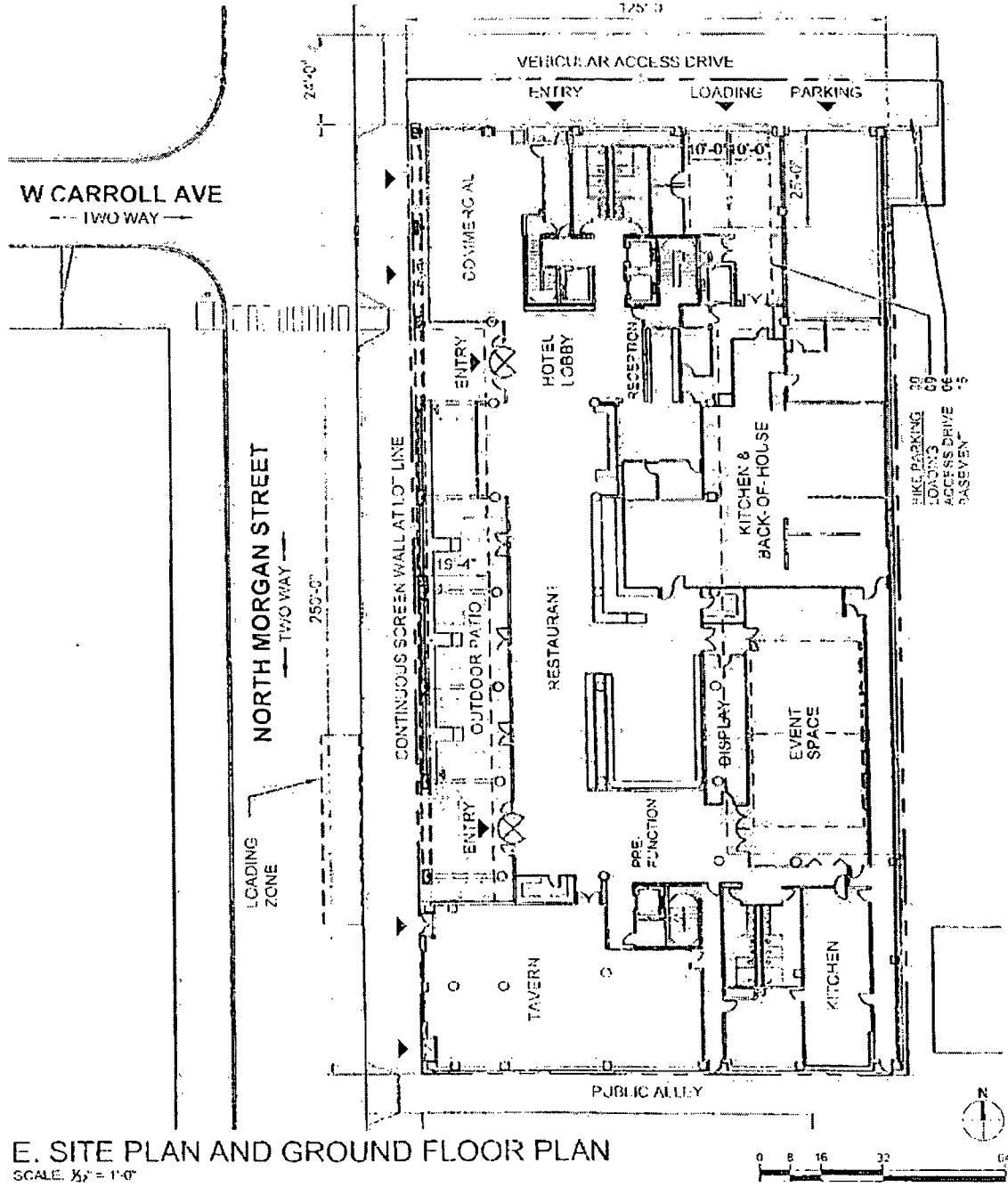

E. SITE PLAN AND GROUND FLOOR PLAN
 SCALE: 1/8" = 1'-0"

SUBAREA C

Applicant: 345 N Morgan, LLC
 Address: 1000 West Carroll / 345 North Morgan / 311 North Morgan
 Introduced: March 13, 2019
 Plan Commission: TBD



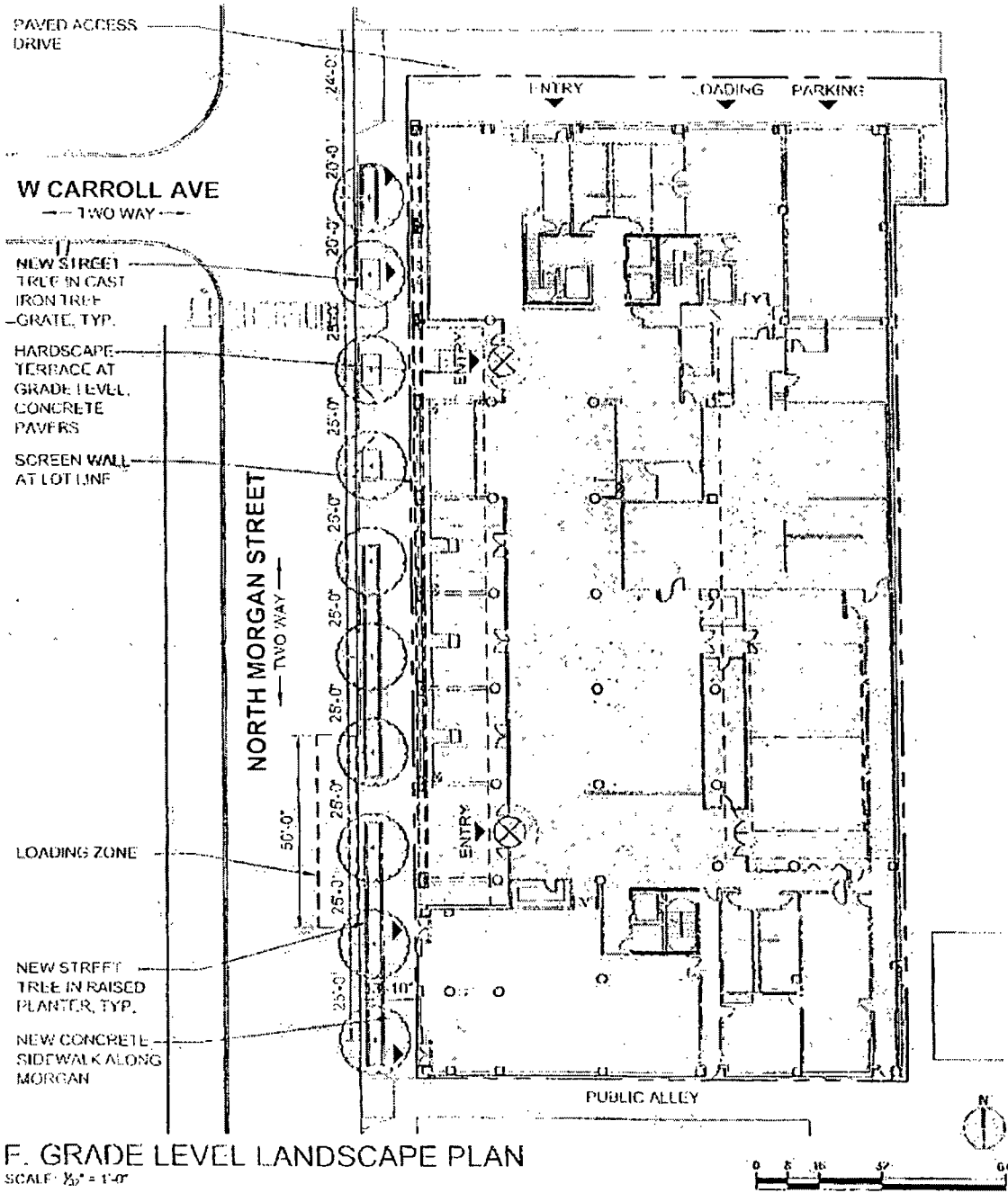

F. GRADE LEVEL LANDSCAPE PLAN
 SCALE: 1/8" = 1'-0"

SUBAREA C



Applicant: 345 N. Morgan, LLC
 Address: 1000 West Carroll / 345 North Morgan / 311 North Morgan
 Introduced: March 13, 2019
 Plan Commission: TBD

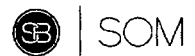

FINAL FOR PUBLICATION

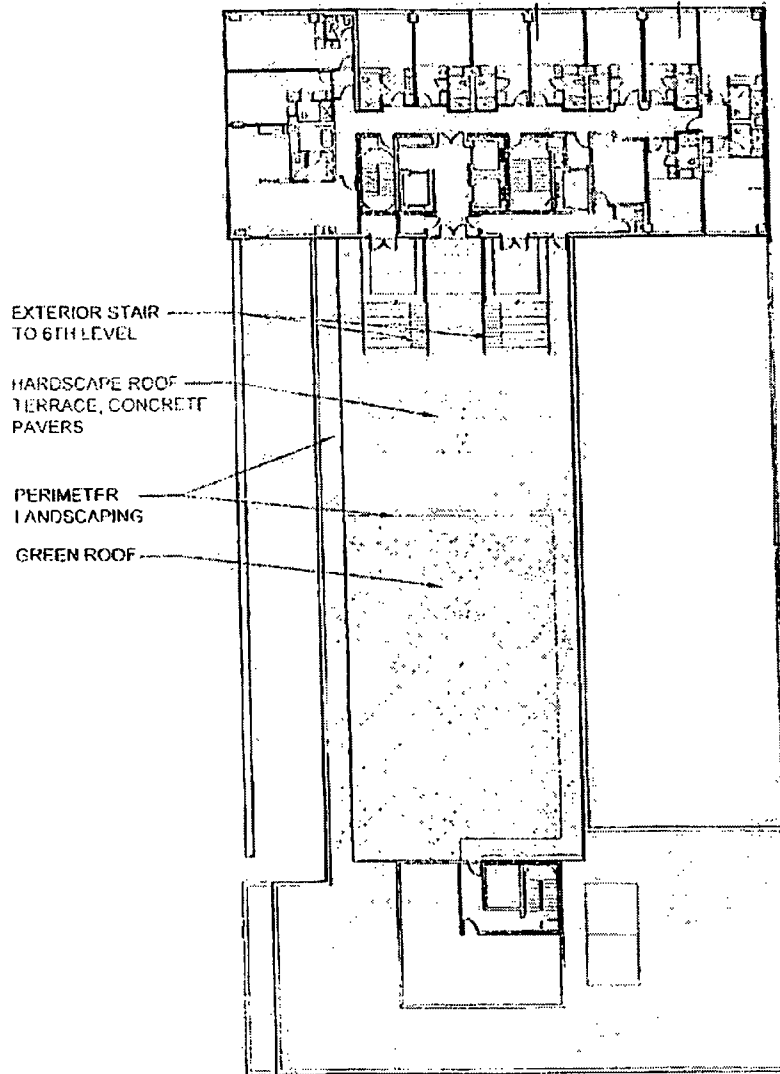

G. FIFTH LEVEL TERRACE LANDSCAPE PLAN
 SCALE: 1/32" = 1'-0"

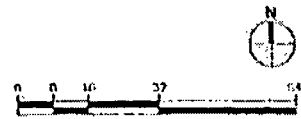

SUBAREA C



Applicant: 345 N Morgan, LLC
 Address: 1000 West Carroll / 345 North Morgan / 311 North Morgan
 Introduced: March 13, 2019
 Plan Commission: TBD

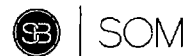

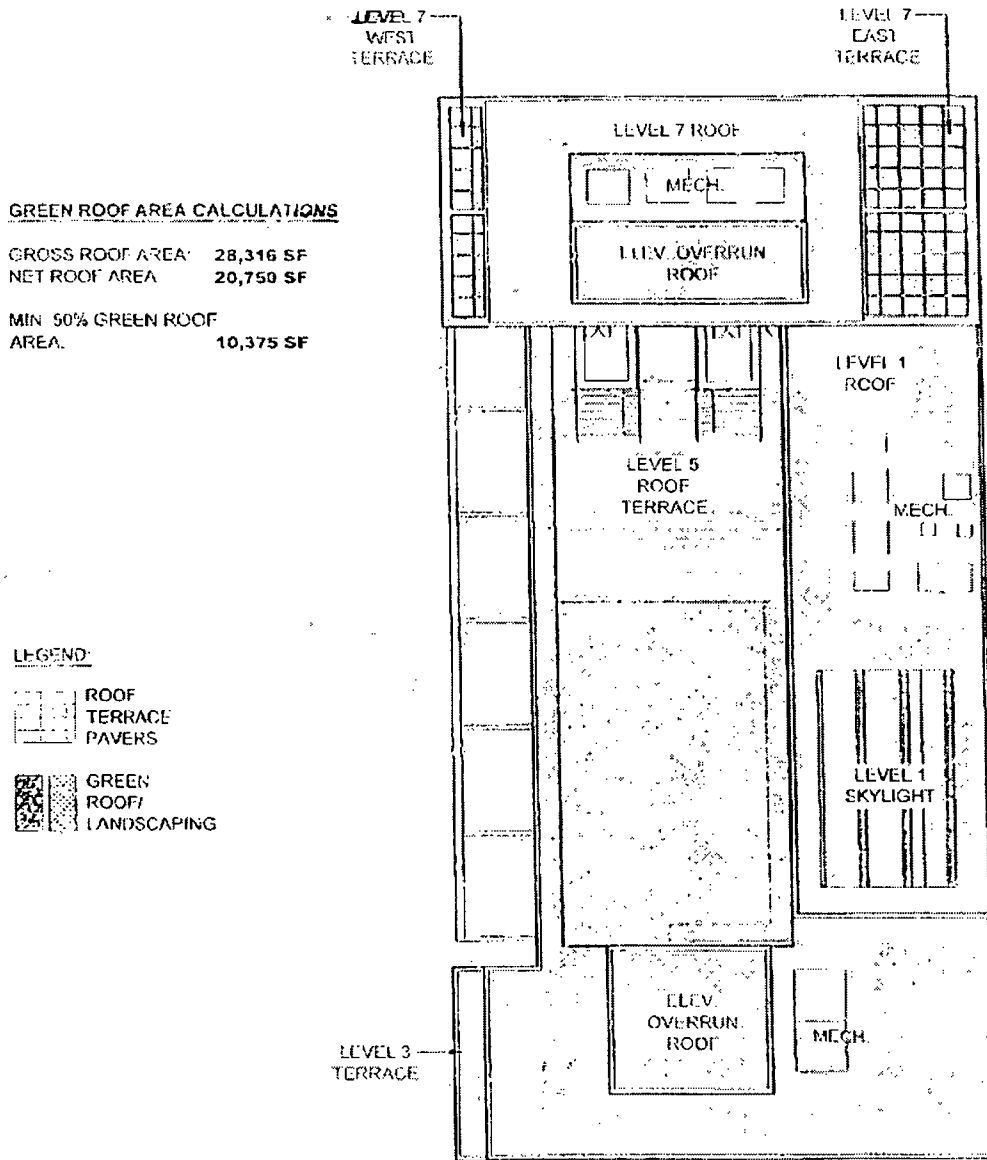

H. GREEN ROOF DIAGRAM
SCALE 1/2" = 1'-0"

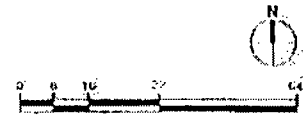

SUBAREA C



Applicant: 345 N Morgan, LLC
 Address: 1000 West Carroll / 345 North Morgan / 311 North Morgan
 Introduced: March 13, 2019
 Plan Commission: TBD

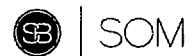

FINAL FOR PUBLICATION

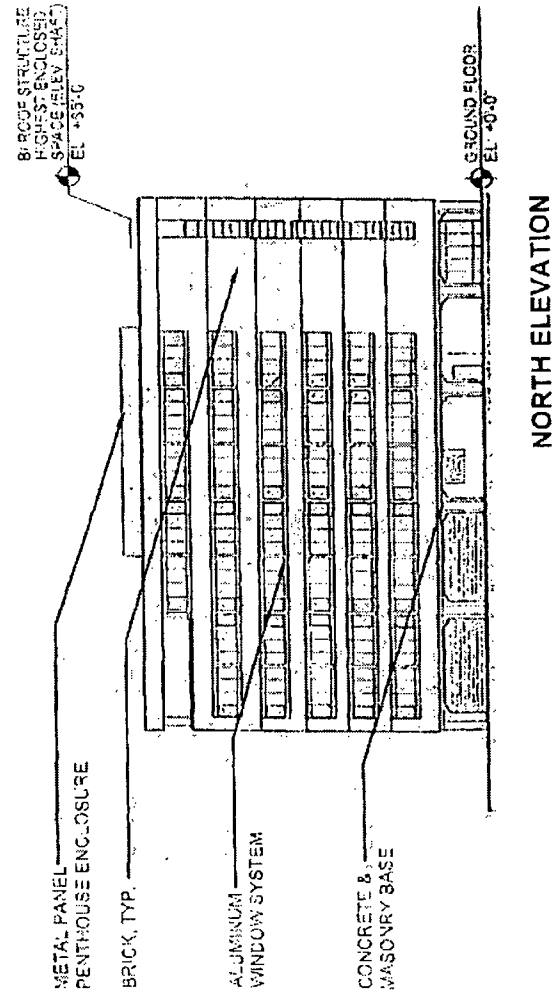

J4. NORTH ELEVATION
 SCALE: 1/4" = 1'-0"

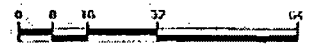

SUBAREA C

Applicant: 345 N Morgan, LLC
 Address: 1000 West Carroll / 345 North Morgan / 311 North Morgan
 Introduced: March 13, 2019
 Plan Commission: TBD



FINAL FOR PUBLICATION

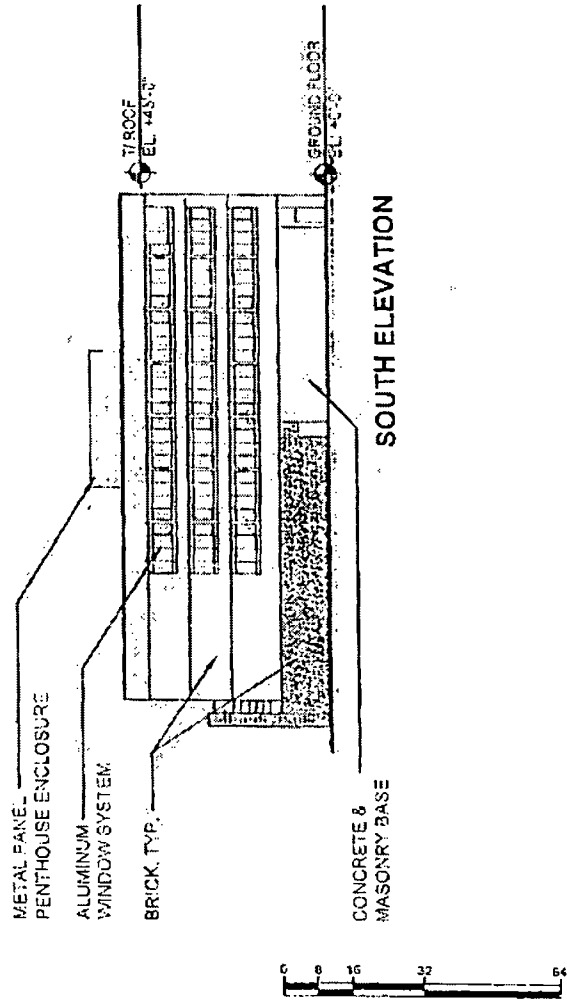

J2. SOUTH ELEVATION
 SCALE 1/32" = 1'-0"

SUBAREA C

Applicant. 345 N. Morgan, LLC
 Address 1000 West Carroll / 345 North Morgan / 311 North Morgan
 Introduced March 13, 2019
 Plan Commission. TBD



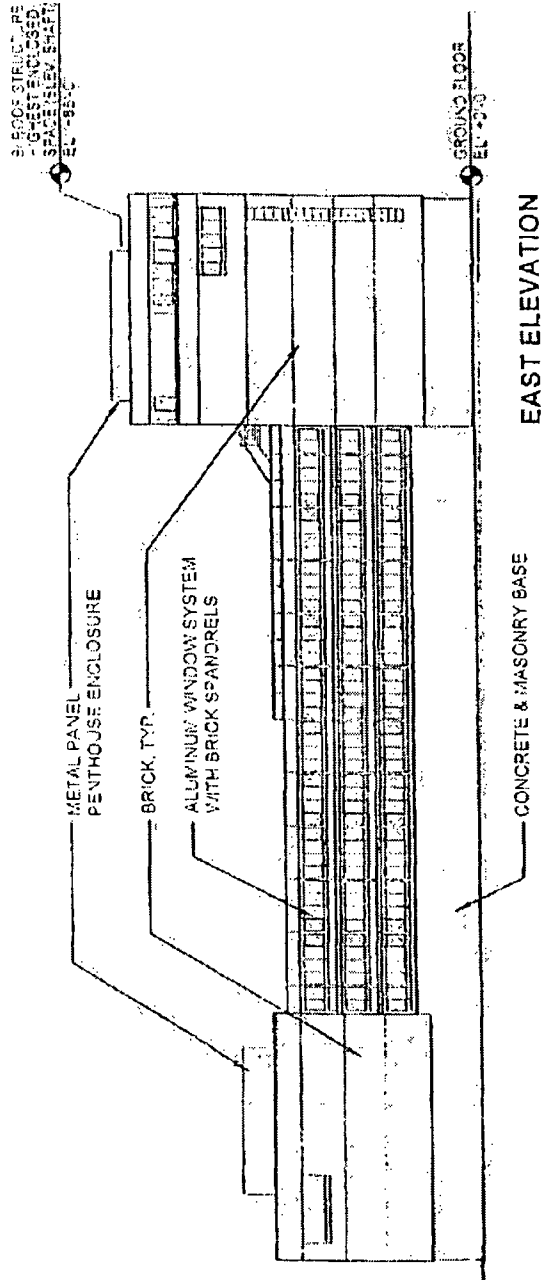

J3. EAST ELEVATION
 SCALE 1/32" = 1'-0"

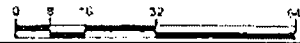

SUBAREA C

Applicant: 345 N. Morgan, LLC
 Address: 1000 West Carroll / 345 North Morgan / 311 North Morgan
 Introduced: March 13, 2019
 Plan Commission: TBD



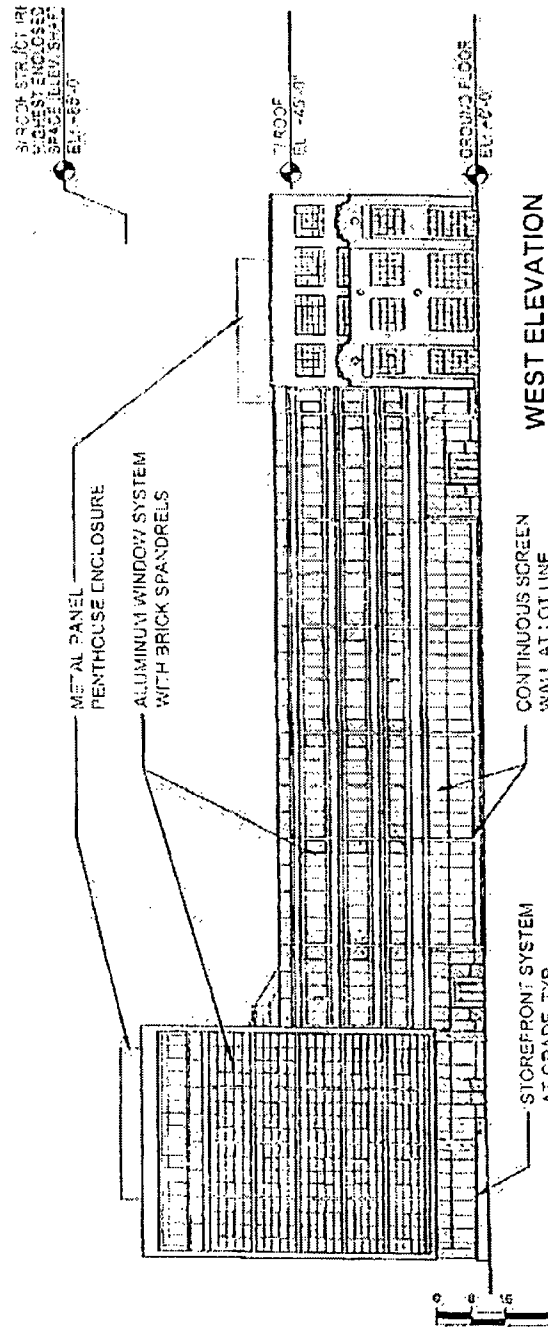

J1. WEST ELEVATION
 SCALE: 1/2" = 1'-0"



SUBAREA C

Applicant 345 N Morgan, LLC
 Address 1000 West Carroll / 345 North Morgan / 311 North Morgan
 Introduced, March 13, 2019
 Plan Commission. TBD





DLA Piper LLP (US)
444 West Lake Street, Suite 900
Chicago, Illinois 60606
www.dlapiper.com

Richard F. Klawiter
richard.klawiter@dlapiper.com
T 312.368.7243

March 6, 2019

The Honorable James Cappleman, Acting Chair
City of Chicago Committee on Zoning
Room 304, City Hall
121 North LaSalle Street
Chicago, Illinois 60602

Martin Cabrera, Jr., Chairman
City of Chicago Plan Commission
Room 1000, City Hall
121 North LaSalle Street
Chicago, Illinois 60602

**Re: Application for Business Planned Development
1000 West Carroll / 311 and 345 North Morgan**

Dear Acting Chairman Cappleman:

The undersigned, Richard Klawiter, an attorney with the law firm of DLA Piper LLP (US), which firm represents 345 N. Morgan, LLC, the applicant for a proposal to rezone the subject property from the M2-3 Light Industry District and Planned Development Number 1282 to the DX-5 Mixed-Use District then to a Business Planned Development, certifies that he has complied with the requirements for Section 17-13-0107 of the Chicago Zoning Ordinance by sending written notice to such property owners who appear to be the owners of the property within the subject area not solely owned by the applicant, and to the owners of all property within 250 feet of each direction of the lot line of the subject property, exclusive of public roads, streets, alleys and other public ways. Said written notice was sent by First Class U.S. Mail, no more than 30 days before filing the application.

The undersigned certifies that the notice contained the address of the property sought to be rezoned; a statement of the intended use of the property; the name and address of the applicant; the name and address of the owner; a statement that the applicant intends to file the application for change in zoning on approximately March 6, 2019, and a source for additional information on the application.

The undersigned certifies that he has made a bona fide effort to determine the addresses of the parties to be notified under Section 17-13-0107 of the Chicago Zoning Ordinance, and that the accompanying list of names and addresses of surrounding property owners within 250 feet of the subject site is a complete list containing the names and addresses of the people required to be served.

Very truly yours,

DLA Piper LLP (US)

Richard Klawiter

Subscribed and sworn to before me
This 6th day of March, 2019.

Emily Libs
Notary Public

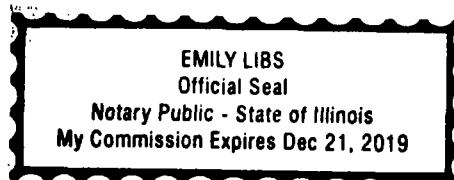

THE UNIVERSITY OF CHICAGO
LIBRARY
1100 EAST 58TH STREET
CHICAGO, ILLINOIS 60637
TEL: 773-936-3000
WWW.CHICAGO.EDU



DLA Piper LLP (US)
444 W. Lake Street Suite 900
Chicago, Illinois 60606
www.dlapiper.com

Richard Klawiter
Richard.klawiter@dlapiper.com
T 312.368.7243

March 6, 2019

FIRST CLASS MAIL

Dear Sir or Madam:

As required by Section 17-13-0107 of the Municipal Code of the City of Chicago, please be informed that on or about March 6, 2019, the undersigned, on behalf of 345 N. Morgan, LLC (the "Applicant"), intends to file an application to rezone the property located at 1000 W. Carroll / 311 and 345 N. Morgan, Chicago, Illinois, (the "Property") from the M2-3 Light Industry District and Planned Development Number 1282 to the DX-5 Mixed-Use District then to a Business Planned Development. A map of the Property is printed on the reverse side of this letter.

The Property is currently utilized for surface parking and commercial uses. The application requests a rezoning of the Property from the M2-3 Light Industry District and Planned Development Number 1282 to the DX-5 Mixed-Use District then to a Business Planned Development, in order to permit the construction of one 18-story commercial building and one 11-story commercial building containing an overall FAR of 8.1, approximately 211 overall] parking spaces, and accessory and incidental uses.

Please note that the Applicant is not seeking to rezone or purchase your property. You are receiving this notice as required by the Chicago Municipal Code because the assessor's tax records indicate that you own property within 250 feet of the Property.

I am an authorized representative of the Applicant and my address is 444 W. Lake Street, Suite 900, Chicago, IL 60606. The Applicant is the owner of the property located at 345 North Morgan and the owner of the property located at 311 North Morgan is 311 N. Morgan, LLC. Their address is 1330 West Fulton, Suite 800, Chicago, IL 60607. Carpenter Carroll, LLC owns the property located at 1000 West Carroll and its address is 1000 W. Carroll Avenue, Chicago, Illinois 60607.

Please contact me at 312-368-7423 with questions or to obtain additional information.

Very truly yours,

DLA Piper LLP (US)

A handwritten signature in black ink, appearing to read 'Richard Klawiter', written over the printed name.

Richard Klawiter

MAP

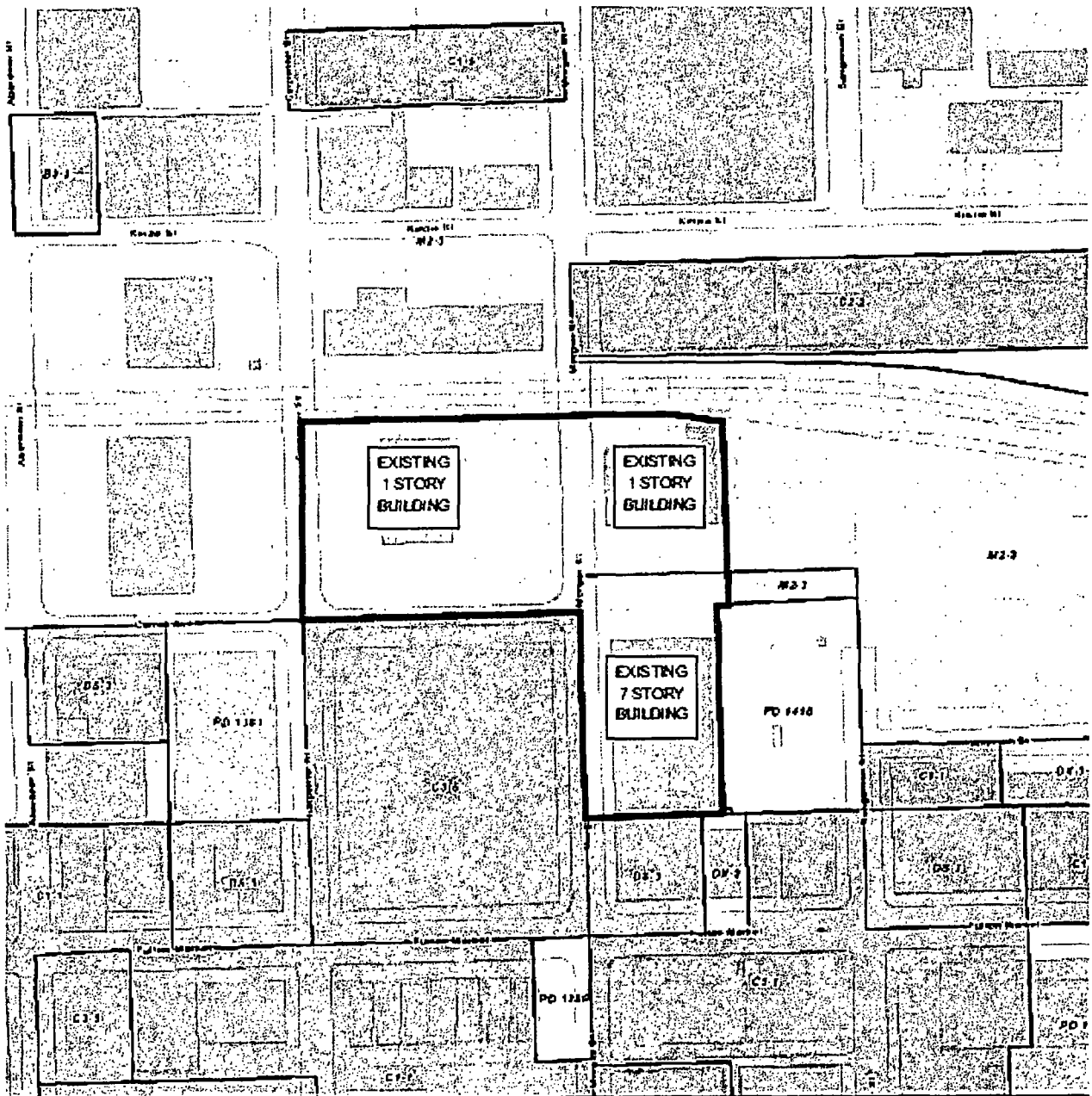

PINS

17-08-403-006-0000; 17-08-404-008-0000; 17-08-412-014-0000

Appendix A

The Applicant owns the property located at 345 North Morgan.

311 N. Morgan, LLC owns the property located at 311 North Morgan.

Address: 1330 West Fulton, Suite 800, Chicago, Illinois 60607

Contact Person: Fred Krol

Phone number: 312-202-3482

Carpenter Carroll, LLC owns the property located at 1000 West Carroll.

Address: 1000 W. Carroll Avenue, Chicago, Illinois 60607

Contact Person: Anna Simpson

Phone number: 312-466-4100

Exhibit A
311 N. MORGAN ORGANIZATIONAL CHART
 "Property Owner"

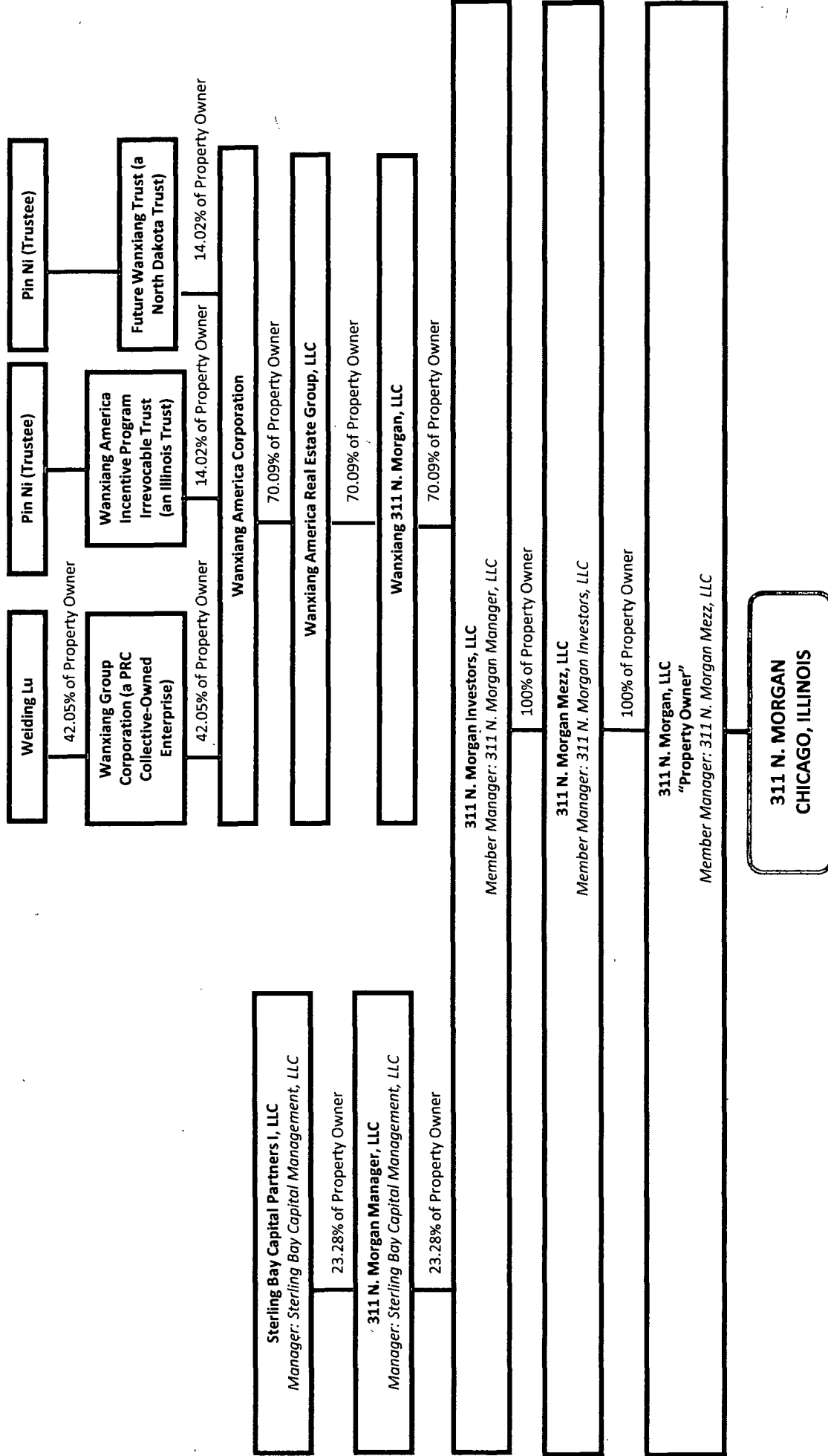

*All entities in blue have a business address of 1330.W. Fulton Street, Suite 800, Chicago, IL 60607; Wanxiang America Real Estate Group, LLC has a business address of 150 N. Riverside Plaza, Suite 1810, Chicago, IL 60606; Wanxiang 311 N. Morgan, LLC and Wanxiang America Corporation each have a business address of 88 Airport Rd., Elgin, IL 60123; Wanxiang Group Corporation, Wanxiang America Incentive Program Irrevocable Trust, and Future Wanxiang Trust each have a business address of Xiaoshan Economic and Technological Development Zone, Hanzhou, Zhejiang Province, The People's Republic of China

AUTHORIZATION

The undersigned, 311 N. Morgan, LLC, a Delaware limited liability company, being the owner of real property located generally at 311 N. Morgan Street in Chicago, Illinois (the "**Subject Property**"), hereby authorizes 345 N. Morgan, LLC, a Delaware limited liability company, and any affiliate or designee thereof and its attorneys, DLA Piper LLP (US), to file one or more applications for zoning approvals and related permits and approvals with the City of Chicago relating to the Subject Property.

26th **IN WITNESS WHEREOF**, the undersigned has executed this Authorization as of this day of February, 2019.

311 N. MORGAN, LLC, a Delaware limited liability company

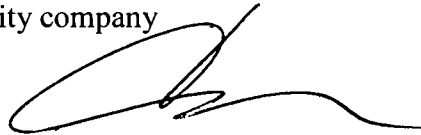

By: _____
Name: Andrew Gloor
Its: Authorized Signatory

#19980
INTRO DATE
MARCH 13, 2019

CITY OF CHICAGO

APPLICATION FOR AN AMENDMENT TO
THE CHICAGO ZONING ORDINANCE

1. ADDRESS of the property Applicant is seeking to rezone:
1000 West Carroll / 311 and 345 North Morgan, Chicago, IL

2. Ward Number that property is located in: 27th Ward

3. APPLICANT 345 N. Morgan, LLC

ADDRESS 1330 West Fulton, Suite 800

CITY Chicago STATE IL ZIP CODE 60607

PHONE 312-202-3482 EMAIL fkrol@sterlingbay.com CONTACT PERSON Fred Krol

Is the applicant the owner of the property? YES X NO X

If the applicant is not the owner of the property, please provide the following information regarding the owner and attach written authorization from the owner allowing the applicant to proceed.

OWNER See Appendix A

ADDRESS _____

CITY _____ STATE _____ ZIP CODE _____

PHONE _____ EMAIL _____ CONTACT PERSON _____

4. If the Applicant/Owner of the property has obtained a lawyer as their representative for the rezoning, please provide the following information:

ATTORNEY Rich Klawiter & Katie Jahnke Dale - DLA Piper LLP (US)

ADDRESS 444 West Lake Street, Suite 900

CITY Chicago STATE IL ZIP CODE 60606

PHONE (312) 368-7243 / -2153 FAX (312) 251-2856

EMAIL richard.klawiter@dlapiper.com / katie.dale@dlapiper.com

5. If the applicant is a legal entity (Corporation, LLC, Partnership, etc.) please provide the names of all owners as disclosed on the Economic Disclosure Statements:

See attached Economic Disclosure Statements

6. On what date did the owner acquire legal title to the subject property? 2013/2014

7. Has the present owner previously rezoned this property? If yes, when? Partially; June 2015

8. Present Zoning District M2-3 Light Industry District / PD 1282

Proposed Zoning District DX-5 Downtown Mixed-Use District then to a Business Planned Development

9. Lot size in square feet (or dimensions) +/- 105,924 square feet

10. Current Use of the Property Commercial / Surface Parking

11. Reason for rezoning the property Mandatory Planned Development pursuant to Sections 17-8-0514 (Bonus Floor Area) and 17-8-0512 (Tall Buildings)

12. Describe the proposed use of the property after the rezoning. Indicate the number of dwelling units; number of parking spaces; approximate square footage of any commercial space; and height of the proposed building. (BE SPECIFIC)

The Applicant requests a rezoning of the subject property from the M2-3 Light Industry District and Planned Development Number 1282 to the DX-5 Mixed-Use District then to a Business Planned Development to permit the construction of one 18-story commercial building and one 11-story commercial building containing an overall FAR of 8.1, approximately 211 overall parking spaces, and accessory and incidental uses.

13. The Affordable Requirements Ordinance (ARO) that requires on-site affordable housing units and/or a financial contribution for residential housing projects with ten or more units that receive a zoning change which, among other triggers, increases the allowable floor area, or, for existing Planned Developments, increases the number of units (see attached fact sheet or visit www.cityofchicago.org/ARO for more information). Is this project subject to the ARO?

YES _____ NO X

COUNTY OF COOK
STATE OF ILLINOIS

Andrew Gbor, authorized signatory of **345 N. MORGAN, LLC**, being first duly sworn on oath, states that all of the above statements and the statements contained in the documents submitted herewith are true and correct.

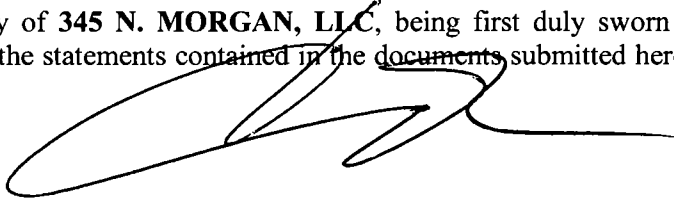

Signature of Applicant

Subscribed and Sworn to before me this
4th day of March, 2019.



Notary Public

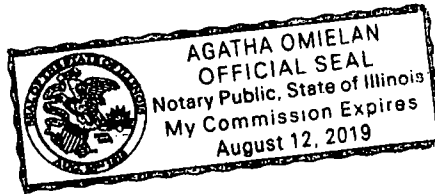

For Office Use Only

Date of Introduction: _____

File Number: _____

Ward: _____



**CITY OF CHICAGO
ECONOMIC DISCLOSURE STATEMENT
AND AFFIDAVIT**

SECTION I -- GENERAL INFORMATION

A. Legal name of the Disclosing Party submitting this EDS. Include d/b/a/ if applicable:

311 N. MORGAN, LLC

Check ONE of the following three boxes:

Indicate whether the Disclosing Party submitting this EDS is:

1. the ~~Applicant~~ Property Owner
OR

2. a legal entity currently holding, or anticipated to hold within six months after City action on the contract, transaction or other undertaking to which this EDS pertains (referred to below as the "Matter"), a direct or indirect interest in excess of 7.5% in the ~~Applicant~~. State the ~~Applicant's~~ legal name: Property Owner Property Owner's

OR

Property Owner

3. a legal entity with a direct or indirect right of control of the ~~Applicant~~ (see Section II(B)(1))
State the legal name of the entity in which the Disclosing Party holds a right of control:

B. Business address of the Disclosing Party: 1330 W. FULTON ST., SUITE 800
CHICAGO, IL 60607

C. Telephone: 312-466-4142 Fax: 312-874-7008 Email: asimpson@sterlingbay.com

D. Name of contact person: Anna Simpson

E. Federal Employer Identification No. (if you have one): _____

F. Brief description of the Matter to which this EDS pertains. (Include project number and location of property, if applicable):
Application for planned development for property located at 345 N. Morgan St., 311 N. Morgan St., and 1000 W. Carroll, Chicago, IL

G. Which City agency or department is requesting this EDS? DPD

If the Matter is a contract being handled by the City's Department of Procurement Services, please complete the following:

Specification # N/A and Contract # N/A

SECTION II -- DISCLOSURE OF OWNERSHIP INTERESTS

A. NATURE OF THE DISCLOSING PARTY

1. Indicate the nature of the Disclosing Party:

- Person
- Limited liability company
- Publicly registered business corporation
- Limited liability partnership
- Privately held business corporation
- Joint venture
- Sole proprietorship
- Not-for-profit corporation
- General partnership
- (Is the not-for-profit corporation also a 501(c)(3))?
- Limited partnership
- Yes No
- Trust
- Other (please specify)

2. For legal entities, the state (or foreign country) of incorporation or organization, if applicable:

DELAWARE

3. For legal entities not organized in the State of Illinois: Has the organization registered to do business in the State of Illinois as a foreign entity?

- Yes
- No
- Organized in Illinois

B. IF THE DISCLOSING PARTY IS A LEGAL ENTITY:

1. List below the full names and titles, if applicable, of: (i) all executive officers and all directors of the entity; (ii) **for not-for-profit corporations**, all members, if any, which are legal entities (if there are no such members, write "no members which are legal entities"); (iii) **for trusts, estates or other similar entities**, the trustee, executor, administrator, or similarly situated party; (iv) **for general or limited partnerships, limited liability companies, limited liability partnerships or joint ventures**, each general partner, managing member, manager or any other person or legal entity that directly or indirectly controls the day-to-day management of the ~~Applicant~~ ^{Property Owner}.

NOTE: Each legal entity listed below must submit an EDS on its own behalf.

Name	Title
<u>Please see attached Schedule A</u>	

2. Please provide the following information concerning each person or legal entity having a direct or indirect, current or prospective (i.e. within 6 months after City action) beneficial interest (including ownership) in excess of 7.5% of the ~~Applicant~~ ^{Property Owner}. Examples of such an interest include shares in a corporation, partnership interest in a partnership or joint venture, interest of a member or manager in a

Schedule A

311 N. Morgan Mezz, LLC- Managing Member of Property Owner

311 N. Morgan Investors, LLC- Managing Member of 311 N. Morgan Mezz, LLC

311 N. Morgan Manager, LLC- Managing Member of 311 N. Morgan Investors, LLC

Sterling Bay Capital Management, LLC- Manager of 311 N. Morgan Manager, LLC

Andrew Gloor- Sole Manager of Sterling Bay Capital Management, LLC

limited liability company, or interest of a beneficiary of a trust, estate or other similar entity. If none, state "None."

NOTE: Each legal entity listed below may be required to submit an EDS on its own behalf.

Name	Business Address	Property Owner Percentage Interest in the APPROX
Please see attached Exhibit A		

SECTION III -- INCOME OR COMPENSATION TO, OR OWNERSHIP BY, CITY ELECTED OFFICIALS

Has the Disclosing Party provided any income or compensation to any City elected official during the 12-month period preceding the date of this EDS? [] Yes [X] No

Does the Disclosing Party reasonably expect to provide any income or compensation to any City elected official during the 12-month period following the date of this EDS? [] Yes [X] No

If "yes" to either of the above, please identify below the name(s) of such City elected official(s) and describe such income or compensation:

Does any City elected official or, to the best of the Disclosing Party's knowledge after reasonable inquiry, any City elected official's spouse or domestic partner, have a financial interest (as defined in Chapter 2-156 of the Municipal Code of Chicago ("MCC")) in the Disclosing Party?

[] Yes [X] No

If "yes," please identify below the name(s) of such City elected official(s) and/or spouse(s)/domestic partner(s) and describe the financial interest(s).

SECTION IV -- DISCLOSURE OF SUBCONTRACTORS AND OTHER RETAINED PARTIES

The Disclosing Party must disclose the name and business address of each subcontractor, attorney, lobbyist (as defined in MCC Chapter 2-156), accountant, consultant and any other person or entity whom the Disclosing Party has retained or expects to retain in connection with the Matter, as well as the nature of the relationship, and the total amount of the fees paid or estimated to be paid. The Disclosing Party is not required to disclose employees who are paid solely through the Disclosing Party's regular payroll. If the Disclosing Party is uncertain whether a disclosure is required under this Section, the Disclosing Party must either ask the City whether disclosure is required or make the disclosure.

Name (indicate whether retained or anticipated to be retained)	Business Address	Relationship to Disclosing Party (subcontractor, attorney, lobbyist, etc.)	Fees (<u>indicate whether paid or estimated.</u>) NOTE: "hourly rate" or "t.b.d." is not an acceptable response.
--	------------------	--	---

(Add sheets if necessary)

Check here if the Disclosing Party has not retained, nor expects to retain, any such persons or entities.

SECTION V -- CERTIFICATIONS

A. COURT-ORDERED CHILD SUPPORT COMPLIANCE

Under MCC Section 2-92-415, substantial owners of business entities that contract with the City must remain in compliance with their child support obligations throughout the contract's term.

Has any person who directly or indirectly owns 10% or more of the Disclosing Party been declared in arrearage on any child support obligations by any Illinois court of competent jurisdiction?

Yes No No person directly or indirectly owns 10% or more of the Disclosing Party.

If "Yes," has the person entered into a court-approved agreement for payment of all support owed and is the person in compliance with that agreement?

Yes No

B. FURTHER CERTIFICATIONS

1. [This paragraph 1 applies only if the Matter is a contract being handled by the City's Department of Procurement Services.] In the 5-year period preceding the date of this EDS, neither the Disclosing Party nor any Affiliated Entity [see definition in (5) below] has engaged, in connection with the performance of any public contract, the services of an integrity monitor, independent private sector inspector general, or integrity compliance consultant (i.e., an individual or entity with legal, auditing, investigative, or other similar skills, designated by a public agency to help the agency monitor the activity of specified agency vendors as well as help the vendors reform their business practices so they can be considered for agency contracts in the future, or continue with a contract in progress).

2. The Disclosing Party and its Affiliated Entities are not delinquent in the payment of any fine, fee, tax or other source of indebtedness owed to the City of Chicago, including, but not limited to, water and sewer charges, license fees, parking tickets, property taxes and sales taxes, nor is the Disclosing Party delinquent in the payment of any tax administered by the Illinois Department of Revenue.

3. The Disclosing Party and, if the Disclosing Party is a legal entity, all of those persons or entities identified in Section II(B)(1) of this EDS:

- a. are not presently debarred, suspended, proposed for debarment, declared ineligible or voluntarily excluded from any transactions by any federal, state or local unit of government;
- b. have not, during the 5 years before the date of this EDS, been convicted of a criminal offense, adjudged guilty, or had a civil judgment rendered against them in connection with: obtaining, attempting to obtain, or performing a public (federal, state or local) transaction or contract under a public transaction; a violation of federal or state antitrust statutes; fraud; embezzlement; theft; forgery; bribery; falsification or destruction of records; making false statements; or receiving stolen property;
- c. are not presently indicted for, or criminally or civilly charged by, a governmental entity (federal, state or local) with committing any of the offenses set forth in subparagraph (b) above;
- d. have not, during the 5 years before the date of this EDS, had one or more public transactions (federal, state or local) terminated for cause or default; and
- e. have not, during the 5 years before the date of this EDS, been convicted, adjudged guilty, or found liable in a civil proceeding, or in any criminal or civil action, including actions concerning environmental violations, instituted by the City or by the federal government, any state, or any other unit of local government.

4. The Disclosing Party understands and shall comply with the applicable requirements of MCC Chapters 2-56 (Inspector General) and 2-156 (Governmental Ethics).

5. Certifications (5), (6) and (7) concern:

- the Disclosing Party;
- any "Contractor" (meaning any contractor or subcontractor used by the Disclosing Party in connection with the Matter, including but not limited to all persons or legal entities disclosed under Section IV, "Disclosure of Subcontractors and Other Retained Parties");
- any "Affiliated Entity" (meaning a person or entity that, directly or indirectly: controls the Disclosing Party, is controlled by the Disclosing Party, or is, with the Disclosing Party, under common control of another person or entity). Indicia of control include, without limitation: interlocking management or ownership; identity of interests among family members, shared facilities and equipment; common use of employees; or organization of a business entity following the ineligibility of a business entity to do business with federal or state or local government, including the City, using substantially the same management, ownership, or principals as the ineligible entity. With respect to Contractors, the term Affiliated Entity means a person or entity that directly or indirectly controls the Contractor, is controlled by it, or, with the Contractor, is under common control of another person or entity;
- any responsible official of the Disclosing Party, any Contractor or any Affiliated Entity or any other official, agent or employee of the Disclosing Party, any Contractor or any Affiliated Entity, acting pursuant to the direction or authorization of a responsible official of the Disclosing Party, any Contractor or any Affiliated Entity (collectively "Agents").

Neither the Disclosing Party, nor any Contractor, nor any Affiliated Entity of either the Disclosing Party or any Contractor, nor any Agents have, during the 5 years before the date of this EDS, or, with respect to a Contractor, an Affiliated Entity, or an Affiliated Entity of a Contractor during the 5 years before the date of such Contractor's or Affiliated Entity's contract or engagement in connection with the Matter:

- a. bribed or attempted to bribe, or been convicted or adjudged guilty of bribery or attempting to bribe, a public officer or employee of the City, the State of Illinois, or any agency of the federal government or of any state or local government in the United States of America, in that officer's or employee's official capacity;
- b. agreed or colluded with other bidders or prospective bidders, or been a party to any such agreement, or been convicted or adjudged guilty of agreement or collusion among bidders or prospective bidders, in restraint of freedom of competition by agreement to bid a fixed price or otherwise; or
- c. made an admission of such conduct described in subparagraph (a) or (b) above that is a matter of record, but have not been prosecuted for such conduct; or
- d. violated the provisions referenced in MCC Subsection 2-92-320(a)(4)(Contracts Requiring a Base Wage); (a)(5)(Debarment Regulations); or (a)(6)(Minimum Wage Ordinance).

6. Neither the Disclosing Party, nor any Affiliated Entity or Contractor, or any of their employees, officials, agents or partners, is barred from contracting with any unit of state or local government as a result of engaging in or being convicted of (1) bid-rigging in violation of 720 ILCS 5/33E-3; (2) bid-rotating in violation of 720 ILCS 5/33E-4; or (3) any similar offense of any state or of the United States of America that contains the same elements as the offense of bid-rigging or bid-rotating.

7. Neither the Disclosing Party nor any Affiliated Entity is listed on a Sanctions List maintained by the United States Department of Commerce, State, or Treasury, or any successor federal agency.

8. [FOR ~~APPLICANT~~ ONLY] (i) Neither the ~~Applicant~~ nor any "controlling person" [see MCC Chapter 1-23, Article I for applicability and defined terms] of the ~~Applicant~~ is currently indicted or charged with, or has admitted guilt of, or has ever been convicted of, or placed under supervision for, any criminal offense involving actual, attempted, or conspiracy to commit bribery, theft, fraud, forgery, perjury, dishonesty or deceit against an officer or employee of the City or any "sister agency"; and (ii) the ~~Applicant~~ understands and acknowledges that compliance with Article I is a continuing requirement for doing business with the City. NOTE: If MCC Chapter 1-23, Article I applies to the ~~Applicant~~, that Article's permanent compliance timeframe supersedes 5-year compliance timeframes in this Section V.

9. [FOR ~~APPLICANT~~ ONLY] The ~~Applicant~~ and its Affiliated Entities will not use, nor permit their subcontractors to use, any facility listed as having an active exclusion by the U.S. EPA on the federal System for Award Management ("SAM").

10. [FOR ~~APPLICANT~~ ONLY] The ~~Applicant~~ will obtain from any contractors/subcontractors hired or to be hired in connection with the Matter certifications equal in form and substance to those in Certifications (2) and (9) above and will not, without the prior written consent of the City, use any such

contractor/subcontractor that does not provide such certifications or that the ~~Applicant~~ ^{Property Owner} has reason to believe has not provided or cannot provide truthful certifications.

11. If the Disclosing Party is unable to certify to any of the above statements in this Part B (Further Certifications), the Disclosing Party must explain below:
N/A

If the letters "NA," the word "None," or no response appears on the lines above, it will be conclusively presumed that the Disclosing Party certified to the above statements.

12. To the best of the Disclosing Party's knowledge after reasonable inquiry, the following is a complete list of all current employees of the Disclosing Party who were, at any time during the 12-month period preceding the date of this EDS, an employee, or elected or appointed official, of the City of Chicago (if none, indicate with "N/A" or "none").
N/A

13. To the best of the Disclosing Party's knowledge after reasonable inquiry, the following is a complete list of all gifts that the Disclosing Party has given or caused to be given, at any time during the 12-month period preceding the execution date of this EDS, to an employee, or elected or appointed official, of the City of Chicago. For purposes of this statement, a "gift" does not include: (i) anything made generally available to City employees or to the general public, or (ii) food or drink provided in the course of official City business and having a retail value of less than \$25 per recipient, or (iii) a political contribution otherwise duly reported as required by law (if none, indicate with "N/A" or "none"). As to any gift listed below, please also list the name of the City recipient.
N/A

C. CERTIFICATION OF STATUS AS FINANCIAL INSTITUTION

1. The Disclosing Party certifies that the Disclosing Party (check one)
[] is [X] is not

a "financial institution" as defined in MCC Section 2-32-455(b).

2. If the Disclosing Party IS a financial institution, then the Disclosing Party pledges:

"We are not and will not become a predatory lender as defined in MCC Chapter 2-32. We further pledge that none of our affiliates is, and none of them will become, a predatory lender as defined in MCC Chapter 2-32. We understand that becoming a predatory lender or becoming an affiliate of a predatory lender may result in the loss of the privilege of doing business with the City."

E. CERTIFICATION REGARDING SLAVERY ERA BUSINESS

Please check either (1) or (2) below. If the Disclosing Party checks (2), the Disclosing Party must disclose below or in an attachment to this EDS all information required by (2). Failure to comply with these disclosure requirements may make any contract entered into with the City in connection with the Matter voidable by the City.

X 1. The Disclosing Party verifies that the Disclosing Party has searched any and all records of the Disclosing Party and any and all predecessor entities regarding records of investments or profits from slavery or slaveholder insurance policies during the slavery era (including insurance policies issued to slaveholders that provided coverage for damage to or injury or death of their slaves), and the Disclosing Party has found no such records.

2. The Disclosing Party verifies that, as a result of conducting the search in step (1) above, the Disclosing Party has found records of investments or profits from slavery or slaveholder insurance policies. The Disclosing Party verifies that the following constitutes full disclosure of all such records, including the names of any and all slaves or slaveholders described in those records:

SECTION VI -- CERTIFICATIONS FOR FEDERALLY FUNDED MATTERS

NOTE: If the Matter is federally funded, complete this Section VI. If the Matter is not federally funded, proceed to Section VII. For purposes of this Section VI, tax credits allocated by the City and proceeds of debt obligations of the City are not federal funding.

A. CERTIFICATION REGARDING LOBBYING

1. List below the names of all persons or entities registered under the federal Lobbying Disclosure Act of 1995, as amended, who have made lobbying contacts on behalf of the Disclosing Party with respect to the Matter: (Add sheets if necessary):

(If no explanation appears or begins on the lines above, or if the letters "NA" or if the word "None" appear, it will be conclusively presumed that the Disclosing Party means that NO persons or entities registered under the Lobbying Disclosure Act of 1995, as amended, have made lobbying contacts on behalf of the Disclosing Party with respect to the Matter.)

2. The Disclosing Party has not spent and will not expend any federally appropriated funds to pay any person or entity listed in paragraph A(1) above for his or her lobbying activities or to pay any person or entity to influence or attempt to influence an officer or employee of any agency, as defined by applicable federal law, a member of Congress, an officer or employee of Congress, or an employee

of a member of Congress, in connection with the award of any federally funded contract, making any federally funded grant or loan, entering into any cooperative agreement, or to extend, continue, renew, amend, or modify any federally funded contract, grant, loan, or cooperative agreement.

3. The Disclosing Party will submit an updated certification at the end of each calendar quarter in which there occurs any event that materially affects the accuracy of the statements and information set forth in paragraphs A(1) and A(2) above.

4. The Disclosing Party certifies that either: (i) it is not an organization described in section 501(c)(4) of the Internal Revenue Code of 1986; or (ii) it is an organization described in section 501(c)(4) of the Internal Revenue Code of 1986 but has not engaged and will not engage in "Lobbying Activities," as that term is defined in the Lobbying Disclosure Act of 1995, as amended.

Property Owner

5. If the Disclosing Party is the ~~Applicant~~, the Disclosing Party must obtain certifications equal in form and substance to paragraphs A(1) through A(4) above from all subcontractors before it awards any subcontract and the Disclosing Party must maintain all such subcontractors' certifications for the duration of the Matter and must make such certifications promptly available to the City upon request.

B. CERTIFICATION REGARDING EQUAL EMPLOYMENT OPPORTUNITY

Property Owner

If the Matter is federally funded, federal regulations require the ~~Applicant~~ and all proposed subcontractors to submit the following information with their bids or in writing at the outset of negotiations.

Property Owner

Is the Disclosing Party the ~~Applicant~~?

Yes

No

If "Yes," answer the three questions below:

1. Have you developed and do you have on file affirmative action programs pursuant to applicable federal regulations? (See 41 CFR Part 60-2.)

Yes

No

2. Have you filed with the Joint Reporting Committee, the Director of the Office of Federal Contract Compliance Programs, or the Equal Employment Opportunity Commission all reports due under the applicable filing requirements?

Yes

No

Reports not required

3. Have you participated in any previous contracts or subcontracts subject to the equal opportunity clause?

Yes

No

If you checked "No" to question (1) or (2) above, please provide an explanation:

SECTION VII -- FURTHER ACKNOWLEDGMENTS AND CERTIFICATION

The Disclosing Party understands and agrees that:

A. The certifications, disclosures, and acknowledgments contained in this EDS will become part of any contract or other agreement between the ~~Applicant~~ ^{Property Owner} and the City in connection with the Matter, whether procurement, City assistance, or other City action, and are material inducements to the City's execution of any contract or taking other action with respect to the Matter. The Disclosing Party understands that it must comply with all statutes, ordinances, and regulations on which this EDS is based.

B. The City's Governmental Ethics Ordinance, MCC Chapter 2-156, imposes certain duties and obligations on persons or entities seeking City contracts, work, business, or transactions. The full text of this ordinance and a training program is available on line at www.cityofchicago.org/Ethics, and may also be obtained from the City's Board of Ethics, 740 N. Sedgwick St., Suite 500, Chicago, IL 60610, (312) 744-9660. The Disclosing Party must comply fully with this ordinance.

C. If the City determines that any information provided in this EDS is false, incomplete or inaccurate, any contract or other agreement in connection with which it is submitted may be rescinded or be void or voidable, and the City may pursue any remedies under the contract or agreement (if not rescinded or void), at law, or in equity, including terminating the Disclosing Party's participation in the Matter and/or declining to allow the Disclosing Party to participate in other City transactions. Remedies at law for a false statement of material fact may include incarceration and an award to the City of treble damages.

D. It is the City's policy to make this document available to the public on its Internet site and/or upon request. Some or all of the information provided in, and appended to, this EDS may be made publicly available on the Internet, in response to a Freedom of Information Act request, or otherwise. By completing and signing this EDS, the Disclosing Party waives and releases any possible rights or claims which it may have against the City in connection with the public release of information contained in this EDS and also authorizes the City to verify the accuracy of any information submitted in this EDS.

E. The information provided in this EDS must be kept current. In the event of changes, the Disclosing Party must supplement this EDS up to the time the City takes action on the Matter. If the Matter is a contract being handled by the City's Department of Procurement Services, the Disclosing Party must update this EDS as the contract requires. **NOTE:** With respect to Matters subject to MCC Chapter 1-23, Article I (imposing **PERMANENT INELIGIBILITY** for certain specified offenses), the information provided herein regarding eligibility must be kept current for a longer period, as required by MCC Chapter 1-23 and Section 2-154-020.

CERTIFICATION

Under penalty of perjury, the person signing below: (1) warrants that he/she is authorized to execute this EDS, and all applicable Appendices, on behalf of the Disclosing Party, and (2) warrants that all certifications and statements contained in this EDS, and all applicable Appendices, are true, accurate and complete as of the date furnished to the City.

311 N. MORGAN, LLC
(Print or type exact legal name of Disclosing Party)

By: _____
(Sign here)

ANDREW GLOOR
(Print or type name of person signing)

Sole Manager of Sterling Bay Capital Management, LLC, manager of 311 N. Morgan Manager, LLC, managing member of 311 N. Morgan Investors, LLC, sole member of 311 N. Morgan Mezz, LLC, sole member of 311 N. Morgan, LLC

(Print or type title of person signing)

Signed and sworn to before me on (date) 2/26/19,

at COOK County, ILLINOIS (state).

[Signature]
Notary Public



Commission expires: 2/2/22

RECEIVED
FEDERAL BUREAU OF INVESTIGATION
U. S. DEPARTMENT OF JUSTICE
WASHINGTON, D. C. 20535

**CITY OF CHICAGO
ECONOMIC DISCLOSURE STATEMENT AND AFFIDAVIT
APPENDIX A**

**FAMILIAL RELATIONSHIPS WITH ELECTED CITY OFFICIALS
AND DEPARTMENT HEADS**

Property Owner

This Appendix is to be completed only by (a) the Applicant, and (b) any legal entity which has a direct ownership interest in the Applicant exceeding 7.5%. It is not to be completed by any legal entity which has only an indirect ownership interest in the Applicant.

Property Owner

Under MCC Section 2-154-015, the Disclosing Party must disclose whether such Disclosing Party or any "Applicable Party" or any Spouse or Domestic Partner thereof currently has a "familial relationship" with any elected city official or department head. A "familial relationship" exists if, as of the date this EDS is signed, the Disclosing Party or any "Applicable Party" or any Spouse or Domestic Partner thereof is related to the mayor, any alderman, the city clerk, the city treasurer or any city department head as spouse or domestic partner or as any of the following, whether by blood or adoption: parent, child, brother or sister, aunt or uncle, niece or nephew, grandparent, grandchild, father-in-law, mother-in-law, son-in-law, daughter-in-law, stepfather or stepmother, stepson or stepdaughter, stepbrother or stepsister or half-brother or half-sister.

"Applicable Party" means (1) all executive officers of the Disclosing Party listed in Section II.B.1.a., if the Disclosing Party is a corporation; all partners of the Disclosing Party, if the Disclosing Party is a general partnership; all general partners and limited partners of the Disclosing Party, if the Disclosing Party is a limited partnership; all managers, managing members and members of the Disclosing Party, if the Disclosing Party is a limited liability company; (2) all principal officers of the Disclosing Party; and (3) any person having more than a 7.5% ownership interest in the Disclosing Party. "Principal officers" means the president, chief operating officer, executive director, chief financial officer, treasurer or secretary of a legal entity or any person exercising similar authority.

Does the Disclosing Party or any "Applicable Party" or any Spouse or Domestic Partner thereof currently have a "familial relationship" with an elected city official or department head?

Yes No

If yes, please identify below (1) the name and title of such person, (2) the name of the legal entity to which such person is connected; (3) the name and title of the elected city official or department head to whom such person has a familial relationship, and (4) the precise nature of such familial relationship.

**CITY OF CHICAGO
ECONOMIC DISCLOSURE STATEMENT AND AFFIDAVIT
APPENDIX B**

BUILDING CODE SCOFFLAW/PROBLEM LANDLORD CERTIFICATION

This Appendix is to be completed only by (a) the ^{Property Owner} ~~Applicant~~, and (b) any legal entity which has a direct ownership interest in the ^{Property Owner} ~~Applicant~~ exceeding 7.5% (an "Owner"). It is not to be completed by any legal entity which has only an indirect ownership interest in the ^{Property Owner} ~~Applicant~~. ^{Property Owner}

1. Pursuant to MCC Section 2-154-010, is the ^{Property Owner} ~~Applicant~~ or any Owner identified as a building code scofflaw or problem landlord pursuant to MCC Section 2-92-416?

Yes No

2. If the ^{Property Owner} ~~Applicant~~ is a legal entity publicly traded on any exchange, is any officer or director of the ^{Property Owner} ~~Applicant~~ identified as a building code scofflaw or problem landlord pursuant to MCC Section 2-92-416?

Yes No ^{Property Owner} The ~~Applicant~~ is not publicly traded on any exchange.

3. If yes to (1) or (2) above, please identify below the name of each person or legal entity identified as a building code scofflaw or problem landlord and the address of each building or buildings to which the pertinent code violations apply.

**CITY OF CHICAGO
ECONOMIC DISCLOSURE STATEMENT AND AFFIDAVIT
APPENDIX C**

PROHIBITION ON WAGE & SALARY HISTORY SCREENING - CERTIFICATION

This Appendix is to be completed only by an ^{Property Owner}~~Applicant~~ that is completing this EDS as a “contractor” as defined in MCC Section 2-92-385. That section, which should be consulted (www.amlegal.com), generally covers a party to any agreement pursuant to which they: (i) receive City of Chicago funds in consideration for services, work or goods provided (including for legal or other professional services), or (ii) pay the City money for a license, grant or concession allowing them to conduct a business on City premises.

On behalf of an ^{Property Owner}~~Applicant~~ that is a contractor pursuant to MCC Section 2-92-385, I hereby certify that the ~~Applicant~~ ^{Property Owner} is in compliance with MCC Section 2-92-385(b)(1) and (2), which prohibit: (i) screening job applicants based on their wage or salary history, or (ii) seeking job applicants’ wage or salary history from current or former employers. I also certify that the ~~Applicant~~ ^{Property Owner} has adopted a policy that includes those prohibitions.

Yes

No

N/A – I am not an ^{Property Owner}~~Applicant~~ that is a “contractor” as defined in MCC Section 2-92-385.

This certification shall serve as the affidavit required by MCC Section 2-92-385(c)(1).

If you checked “no” to the above, please explain.

**CITY OF CHICAGO
ECONOMIC DISCLOSURE STATEMENT
AND AFFIDAVIT**

SECTION I -- GENERAL INFORMATION

A. Legal name of the Disclosing Party submitting this EDS. Include d/b/a/ if applicable:

311 N. MORGAN MEZZ, LLC

Check ONE of the following three boxes:

Indicate whether the Disclosing Party submitting this EDS is:

1. the ~~Applicant~~ Property Owner

OR

2. a legal entity currently holding, or anticipated to hold within six months after City action on the contract, transaction or other undertaking to which this EDS pertains (referred to below as the "Matter"), a direct or indirect interest in excess of 7.5% in the ~~Applicant~~. State the ~~Applicant's~~ legal name: 311 N. MORGAN, LLC ~~Property Owner~~ ~~Property Owner's~~

OR

Property Owner

3. a legal entity with a direct or indirect right of control of the ~~Applicant~~ (see Section II(B)(1)) State the legal name of the entity in which the Disclosing Party holds a right of control:

B. Business address of the Disclosing Party: 1330 W. FULTON ST., SUITE 800
CHICAGO, IL 60607

C. Telephone: 312-466-4142 Fax: 312-874-7008 Email: asimpson@sterlingbay.com

D. Name of contact person: Anna Simpson

E. Federal Employer Identification No. (if you have one): _____

F. Brief description of the Matter to which this EDS pertains. (Include project number and location of property, if applicable):

Application for Planned Development for property commonly known as 345 N. Morgan St., 311 N. Morgan St., and 1000 W. Carroll Ave., Chicago, IL

G. Which City agency or department is requesting this EDS? DPD

If the Matter is a contract being handled by the City's Department of Procurement Services, please complete the following:

Specification # N/A and Contract # N/A

SECTION II -- DISCLOSURE OF OWNERSHIP INTERESTS

A. NATURE OF THE DISCLOSING PARTY

1. Indicate the nature of the Disclosing Party:

- Person
 - Publicly registered business corporation
 - Privately held business corporation
 - Sole proprietorship
 - General partnership
 - Limited partnership
 - Trust
 - Limited liability company
 - Limited liability partnership
 - Joint venture
 - Not-for-profit corporation
- (Is the not-for-profit corporation also a 501(c)(3))?
 Yes No
 Other (please specify)

2. For legal entities, the state (or foreign country) of incorporation or organization, if applicable:

Delaware

3. For legal entities not organized in the State of Illinois: Has the organization registered to do business in the State of Illinois as a foreign entity?

- Yes
- No
- Organized in Illinois

B. IF THE DISCLOSING PARTY IS A LEGAL ENTITY:

1. List below the full names and titles, if applicable, of: (i) all executive officers and all directors of the entity; (ii) **for not-for-profit corporations**, all members, if any, which are legal entities (if there are no such members, write "no members which are legal entities"); (iii) **for trusts, estates or other similar entities**, the trustee, executor, administrator, or similarly situated party; (iv) **for general or limited partnerships, limited liability companies, limited liability partnerships or joint ventures**, each general partner, managing member, manager or any other person or legal entity that directly or indirectly controls the day-to-day management of the ~~Applicant~~ **Property Owner**

NOTE: Each legal entity listed below must submit an EDS on its own behalf.

Name	Title
Please refer to Property Owner EDS	

2. Please provide the following information concerning each person or legal entity having a direct or indirect, current or prospective (i.e. within 6 months after City action) beneficial interest (including ownership) in excess of 7.5% of the ~~Applicant~~ **Property Owner**. Examples of such an interest include shares in a corporation, partnership interest in a partnership or joint venture, interest of a member or manager in a

limited liability company, or interest of a beneficiary of a trust, estate or other similar entity. If none, state "None."

NOTE: Each legal entity listed below may be required to submit an EDS on its own behalf.

		Property Owner
Name	Business Address	Percentage Interest in the APPRAISAL
Please see attached Exhibit A		

SECTION III -- INCOME OR COMPENSATION TO, OR OWNERSHIP BY, CITY ELECTED OFFICIALS

Has the Disclosing Party provided any income or compensation to any City elected official during the 12-month period preceding the date of this EDS? [] Yes [X] No

Does the Disclosing Party reasonably expect to provide any income or compensation to any City elected official during the 12-month period following the date of this EDS? [] Yes [X] No

If "yes" to either of the above, please identify below the name(s) of such City elected official(s) and describe such income or compensation:

Does any City elected official or, to the best of the Disclosing Party's knowledge after reasonable inquiry, any City elected official's spouse or domestic partner, have a financial interest (as defined in Chapter 2-156 of the Municipal Code of Chicago ("MCC")) in the Disclosing Party?

[] Yes [X] No

If "yes," please identify below the name(s) of such City elected official(s) and/or spouse(s)/domestic partner(s) and describe the financial interest(s).

SECTION IV -- DISCLOSURE OF SUBCONTRACTORS AND OTHER RETAINED PARTIES

The Disclosing Party must disclose the name and business address of each subcontractor, attorney, lobbyist (as defined in MCC Chapter 2-156), accountant, consultant and any other person or entity whom the Disclosing Party has retained or expects to retain in connection with the Matter, as well as the nature of the relationship, and the total amount of the fees paid or estimated to be paid. The Disclosing Party is not required to disclose employees who are paid solely through the Disclosing Party's regular payroll. If the Disclosing Party is uncertain whether a disclosure is required under this Section, the Disclosing Party must either ask the City whether disclosure is required or make the disclosure.

Exhibit A
311 N. MORGAN ORGANIZATIONAL CHART
 "Property Owner"

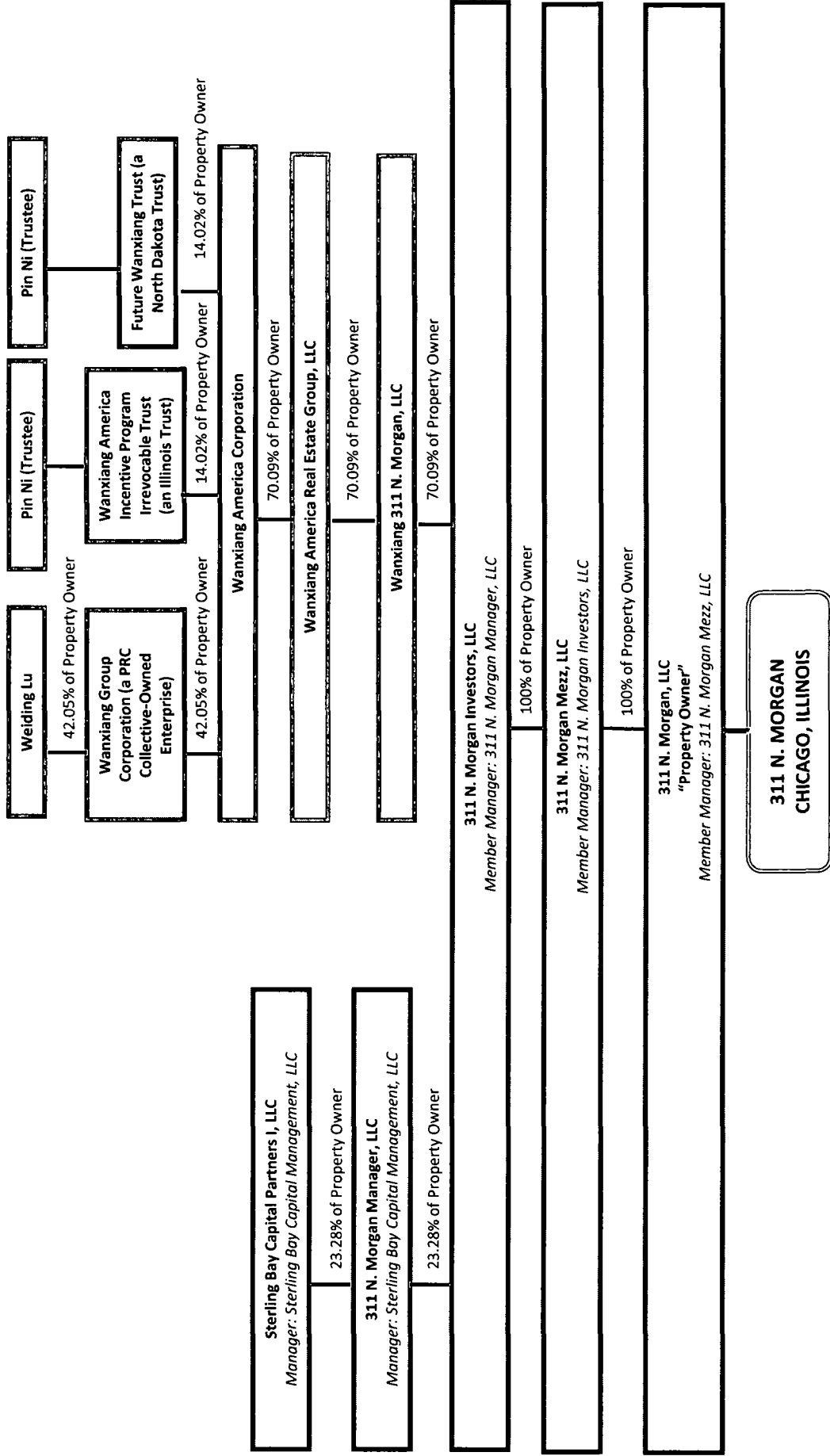

* All entities in blue have a business address of 1330 W. Fulton Street, Suite 800, Chicago, IL 60607; Wanxiang America Real Estate Group, LLC has a business address of 150 N. Riverside Plaza, Suite 1810, Chicago, IL 60606; Wanxiang 311 N. Morgan, LLC and Wanxiang America Corporation each have a business address of 88 Airport Rd., Elgin, IL 60123; Wanxiang Group Corporation, Wanxiang America Incentive Program Irrevocable Trust, and Future Wanxiang Trust each have a business address of Xiaoshan Economic and Technological Development Zone, Hanzhou, Zhejiang Province, The People's Republic of China

Name (indicate whether retained or anticipated to be retained)	Business Address	Relationship to Disclosing Party (subcontractor, attorney, lobbyist, etc.)	Fees (indicate whether paid or estimated.) NOTE: "hourly rate" or "t.b.d." is not an acceptable response.
--	------------------	--	--

(Add sheets if necessary)

Check here if the Disclosing Party has not retained, nor expects to retain, any such persons or entities.

SECTION V -- CERTIFICATIONS

A. COURT-ORDERED CHILD SUPPORT COMPLIANCE

Under MCC Section 2-92-415, substantial owners of business entities that contract with the City must remain in compliance with their child support obligations throughout the contract's term.

Has any person who directly or indirectly owns 10% or more of the Disclosing Party been declared in arrearage on any child support obligations by any Illinois court of competent jurisdiction?

Yes No No person directly or indirectly owns 10% or more of the Disclosing Party.

If "Yes," has the person entered into a court-approved agreement for payment of all support owed and is the person in compliance with that agreement?

Yes No

B. FURTHER CERTIFICATIONS

1. [This paragraph 1 applies only if the Matter is a contract being handled by the City's Department of Procurement Services.] In the 5-year period preceding the date of this EDS, neither the Disclosing Party nor any Affiliated Entity [see definition in (5) below] has engaged, in connection with the performance of any public contract, the services of an integrity monitor, independent private sector inspector general, or integrity compliance consultant (i.e., an individual or entity with legal, auditing, investigative, or other similar skills, designated by a public agency to help the agency monitor the activity of specified agency vendors as well as help the vendors reform their business practices so they can be considered for agency contracts in the future, or continue with a contract in progress).

2. The Disclosing Party and its Affiliated Entities are not delinquent in the payment of any fine, fee, tax or other source of indebtedness owed to the City of Chicago, including, but not limited to, water and sewer charges, license fees, parking tickets, property taxes and sales taxes, nor is the Disclosing Party delinquent in the payment of any tax administered by the Illinois Department of Revenue.

3. The Disclosing Party and, if the Disclosing Party is a legal entity, all of those persons or entities identified in Section II(B)(1) of this EDS:

- a. are not presently debarred, suspended, proposed for debarment, declared ineligible or voluntarily excluded from any transactions by any federal, state or local unit of government;
- b. have not, during the 5 years before the date of this EDS, been convicted of a criminal offense, adjudged guilty, or had a civil judgment rendered against them in connection with: obtaining, attempting to obtain, or performing a public (federal, state or local) transaction or contract under a public transaction; a violation of federal or state antitrust statutes; fraud; embezzlement; theft; forgery; bribery; falsification or destruction of records; making false statements; or receiving stolen property;
- c. are not presently indicted for, or criminally or civilly charged by, a governmental entity (federal, state or local) with committing any of the offenses set forth in subparagraph (b) above;
- d. have not, during the 5 years before the date of this EDS, had one or more public transactions (federal, state or local) terminated for cause or default; and
- e. have not, during the 5 years before the date of this EDS, been convicted, adjudged guilty, or found liable in a civil proceeding, or in any criminal or civil action, including actions concerning environmental violations, instituted by the City or by the federal government, any state, or any other unit of local government.

4. The Disclosing Party understands and shall comply with the applicable requirements of MCC Chapters 2-56 (Inspector General) and 2-156 (Governmental Ethics).

5. Certifications (5), (6) and (7) concern:

- the Disclosing Party;
- any "Contractor" (meaning any contractor or subcontractor used by the Disclosing Party in connection with the Matter, including but not limited to all persons or legal entities disclosed under Section IV, "Disclosure of Subcontractors and Other Retained Parties");
- any "Affiliated Entity" (meaning a person or entity that, directly or indirectly: controls the Disclosing Party, is controlled by the Disclosing Party, or is, with the Disclosing Party, under common control of another person or entity). Indicia of control include, without limitation: interlocking management or ownership; identity of interests among family members, shared facilities and equipment; common use of employees; or organization of a business entity following the ineligibility of a business entity to do business with federal or state or local government, including the City, using substantially the same management, ownership, or principals as the ineligible entity. With respect to Contractors, the term Affiliated Entity means a person or entity that directly or indirectly controls the Contractor, is controlled by it, or, with the Contractor, is under common control of another person or entity;
- any responsible official of the Disclosing Party, any Contractor or any Affiliated Entity or any other official, agent or employee of the Disclosing Party, any Contractor or any Affiliated Entity, acting pursuant to the direction or authorization of a responsible official of the Disclosing Party, any Contractor or any Affiliated Entity (collectively "Agents").

contractor/subcontractor that does not provide such certifications or that the ~~Applicant~~ **Property Owner** has reason to believe has not provided or cannot provide truthful certifications.

11. If the Disclosing Party is unable to certify to any of the above statements in this Part B (Further Certifications), the Disclosing Party must explain below:

N/A

If the letters "NA," the word "None," or no response appears on the lines above, it will be conclusively presumed that the Disclosing Party certified to the above statements.

12. To the best of the Disclosing Party's knowledge after reasonable inquiry, the following is a complete list of all current employees of the Disclosing Party who were, at any time during the 12-month period preceding the date of this EDS, an employee, or elected or appointed official, of the City of Chicago (if none, indicate with "N/A" or "none").

N/A

13. To the best of the Disclosing Party's knowledge after reasonable inquiry, the following is a complete list of all gifts that the Disclosing Party has given or caused to be given, at any time during the 12-month period preceding the execution date of this EDS, to an employee, or elected or appointed official, of the City of Chicago. For purposes of this statement, a "gift" does not include: (i) anything made generally available to City employees or to the general public, or (ii) food or drink provided in the course of official City business and having a retail value of less than \$25 per recipient, or (iii) a political contribution otherwise duly reported as required by law (if none, indicate with "N/A" or "none"). As to any gift listed below, please also list the name of the City recipient.

N/A

C. CERTIFICATION OF STATUS AS FINANCIAL INSTITUTION

1. The Disclosing Party certifies that the Disclosing Party (check one)
[] is [X] is not

a "financial institution" as defined in MCC Section 2-32-455(b).

2. If the Disclosing Party IS a financial institution, then the Disclosing Party pledges:

"We are not and will not become a predatory lender as defined in MCC Chapter 2-32. We further pledge that none of our affiliates is, and none of them will become, a predatory lender as defined in MCC Chapter 2-32. We understand that becoming a predatory lender or becoming an affiliate of a predatory lender may result in the loss of the privilege of doing business with the City."

If the Disclosing Party is unable to make this pledge because it or any of its affiliates (as defined in MCC Section 2-32-455(b)) is a predatory lender within the meaning of MCC Chapter 2-32, explain here (attach additional pages if necessary):

N/A

If the letters "NA," the word "None," or no response appears on the lines above, it will be conclusively presumed that the Disclosing Party certified to the above statements.

D. CERTIFICATION REGARDING FINANCIAL INTEREST IN CITY BUSINESS

Any words or terms defined in MCC Chapter 2-156 have the same meanings if used in this Part D.

1. In accordance with MCC Section 2-156-110: To the best of the Disclosing Party's knowledge after reasonable inquiry, does any official or employee of the City have a financial interest in his or her own name or in the name of any other person or entity in the Matter?

Yes

No

NOTE: If you checked "Yes" to Item D(1), proceed to Items D(2) and D(3). If you checked "No" to Item D(1), skip Items D(2) and D(3) and proceed to Part E.

2. Unless sold pursuant to a process of competitive bidding, or otherwise permitted, no City elected official or employee shall have a financial interest in his or her own name or in the name of any other person or entity in the purchase of any property that (i) belongs to the City, or (ii) is sold for taxes or assessments, or (iii) is sold by virtue of legal process at the suit of the City (collectively, "City Property Sale"). Compensation for property taken pursuant to the City's eminent domain power does not constitute a financial interest within the meaning of this Part D.

Does the Matter involve a City Property Sale?

Yes

No

3. If you checked "Yes" to Item D(1), provide the names and business addresses of the City officials or employees having such financial interest and identify the nature of the financial interest:

Name	Business Address	Nature of Financial Interest
<hr/>		
<hr/>		
<hr/>		

4. The Disclosing Party further certifies that no prohibited financial interest in the Matter will be acquired by any City official or employee.

E. CERTIFICATION REGARDING SLAVERY ERA BUSINESS

Please check either (1) or (2) below. If the Disclosing Party checks (2), the Disclosing Party must disclose below or in an attachment to this EDS all information required by (2). Failure to comply with these disclosure requirements may make any contract entered into with the City in connection with the Matter voidable by the City.

X 1. The Disclosing Party verifies that the Disclosing Party has searched any and all records of the Disclosing Party and any and all predecessor entities regarding records of investments or profits from slavery or slaveholder insurance policies during the slavery era (including insurance policies issued to slaveholders that provided coverage for damage to or injury or death of their slaves), and the Disclosing Party has found no such records.

___ 2. The Disclosing Party verifies that, as a result of conducting the search in step (1) above, the Disclosing Party has found records of investments or profits from slavery or slaveholder insurance policies. The Disclosing Party verifies that the following constitutes full disclosure of all such records, including the names of any and all slaves or slaveholders described in those records:

SECTION VI -- CERTIFICATIONS FOR FEDERALLY FUNDED MATTERS

NOTE: If the Matter is federally funded, complete this Section VI. **If the Matter is not federally funded**, proceed to Section VII. For purposes of this Section VI, tax credits allocated by the City and proceeds of debt obligations of the City are not federal funding.

A. CERTIFICATION REGARDING LOBBYING

1. List below the names of all persons or entities registered under the federal Lobbying Disclosure Act of 1995, as amended, who have made lobbying contacts on behalf of the Disclosing Party with respect to the Matter: (Add sheets if necessary):

(If no explanation appears or begins on the lines above, or if the letters "NA" or if the word "None" appear, it will be conclusively presumed that the Disclosing Party means that NO persons or entities registered under the Lobbying Disclosure Act of 1995, as amended, have made lobbying contacts on behalf of the Disclosing Party with respect to the Matter.)

2. The Disclosing Party has not spent and will not expend any federally appropriated funds to pay any person or entity listed in paragraph A(1) above for his or her lobbying activities or to pay any person or entity to influence or attempt to influence an officer or employee of any agency, as defined by applicable federal law, a member of Congress, an officer or employee of Congress, or an employee

of a member of Congress, in connection with the award of any federally funded contract, making any federally funded grant or loan, entering into any cooperative agreement, or to extend, continue, renew, amend, or modify any federally funded contract, grant, loan, or cooperative agreement.

3. The Disclosing Party will submit an updated certification at the end of each calendar quarter in which there occurs any event that materially affects the accuracy of the statements and information set forth in paragraphs A(1) and A(2) above.

4. The Disclosing Party certifies that either: (i) it is not an organization described in section 501(c)(4) of the Internal Revenue Code of 1986; or (ii) it is an organization described in section 501(c)(4) of the Internal Revenue Code of 1986 but has not engaged and will not engage in "Lobbying Activities," as that term is defined in the Lobbying Disclosure Act of 1995, as amended.

5. If the Disclosing Party is the ~~Applicant~~ ^{Property Owner}, the Disclosing Party must obtain certifications equal in form and substance to paragraphs A(1) through A(4) above from all subcontractors before it awards any subcontract and the Disclosing Party must maintain all such subcontractors' certifications for the duration of the Matter and must make such certifications promptly available to the City upon request.

B. CERTIFICATION REGARDING EQUAL EMPLOYMENT OPPORTUNITY

If the Matter is federally funded, federal regulations require the ~~Applicant~~ ^{Property Owner} and all proposed subcontractors to submit the following information with their bids or in writing at the outset of negotiations.

Is the Disclosing Party the ~~Applicant~~ ^{Property Owner}?
 Yes No

If "Yes," answer the three questions below:

1. Have you developed and do you have on file affirmative action programs pursuant to applicable federal regulations? (See 41 CFR Part 60-2.)
 Yes No

2. Have you filed with the Joint Reporting Committee, the Director of the Office of Federal Contract Compliance Programs, or the Equal Employment Opportunity Commission all reports due under the applicable filing requirements?
 Yes No Reports not required

3. Have you participated in any previous contracts or subcontracts subject to the equal opportunity clause?
 Yes No

If you checked "No" to question (1) or (2) above, please provide an explanation:

SECTION VII -- FURTHER ACKNOWLEDGMENTS AND CERTIFICATION

The Disclosing Party understands and agrees that:

A. The certifications, disclosures, and acknowledgments contained in this EDS will become part of any contract or other agreement between the ~~Applicant~~ ^{Property Owner} and the City in connection with the Matter, whether procurement, City assistance, or other City action, and are material inducements to the City's execution of any contract or taking other action with respect to the Matter. The Disclosing Party understands that it must comply with all statutes, ordinances, and regulations on which this EDS is based.

B. The City's Governmental Ethics Ordinance, MCC Chapter 2-156, imposes certain duties and obligations on persons or entities seeking City contracts, work, business, or transactions. The full text of this ordinance and a training program is available on line at www.cityofchicago.org/Ethics, and may also be obtained from the City's Board of Ethics, 740 N. Sedgwick St., Suite 500, Chicago, IL 60610, (312) 744-9660. The Disclosing Party must comply fully with this ordinance.

C. If the City determines that any information provided in this EDS is false, incomplete or inaccurate, any contract or other agreement in connection with which it is submitted may be rescinded or be void or voidable, and the City may pursue any remedies under the contract or agreement (if not rescinded or void), at law, or in equity, including terminating the Disclosing Party's participation in the Matter and/or declining to allow the Disclosing Party to participate in other City transactions. Remedies at law for a false statement of material fact may include incarceration and an award to the City of treble damages.

D. It is the City's policy to make this document available to the public on its Internet site and/or upon request. Some or all of the information provided in, and appended to, this EDS may be made publicly available on the Internet, in response to a Freedom of Information Act request, or otherwise. By completing and signing this EDS, the Disclosing Party waives and releases any possible rights or claims which it may have against the City in connection with the public release of information contained in this EDS and also authorizes the City to verify the accuracy of any information submitted in this EDS.

E. The information provided in this EDS must be kept current. In the event of changes, the Disclosing Party must supplement this EDS up to the time the City takes action on the Matter. If the Matter is a contract being handled by the City's Department of Procurement Services, the Disclosing Party must update this EDS as the contract requires. **NOTE:** With respect to Matters subject to MCC Chapter 1-23, Article I (imposing **PERMANENT INELIGIBILITY** for certain specified offenses), the information provided herein regarding eligibility must be kept current for a longer period, as required by MCC Chapter 1-23 and Section 2-154-020.

CERTIFICATION

Under penalty of perjury, the person signing below: (1) warrants that he/she is authorized to execute this EDS, and all applicable Appendices, on behalf of the Disclosing Party, and (2) warrants that all certifications and statements contained in this EDS, and all applicable Appendices, are true, accurate and complete as of the date furnished to the City.

311 N. MORGAN MEZZ, LLC

(Print or type exact legal name of Disclosing Party)

By: _____

(Sign here)

ANDREW GLOOR

(Print or type name of person signing)

Sole manager of Sterling Bay Capital Management, LLC, manager of 311 N. Morgan Manager, LLC, managing member of
(Print or type title of person signing) 311 N. Morgan Investors, LLC, sole member of 311 N. Morgan Mezz, LLC

Signed and sworn to before me on (date) 2/26/19,

at Cook County, Illinois (state).

Notary Public

Commission expires: 2/2/22

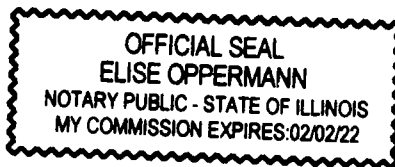

NOTARY PUBLIC - STATE OF ILLINOIS
ELISE OPPERMAN
OFFICIAL SEAL
MY COMMISSION EXPIRES 03/31/24

**CITY OF CHICAGO
ECONOMIC DISCLOSURE STATEMENT AND AFFIDAVIT
APPENDIX A**

**FAMILIAL RELATIONSHIPS WITH ELECTED CITY OFFICIALS
AND DEPARTMENT HEADS**

Property Owner

This Appendix is to be completed only by (a) the Applicant, and (b) any legal entity which has a direct ownership interest in the Applicant exceeding 7.5%. It is not to be completed by any legal entity which has only an indirect ownership interest in the Applicant.

Property Owner

Under MCC Section 2-154-015, the Disclosing Party must disclose whether such Disclosing Party or any "Applicable Party" or any Spouse or Domestic Partner thereof currently has a "familial relationship" with any elected city official or department head. A "familial relationship" exists if, as of the date this EDS is signed, the Disclosing Party or any "Applicable Party" or any Spouse or Domestic Partner thereof is related to the mayor, any alderman, the city clerk, the city treasurer or any city department head as spouse or domestic partner or as any of the following, whether by blood or adoption: parent, child, brother or sister, aunt or uncle, niece or nephew, grandparent, grandchild, father-in-law, mother-in-law, son-in-law, daughter-in-law, stepfather or stepmother, stepson or stepdaughter, stepbrother or stepsister or half-brother or half-sister.

"Applicable Party" means (1) all executive officers of the Disclosing Party listed in Section II.B.1.a., if the Disclosing Party is a corporation; all partners of the Disclosing Party, if the Disclosing Party is a general partnership; all general partners and limited partners of the Disclosing Party, if the Disclosing Party is a limited partnership; all managers, managing members and members of the Disclosing Party, if the Disclosing Party is a limited liability company; (2) all principal officers of the Disclosing Party; and (3) any person having more than a 7.5% ownership interest in the Disclosing Party. "Principal officers" means the president, chief operating officer, executive director, chief financial officer, treasurer or secretary of a legal entity or any person exercising similar authority.

Does the Disclosing Party or any "Applicable Party" or any Spouse or Domestic Partner thereof currently have a "familial relationship" with an elected city official or department head?

Yes No

If yes, please identify below (1) the name and title of such person, (2) the name of the legal entity to which such person is connected; (3) the name and title of the elected city official or department head to whom such person has a familial relationship, and (4) the precise nature of such familial relationship.

**CITY OF CHICAGO
ECONOMIC DISCLOSURE STATEMENT AND AFFIDAVIT
APPENDIX B**

BUILDING CODE SCOFFLAW/PROBLEM LANDLORD CERTIFICATION

This Appendix is to be completed only by (a) the ^{Property Owner} ~~Applicant~~, and (b) any legal entity which has a direct ownership interest in the ~~Applicant~~ ^{Property Owner} exceeding 7.5% (an "Owner"). It is not to be completed by any legal entity which has only an indirect ownership interest in the ~~Applicant~~ ^{Property Owner}.

1. Pursuant to MCC Section 2-154-010, is the ^{Property Owner} ~~Applicant~~ or any Owner identified as a building code scofflaw or problem landlord pursuant to MCC Section 2-92-416?

Yes No

2. If the ^{Property Owner} ~~Applicant~~ is a legal entity publicly traded on any exchange, is any officer or director of the ~~Applicant~~ ^{Property Owner} identified as a building code scofflaw or problem landlord pursuant to MCC Section 2-92-416?

Yes No The ^{Property Owner} ~~Applicant~~ is not publicly traded on any exchange.

3. If yes to (1) or (2) above, please identify below the name of each person or legal entity identified as a building code scofflaw or problem landlord and the address of each building or buildings to which the pertinent code violations apply.

**CITY OF CHICAGO
ECONOMIC DISCLOSURE STATEMENT AND AFFIDAVIT
APPENDIX C**

PROHIBITION ON WAGE & SALARY HISTORY SCREENING - CERTIFICATION

This Appendix is to be completed only by an ^{Property Owner}~~Applicant~~ that is completing this EDS as a “contractor” as defined in MCC Section 2-92-385. That section, which should be consulted (www.amlegal.com), generally covers a party to any agreement pursuant to which they: (i) receive City of Chicago funds in consideration for services, work or goods provided (including for legal or other professional services), or (ii) pay the City money for a license, grant or concession allowing them to conduct a business on City premises.

On behalf of an ^{Property Owner}~~Applicant~~ that is a contractor pursuant to MCC Section 2-92-385, I hereby certify that the ^{Property Owner}~~Applicant~~ is in compliance with MCC Section 2-92-385(b)(1) and (2), which prohibit: (i) screening job applicants based on their wage or salary history, or (ii) seeking job applicants’ wage or salary history from current or former employers. I also certify that the ^{Property Owner}~~Applicant~~ has adopted a policy that includes those prohibitions.

Yes

No

N/A – I am not an ^{Property Owner}~~Applicant~~ that is a “contractor” as defined in MCC Section 2-92-385.

This certification shall serve as the affidavit required by MCC Section 2-92-385(c)(1).

If you checked “no” to the above, please explain.

**CITY OF CHICAGO
ECONOMIC DISCLOSURE STATEMENT
AND AFFIDAVIT**

SECTION I -- GENERAL INFORMATION

A. Legal name of the Disclosing Party submitting this EDS. Include d/b/a/ if applicable:

311 N. MORGAN INVESTORS, LLC

Check ONE of the following three boxes:

Indicate whether the Disclosing Party submitting this EDS is:

1. the ~~Applicant~~ Property Owner
OR

2. a legal entity currently holding, or anticipated to hold within six months after City action on the contract, transaction or other undertaking to which this EDS pertains (referred to below as the "Matter"), a direct or indirect interest in excess of 7.5% in the ~~Applicant~~. State the ~~Applicant's~~ legal name: 311 N. MORGAN, LLC ~~Property Owner~~ ~~Property Owner's~~
OR Property Owner

3. a legal entity with a direct or indirect right of control of the ~~Applicant~~ (see Section II(B)(1))
State the legal name of the entity in which the Disclosing Party holds a right of control:

B. Business address of the Disclosing Party: 1330 W. FULTON ST., SUITE 800
CHICAGO, IL 60607

C. Telephone: 312-466-4142 Fax: 312-874-7008 Email: asimpson@sterlingbay.com

D. Name of contact person: Anna Simpson

E. Federal Employer Identification No. (if you have one): _____

F. Brief description of the Matter to which this EDS pertains. (Include project number and location of property, if applicable):

Application for Planned Development for property commonly known as 345 N. Morgan St., 311 N. Morgan St., and 1000 W. Carroll Ave., Chicago, IL

G. Which City agency or department is requesting this EDS? DPD

If the Matter is a contract being handled by the City's Department of Procurement Services, please complete the following:

Specification # N/A and Contract # N/A

SECTION II -- DISCLOSURE OF OWNERSHIP INTERESTS

A. NATURE OF THE DISCLOSING PARTY

1. Indicate the nature of the Disclosing Party:

- Person
 - Publicly registered business corporation
 - Privately held business corporation
 - Sole proprietorship
 - General partnership
 - Limited partnership
 - Trust
 - Limited liability company
 - Limited liability partnership
 - Joint venture
 - Not-for-profit corporation
- (Is the not-for-profit corporation also a 501(c)(3))?
 Yes No
 Other (please specify)

2. For legal entities, the state (or foreign country) of incorporation or organization, if applicable:

Delaware

3. For legal entities not organized in the State of Illinois: Has the organization registered to do business in the State of Illinois as a foreign entity?

- Yes
- No
- Organized in Illinois

B. IF THE DISCLOSING PARTY IS A LEGAL ENTITY:

1. List below the full names and titles, if applicable, of: (i) all executive officers and all directors of the entity; (ii) **for not-for-profit corporations**, all members, if any, which are legal entities (if there are no such members, write "no members which are legal entities"); (iii) **for trusts, estates or other similar entities**, the trustee, executor, administrator, or similarly situated party; (iv) **for general or limited partnerships, limited liability companies, limited liability partnerships or joint ventures**, each general partner, managing member, manager or any other person or legal entity that directly or indirectly controls the day-to-day management of the ~~Applicant~~. Property Owner

NOTE: Each legal entity listed below must submit an EDS on its own behalf.

Name	Title
Please refer to Property Owner EDS	

2. Please provide the following information concerning each person or legal entity having a direct or indirect, current or prospective (i.e. within 6 months after City action) beneficial interest (including ownership) in excess of 7.5% of the ~~Applicant~~. Examples of such an interest include shares in a corporation, partnership interest in a partnership or joint venture, interest of a member or manager in a

limited liability company, or interest of a beneficiary of a trust, estate or other similar entity. If none, state "None."

NOTE: Each legal entity listed below may be required to submit an EDS on its own behalf.

Name	Business Address	Percentage Interest in the	Property Owner
Please see attached Exhibit A			APPLICANT

SECTION III -- INCOME OR COMPENSATION TO, OR OWNERSHIP BY, CITY ELECTED OFFICIALS

Has the Disclosing Party provided any income or compensation to any City elected official during the 12-month period preceding the date of this EDS? [] Yes [X] No

Does the Disclosing Party reasonably expect to provide any income or compensation to any City elected official during the 12-month period following the date of this EDS? [] Yes [X] No

If "yes" to either of the above, please identify below the name(s) of such City elected official(s) and describe such income or compensation:

Does any City elected official or, to the best of the Disclosing Party's knowledge after reasonable inquiry, any City elected official's spouse or domestic partner, have a financial interest (as defined in Chapter 2-156 of the Municipal Code of Chicago ("MCC")) in the Disclosing Party?

[] Yes [X] No

If "yes," please identify below the name(s) of such City elected official(s) and/or spouse(s)/domestic partner(s) and describe the financial interest(s).

SECTION IV -- DISCLOSURE OF SUBCONTRACTORS AND OTHER RETAINED PARTIES

The Disclosing Party must disclose the name and business address of each subcontractor, attorney, lobbyist (as defined in MCC Chapter 2-156), accountant, consultant and any other person or entity whom the Disclosing Party has retained or expects to retain in connection with the Matter, as well as the nature of the relationship, and the total amount of the fees paid or estimated to be paid. The Disclosing Party is not required to disclose employees who are paid solely through the Disclosing Party's regular payroll. If the Disclosing Party is uncertain whether a disclosure is required under this Section, the Disclosing Party must either ask the City whether disclosure is required or make the disclosure.

Name (indicate whether retained or anticipated to be retained)	Business Address	Relationship to Disclosing Party (subcontractor, attorney, lobbyist, etc.)	Fees (indicate whether paid or estimated.) NOTE: "hourly rate" or "t.b.d." is not an acceptable response.
--	------------------	--	--

(Add sheets if necessary)

Check here if the Disclosing Party has not retained, nor expects to retain, any such persons or entities.

SECTION V -- CERTIFICATIONS

A. COURT-ORDERED CHILD SUPPORT COMPLIANCE

Under MCC Section 2-92-415, substantial owners of business entities that contract with the City must remain in compliance with their child support obligations throughout the contract's term.

Has any person who directly or indirectly owns 10% or more of the Disclosing Party been declared in arrearage on any child support obligations by any Illinois court of competent jurisdiction?

Yes No No person directly or indirectly owns 10% or more of the Disclosing Party.

If "Yes," has the person entered into a court-approved agreement for payment of all support owed and is the person in compliance with that agreement?

Yes No

B. FURTHER CERTIFICATIONS

1. [This paragraph 1 applies only if the Matter is a contract being handled by the City's Department of Procurement Services.] In the 5-year period preceding the date of this EDS, neither the Disclosing Party nor any Affiliated Entity [see definition in (5) below] has engaged, in connection with the performance of any public contract, the services of an integrity monitor, independent private sector inspector general, or integrity compliance consultant (i.e., an individual or entity with legal, auditing, investigative, or other similar skills, designated by a public agency to help the agency monitor the activity of specified agency vendors as well as help the vendors reform their business practices so they can be considered for agency contracts in the future, or continue with a contract in progress).

2. The Disclosing Party and its Affiliated Entities are not delinquent in the payment of any fine, fee, tax or other source of indebtedness owed to the City of Chicago, including, but not limited to, water and sewer charges, license fees, parking tickets, property taxes and sales taxes, nor is the Disclosing Party delinquent in the payment of any tax administered by the Illinois Department of Revenue.

3. The Disclosing Party and, if the Disclosing Party is a legal entity, all of those persons or entities identified in Section II(B)(1) of this EDS:

- a. are not presently debarred, suspended, proposed for debarment, declared ineligible or voluntarily excluded from any transactions by any federal, state or local unit of government;
- b. have not, during the 5 years before the date of this EDS, been convicted of a criminal offense, adjudged guilty, or had a civil judgment rendered against them in connection with: obtaining, attempting to obtain, or performing a public (federal, state or local) transaction or contract under a public transaction; a violation of federal or state antitrust statutes; fraud; embezzlement; theft; forgery; bribery; falsification or destruction of records; making false statements; or receiving stolen property;
- c. are not presently indicted for, or criminally or civilly charged by, a governmental entity (federal, state or local) with committing any of the offenses set forth in subparagraph (b) above;
- d. have not, during the 5 years before the date of this EDS, had one or more public transactions (federal, state or local) terminated for cause or default; and
- e. have not, during the 5 years before the date of this EDS, been convicted, adjudged guilty, or found liable in a civil proceeding, or in any criminal or civil action, including actions concerning environmental violations, instituted by the City or by the federal government, any state, or any other unit of local government.

4. The Disclosing Party understands and shall comply with the applicable requirements of MCC Chapters 2-56 (Inspector General) and 2-156 (Governmental Ethics).

5. Certifications (5), (6) and (7) concern:

- the Disclosing Party;
- any "Contractor" (meaning any contractor or subcontractor used by the Disclosing Party in connection with the Matter, including but not limited to all persons or legal entities disclosed under Section IV, "Disclosure of Subcontractors and Other Retained Parties");
- any "Affiliated Entity" (meaning a person or entity that, directly or indirectly: controls the Disclosing Party, is controlled by the Disclosing Party, or is, with the Disclosing Party, under common control of another person or entity). Indicia of control include, without limitation: interlocking management or ownership; identity of interests among family members, shared facilities and equipment; common use of employees; or organization of a business entity following the ineligibility of a business entity to do business with federal or state or local government, including the City, using substantially the same management, ownership, or principals as the ineligible entity. With respect to Contractors, the term Affiliated Entity means a person or entity that directly or indirectly controls the Contractor, is controlled by it, or, with the Contractor, is under common control of another person or entity;
- any responsible official of the Disclosing Party, any Contractor or any Affiliated Entity or any other official, agent or employee of the Disclosing Party, any Contractor or any Affiliated Entity, acting pursuant to the direction or authorization of a responsible official of the Disclosing Party, any Contractor or any Affiliated Entity (collectively "Agents").

Neither the Disclosing Party, nor any Contractor, nor any Affiliated Entity of either the Disclosing Party or any Contractor, nor any Agents have, during the 5 years before the date of this EDS, or, with respect to a Contractor, an Affiliated Entity, or an Affiliated Entity of a Contractor during the 5 years before the date of such Contractor's or Affiliated Entity's contract or engagement in connection with the Matter:

- a. bribed or attempted to bribe, or been convicted or adjudged guilty of bribery or attempting to bribe, a public officer or employee of the City, the State of Illinois, or any agency of the federal government or of any state or local government in the United States of America, in that officer's or employee's official capacity;
- b. agreed or colluded with other bidders or prospective bidders, or been a party to any such agreement, or been convicted or adjudged guilty of agreement or collusion among bidders or prospective bidders, in restraint of freedom of competition by agreement to bid a fixed price or otherwise; or
- c. made an admission of such conduct described in subparagraph (a) or (b) above that is a matter of record, but have not been prosecuted for such conduct; or
- d. violated the provisions referenced in MCC Subsection 2-92-320(a)(4)(Contracts Requiring a Base Wage); (a)(5)(Debarment Regulations); or (a)(6)(Minimum Wage Ordinance).

6. Neither the Disclosing Party, nor any Affiliated Entity or Contractor, or any of their employees, officials, agents or partners, is barred from contracting with any unit of state or local government as a result of engaging in or being convicted of (1) bid-rigging in violation of 720 ILCS 5/33E-3; (2) bid-rotating in violation of 720 ILCS 5/33E-4; or (3) any similar offense of any state or of the United States of America that contains the same elements as the offense of bid-rigging or bid-rotating.

7. Neither the Disclosing Party nor any Affiliated Entity is listed on a Sanctions List maintained by the United States Department of Commerce, State, or Treasury, or any successor federal agency.

PROPERTY OWNER **Property Owner**
8. [FOR ~~APPLICANT~~ ONLY] (i) Neither the ~~Applicant~~ nor any "controlling person" [see MCC Chapter 1-23, Article I for applicability and defined terms] of the ~~Applicant~~ is currently indicted or charged with, or has admitted guilt of, or has ever been convicted of, or placed under supervision for, any criminal offense involving actual, attempted, or conspiracy to commit bribery, theft, fraud, forgery, perjury, dishonesty or deceit against an officer or employee of the City or any "sister agency"; and (ii) the ~~Applicant~~ understands and acknowledges that compliance with Article I is a continuing requirement for doing business with the City. NOTE: If MCC Chapter 1-23, Article I applies to the ~~Applicant~~, that Article's permanent compliance timeframe supersedes 5-year compliance timeframes in this Section V.

PROPERTY OWNER **Property Owner**
9. [FOR ~~APPLICANT~~ ONLY] The ~~Applicant~~ and its Affiliated Entities will not use, nor permit their subcontractors to use, any facility listed as having an active exclusion by the U.S. EPA on the federal System for Award Management ("SAM").

PROPERTY OWNER **Property Owner**
10. [FOR ~~APPLICANT~~ ONLY] The ~~Applicant~~ will obtain from any contractors/subcontractors hired or to be hired in connection with the Matter certifications equal in form and substance to those in Certifications (2) and (9) above and will not, without the prior written consent of the City, use any such

contractor/subcontractor that does not provide such certifications or that the ~~Applicant~~ **Property Owner** has reason to believe has not provided or cannot provide truthful certifications.

11. If the Disclosing Party is unable to certify to any of the above statements in this Part B (Further Certifications), the Disclosing Party must explain below:

N/A

If the letters "NA," the word "None," or no response appears on the lines above, it will be conclusively presumed that the Disclosing Party certified to the above statements.

12. To the best of the Disclosing Party's knowledge after reasonable inquiry, the following is a complete list of all current employees of the Disclosing Party who were, at any time during the 12-month period preceding the date of this EDS, an employee, or elected or appointed official, of the City of Chicago (if none, indicate with "N/A" or "none").

N/A

13. To the best of the Disclosing Party's knowledge after reasonable inquiry, the following is a complete list of all gifts that the Disclosing Party has given or caused to be given, at any time during the 12-month period preceding the execution date of this EDS, to an employee, or elected or appointed official, of the City of Chicago. For purposes of this statement, a "gift" does not include: (i) anything made generally available to City employees or to the general public, or (ii) food or drink provided in the course of official City business and having a retail value of less than \$25 per recipient, or (iii) a political contribution otherwise duly reported as required by law (if none, indicate with "N/A" or "none"). As to any gift listed below, please also list the name of the City recipient.

N/A

C. CERTIFICATION OF STATUS AS FINANCIAL INSTITUTION

1. The Disclosing Party certifies that the Disclosing Party (check one)

is is not

a "financial institution" as defined in MCC Section 2-32-455(b).

2. If the Disclosing Party IS a financial institution, then the Disclosing Party pledges:

"We are not and will not become a predatory lender as defined in MCC Chapter 2-32. We further pledge that none of our affiliates is, and none of them will become, a predatory lender as defined in MCC Chapter 2-32. We understand that becoming a predatory lender or becoming an affiliate of a predatory lender may result in the loss of the privilege of doing business with the City."

If the Disclosing Party is unable to make this pledge because it or any of its affiliates (as defined in MCC Section 2-32-455(b)) is a predatory lender within the meaning of MCC Chapter 2-32, explain here (attach additional pages if necessary):

N/A

If the letters "NA," the word "None," or no response appears on the lines above, it will be conclusively presumed that the Disclosing Party certified to the above statements.

D. CERTIFICATION REGARDING FINANCIAL INTEREST IN CITY BUSINESS

Any words or terms defined in MCC Chapter 2-156 have the same meanings if used in this Part D.

1. In accordance with MCC Section 2-156-110: To the best of the Disclosing Party's knowledge after reasonable inquiry, does any official or employee of the City have a financial interest in his or her own name or in the name of any other person or entity in the Matter?

Yes No

NOTE: If you checked "Yes" to Item D(1), proceed to Items D(2) and D(3). If you checked "No" to Item D(1), skip Items D(2) and D(3) and proceed to Part E.

2. Unless sold pursuant to a process of competitive bidding, or otherwise permitted, no City elected official or employee shall have a financial interest in his or her own name or in the name of any other person or entity in the purchase of any property that (i) belongs to the City, or (ii) is sold for taxes or assessments, or (iii) is sold by virtue of legal process at the suit of the City (collectively, "City Property Sale"). Compensation for property taken pursuant to the City's eminent domain power does not constitute a financial interest within the meaning of this Part D.

Does the Matter involve a City Property Sale?

Yes No

3. If you checked "Yes" to Item D(1), provide the names and business addresses of the City officials or employees having such financial interest and identify the nature of the financial interest:

Name	Business Address	Nature of Financial Interest
<hr/>		
<hr/>		
<hr/>		

4. The Disclosing Party further certifies that no prohibited financial interest in the Matter will be acquired by any City official or employee.

E. CERTIFICATION REGARDING SLAVERY ERA BUSINESS

Please check either (1) or (2) below. If the Disclosing Party checks (2), the Disclosing Party must disclose below or in an attachment to this EDS all information required by (2). Failure to comply with these disclosure requirements may make any contract entered into with the City in connection with the Matter voidable by the City.

X 1. The Disclosing Party verifies that the Disclosing Party has searched any and all records of the Disclosing Party and any and all predecessor entities regarding records of investments or profits from slavery or slaveholder insurance policies during the slavery era (including insurance policies issued to slaveholders that provided coverage for damage to or injury or death of their slaves), and the Disclosing Party has found no such records.

___ 2. The Disclosing Party verifies that, as a result of conducting the search in step (1) above, the Disclosing Party has found records of investments or profits from slavery or slaveholder insurance policies. The Disclosing Party verifies that the following constitutes full disclosure of all such records, including the names of any and all slaves or slaveholders described in those records:

SECTION VI -- CERTIFICATIONS FOR FEDERALLY FUNDED MATTERS

NOTE: If the Matter is federally funded, complete this Section VI. If the Matter is not federally funded, proceed to Section VII. For purposes of this Section VI, tax credits allocated by the City and proceeds of debt obligations of the City are not federal funding.

A. CERTIFICATION REGARDING LOBBYING

1. List below the names of all persons or entities registered under the federal Lobbying Disclosure Act of 1995, as amended, who have made lobbying contacts on behalf of the Disclosing Party with respect to the Matter: (Add sheets if necessary):

(If no explanation appears or begins on the lines above, or if the letters "NA" or if the word "None" appear, it will be conclusively presumed that the Disclosing Party means that NO persons or entities registered under the Lobbying Disclosure Act of 1995, as amended, have made lobbying contacts on behalf of the Disclosing Party with respect to the Matter.)

2. The Disclosing Party has not spent and will not expend any federally appropriated funds to pay any person or entity listed in paragraph A(1) above for his or her lobbying activities or to pay any person or entity to influence or attempt to influence an officer or employee of any agency, as defined by applicable federal law, a member of Congress, an officer or employee of Congress, or an employee

of a member of Congress, in connection with the award of any federally funded contract, making any federally funded grant or loan, entering into any cooperative agreement, or to extend, continue, renew, amend, or modify any federally funded contract, grant, loan, or cooperative agreement.

3. The Disclosing Party will submit an updated certification at the end of each calendar quarter in which there occurs any event that materially affects the accuracy of the statements and information set forth in paragraphs A(1) and A(2) above.

4. The Disclosing Party certifies that either: (i) it is not an organization described in section 501(c)(4) of the Internal Revenue Code of 1986; or (ii) it is an organization described in section 501(c)(4) of the Internal Revenue Code of 1986 but has not engaged and will not engage in "Lobbying Activities," as that term is defined in the Lobbying Disclosure Act of 1995, as amended.

5. If the Disclosing Party is the ~~Applicant~~ ^{Property Owner}, the Disclosing Party must obtain certifications equal in form and substance to paragraphs A(1) through A(4) above from all subcontractors before it awards any subcontract and the Disclosing Party must maintain all such subcontractors' certifications for the duration of the Matter and must make such certifications promptly available to the City upon request.

B. CERTIFICATION REGARDING EQUAL EMPLOYMENT OPPORTUNITY

If the Matter is federally funded, federal regulations require the ~~Applicant~~ ^{Property Owner} and all proposed subcontractors to submit the following information with their bids or in writing at the outset of negotiations.

Is the Disclosing Party the ~~Applicant~~ ^{Property Owner}?
 Yes No

If "Yes," answer the three questions below:

1. Have you developed and do you have on file affirmative action programs pursuant to applicable federal regulations? (See 41 CFR Part 60-2.)
 Yes No

2. Have you filed with the Joint Reporting Committee, the Director of the Office of Federal Contract Compliance Programs, or the Equal Employment Opportunity Commission all reports due under the applicable filing requirements?
 Yes No Reports not required

3. Have you participated in any previous contracts or subcontracts subject to the equal opportunity clause?
 Yes No

If you checked "No" to question (1) or (2) above, please provide an explanation:

SECTION VII -- FURTHER ACKNOWLEDGMENTS AND CERTIFICATION

The Disclosing Party understands and agrees that:

A. The certifications, disclosures, and acknowledgments contained in this EDS will become part of any contract or other agreement between the ~~Applicant~~ ^{Property Owner} and the City in connection with the Matter, whether procurement, City assistance, or other City action, and are material inducements to the City's execution of any contract or taking other action with respect to the Matter. The Disclosing Party understands that it must comply with all statutes, ordinances, and regulations on which this EDS is based.

B. The City's Governmental Ethics Ordinance, MCC Chapter 2-156, imposes certain duties and obligations on persons or entities seeking City contracts, work, business, or transactions. The full text of this ordinance and a training program is available on line at www.cityofchicago.org/Ethics, and may also be obtained from the City's Board of Ethics, 740 N. Sedgwick St., Suite 500, Chicago, IL 60610, (312) 744-9660. The Disclosing Party must comply fully with this ordinance.

C. If the City determines that any information provided in this EDS is false, incomplete or inaccurate, any contract or other agreement in connection with which it is submitted may be rescinded or be void or voidable, and the City may pursue any remedies under the contract or agreement (if not rescinded or void), at law, or in equity, including terminating the Disclosing Party's participation in the Matter and/or declining to allow the Disclosing Party to participate in other City transactions. Remedies at law for a false statement of material fact may include incarceration and an award to the City of treble damages.

D. It is the City's policy to make this document available to the public on its Internet site and/or upon request. Some or all of the information provided in, and appended to, this EDS may be made publicly available on the Internet, in response to a Freedom of Information Act request, or otherwise. By completing and signing this EDS, the Disclosing Party waives and releases any possible rights or claims which it may have against the City in connection with the public release of information contained in this EDS and also authorizes the City to verify the accuracy of any information submitted in this EDS.

E. The information provided in this EDS must be kept current. In the event of changes, the Disclosing Party must supplement this EDS up to the time the City takes action on the Matter. If the Matter is a contract being handled by the City's Department of Procurement Services, the Disclosing Party must update this EDS as the contract requires. **NOTE:** With respect to Matters subject to MCC Chapter 1-23, Article I (imposing **PERMANENT INELIGIBILITY** for certain specified offenses), the information provided herein regarding eligibility must be kept current for a longer period, as required by MCC Chapter 1-23 and Section 2-154-020.

CERTIFICATION

Under penalty of perjury, the person signing below: (1) warrants that he/she is authorized to execute this EDS, and all applicable Appendices, on behalf of the Disclosing Party, and (2) warrants that all certifications and statements contained in this EDS, and all applicable Appendices, are true, accurate and complete as of the date furnished to the City.

311 N. MORGAN INVESTORS, LLC
(Print or type exact legal name of Disclosing Party)

By: _____
(Sign here) .

ANDREW GLOOR
(Print or type name of person signing)

Sole manager of Sterling Bay Capital Management, LLC, manager of 311 N. Morgan Manager, LLC, managing member of
(Print or type title of person signing) 311 N. Morgan Investors, LLC

Signed and sworn to before me on (date) 2/26/19 .

at Cook County, Illinois (state).

[Signature]
Notary Public



Commission expires: 2/2/22

NOTARY PUBLIC STATE OF TEXAS
MY COMMISSION EXPIRES 08/31/2012
ELISE JOHNSON
08/31/2012

**CITY OF CHICAGO
ECONOMIC DISCLOSURE STATEMENT AND AFFIDAVIT
APPENDIX A**

**FAMILIAL RELATIONSHIPS WITH ELECTED CITY OFFICIALS
AND DEPARTMENT HEADS**

Property Owner

This Appendix is to be completed only by (a) the Applicant, and (b) any legal entity which has a direct ownership interest in the Applicant exceeding 7.5%. It is not to be completed by any legal entity which has only an indirect ownership interest in the Applicant.

Property Owner

Under MCC Section 2-154-015, the Disclosing Party must disclose whether such Disclosing Party or any "Applicable Party" or any Spouse or Domestic Partner thereof currently has a "familial relationship" with any elected city official or department head. A "familial relationship" exists if, as of the date this EDS is signed, the Disclosing Party or any "Applicable Party" or any Spouse or Domestic Partner thereof is related to the mayor, any alderman, the city clerk, the city treasurer or any city department head as spouse or domestic partner or as any of the following, whether by blood or adoption: parent, child, brother or sister, aunt or uncle, niece or nephew, grandparent, grandchild, father-in-law, mother-in-law, son-in-law, daughter-in-law, stepfather or stepmother, stepson or stepdaughter, stepbrother or stepsister or half-brother or half-sister.

"Applicable Party" means (1) all executive officers of the Disclosing Party listed in Section II.B.1.a., if the Disclosing Party is a corporation; all partners of the Disclosing Party, if the Disclosing Party is a general partnership; all general partners and limited partners of the Disclosing Party, if the Disclosing Party is a limited partnership; all managers, managing members and members of the Disclosing Party, if the Disclosing Party is a limited liability company; (2) all principal officers of the Disclosing Party; and (3) any person having more than a 7.5% ownership interest in the Disclosing Party. "Principal officers" means the president, chief operating officer, executive director, chief financial officer, treasurer or secretary of a legal entity or any person exercising similar authority.

Does the Disclosing Party or any "Applicable Party" or any Spouse or Domestic Partner thereof currently have a "familial relationship" with an elected city official or department head?

Yes No

If yes, please identify below (1) the name and title of such person, (2) the name of the legal entity to which such person is connected; (3) the name and title of the elected city official or department head to whom such person has a familial relationship, and (4) the precise nature of such familial relationship.

**CITY OF CHICAGO
ECONOMIC DISCLOSURE STATEMENT AND AFFIDAVIT
APPENDIX B**

BUILDING CODE SCOFFLAW/PROBLEM LANDLORD CERTIFICATION

This Appendix is to be completed only by (a) the ^{Property Owner} ~~Applicant~~, and (b) any legal entity which has a direct ownership interest in the ~~Applicant~~ ^{Property Owner} exceeding 7.5% (an "Owner"). It is not to be completed by any legal entity which has only an indirect ownership interest in the ~~Applicant~~ ^{Property Owner}.

1. Pursuant to MCC Section 2-154-010, is the ^{Property Owner} ~~Applicant~~ or any Owner identified as a building code scofflaw or problem landlord pursuant to MCC Section 2-92-416?

Yes No

2. If the ^{Property Owner} ~~Applicant~~ is a legal entity publicly traded on any exchange, is any officer or director of the ~~Applicant~~ ^{Property Owner} identified as a building code scofflaw or problem landlord pursuant to MCC Section 2-92-416?

Yes No The ^{Property Owner} ~~Applicant~~ is not publicly traded on any exchange.

3. If yes to (1) or (2) above, please identify below the name of each person or legal entity identified as a building code scofflaw or problem landlord and the address of each building or buildings to which the pertinent code violations apply.

**CITY OF CHICAGO
ECONOMIC DISCLOSURE STATEMENT AND AFFIDAVIT
APPENDIX C**

PROHIBITION ON WAGE & SALARY HISTORY SCREENING - CERTIFICATION

Property Owner
~~Applicant~~

This Appendix is to be completed only by an ~~Applicant~~ that is completing this EDS as a “contractor” as defined in MCC Section 2-92-385. That section, which should be consulted (www.amlegal.com), generally covers a party to any agreement pursuant to which they: (i) receive City of Chicago funds in consideration for services, work or goods provided (including for legal or other professional services), or (ii) pay the City money for a license, grant or concession allowing them to conduct a business on City premises.

Property Owner
~~Applicant~~

On behalf of an ~~Applicant~~ that is a contractor pursuant to MCC Section 2-92-385, I hereby certify that the ~~Applicant~~ is in compliance with MCC Section 2-92-385(b)(1) and (2), which prohibit: (i) screening job applicants based on their wage or salary history, or (ii) seeking job applicants’ wage or salary history from current or former employers. I also certify that the ~~Applicant~~ has adopted a policy that includes those prohibitions.

Property Owner

Yes

No

Property Owner
~~Applicant~~

N/A – I am not an ~~Applicant~~ that is a “contractor” as defined in MCC Section 2-92-385.

This certification shall serve as the affidavit required by MCC Section 2-92-385(c)(1).

If you checked “no” to the above, please explain.

**CITY OF CHICAGO
ECONOMIC DISCLOSURE STATEMENT
AND AFFIDAVIT**

SECTION I -- GENERAL INFORMATION

A. Legal name of the Disclosing Party submitting this EDS. Include d/b/a/ if applicable:

311 N. MORGAN MANAGER, LLC

Check ONE of the following three boxes:

Indicate whether the Disclosing Party submitting this EDS is:

1. the ~~Applicant~~ Property Owner
OR

2. a legal entity currently holding, or anticipated to hold within six months after City action on the contract, transaction or other undertaking to which this EDS pertains (referred to below as the "Matter"), a direct or indirect interest in excess of 7.5% in the ~~Applicant~~. State the ~~Applicant's~~ legal name: 311 N. MORGAN, LLC ~~Property Owner~~ Property Owner's

OR

Property Owner

3. a legal entity with a direct or indirect right of control of the ~~Applicant~~ (see Section II(B)(1))
State the legal name of the entity in which the Disclosing Party holds a right of control:

B. Business address of the Disclosing Party: 1330 W. FULTON ST., SUITE 800
CHICAGO, IL 60607

C. Telephone: 312-466-4142 Fax: 312-874-7008 Email: asimpson@sterlingbay.com

D. Name of contact person: Anna Simpson

E. Federal Employer Identification No. (if you have one): _____

F. Brief description of the Matter to which this EDS pertains. (Include project number and location of property, if applicable):

Application for Planned Development for property commonly known as 345 N. Morgan St., 311 N. Morgan St., and 1000 W. Carroll Ave., Chicago, IL

G. Which City agency or department is requesting this EDS? DPD

If the Matter is a contract being handled by the City's Department of Procurement Services, please complete the following:

Specification # N/A and Contract # N/A

SECTION II -- DISCLOSURE OF OWNERSHIP INTERESTS

A. NATURE OF THE DISCLOSING PARTY

1. Indicate the nature of the Disclosing Party:

- Person
- Publicly registered business corporation
- Privately held business corporation
- Sole proprietorship
- General partnership
- Limited partnership
- Trust
- Limited liability company
- Limited liability partnership
- Joint venture
- Not-for-profit corporation
(Is the not-for-profit corporation also a 501(c)(3))?
 Yes No
- Other (please specify)

2. For legal entities, the state (or foreign country) of incorporation or organization, if applicable:

Delaware

3. For legal entities not organized in the State of Illinois: Has the organization registered to do business in the State of Illinois as a foreign entity?

- Yes
- No
- Organized in Illinois

B. IF THE DISCLOSING PARTY IS A LEGAL ENTITY:

1. List below the full names and titles, if applicable, of: (i) all executive officers and all directors of the entity; (ii) **for not-for-profit corporations**, all members, if any, which are legal entities (if there are no such members, write "no members which are legal entities"); (iii) **for trusts, estates or other similar entities**, the trustee, executor, administrator, or similarly situated party; (iv) **for general or limited partnerships, limited liability companies, limited liability partnerships or joint ventures**, each general partner, managing member, manager or any other person or legal entity that directly or indirectly controls the day-to-day management of the ~~Applicant~~ ^{Property Owner}.

NOTE: Each legal entity listed below must submit an EDS on its own behalf.

Name	Title
Please refer to Property Owner EDS	

2. Please provide the following information concerning each person or legal entity having a direct or indirect, current or prospective (i.e. within 6 months after City action) beneficial interest (including ownership) in excess of 7.5% of the ~~Applicant~~ ^{Property Owner}. Examples of such an interest include shares in a corporation, partnership interest in a partnership or joint venture, interest of a member or manager in a

limited liability company, or interest of a beneficiary of a trust, estate or other similar entity. If none, state "None."

NOTE: Each legal entity listed below may be required to submit an EDS on its own behalf.

Name	Business Address	Percentage Interest in the	Property Owner
Please see attached Exhibit A			

SECTION III -- INCOME OR COMPENSATION TO, OR OWNERSHIP BY, CITY ELECTED OFFICIALS

Has the Disclosing Party provided any income or compensation to any City elected official during the 12-month period preceding the date of this EDS? [] Yes [X] No

Does the Disclosing Party reasonably expect to provide any income or compensation to any City elected official during the 12-month period following the date of this EDS? [] Yes [X] No

If "yes" to either of the above, please identify below the name(s) of such City elected official(s) and describe such income or compensation:

Does any City elected official or, to the best of the Disclosing Party's knowledge after reasonable inquiry, any City elected official's spouse or domestic partner, have a financial interest (as defined in Chapter 2-156 of the Municipal Code of Chicago ("MCC")) in the Disclosing Party?

[] Yes [X] No

If "yes," please identify below the name(s) of such City elected official(s) and/or spouse(s)/domestic partner(s) and describe the financial interest(s).

SECTION IV -- DISCLOSURE OF SUBCONTRACTORS AND OTHER RETAINED PARTIES

The Disclosing Party must disclose the name and business address of each subcontractor, attorney, lobbyist (as defined in MCC Chapter 2-156), accountant, consultant and any other person or entity whom the Disclosing Party has retained or expects to retain in connection with the Matter, as well as the nature of the relationship, and the total amount of the fees paid or estimated to be paid. The Disclosing Party is not required to disclose employees who are paid solely through the Disclosing Party's regular payroll. If the Disclosing Party is uncertain whether a disclosure is required under this Section, the Disclosing Party must either ask the City whether disclosure is required or make the disclosure.

Exhibit A
311 N. MORGAN ORGANIZATIONAL CHART
 "Property Owner"

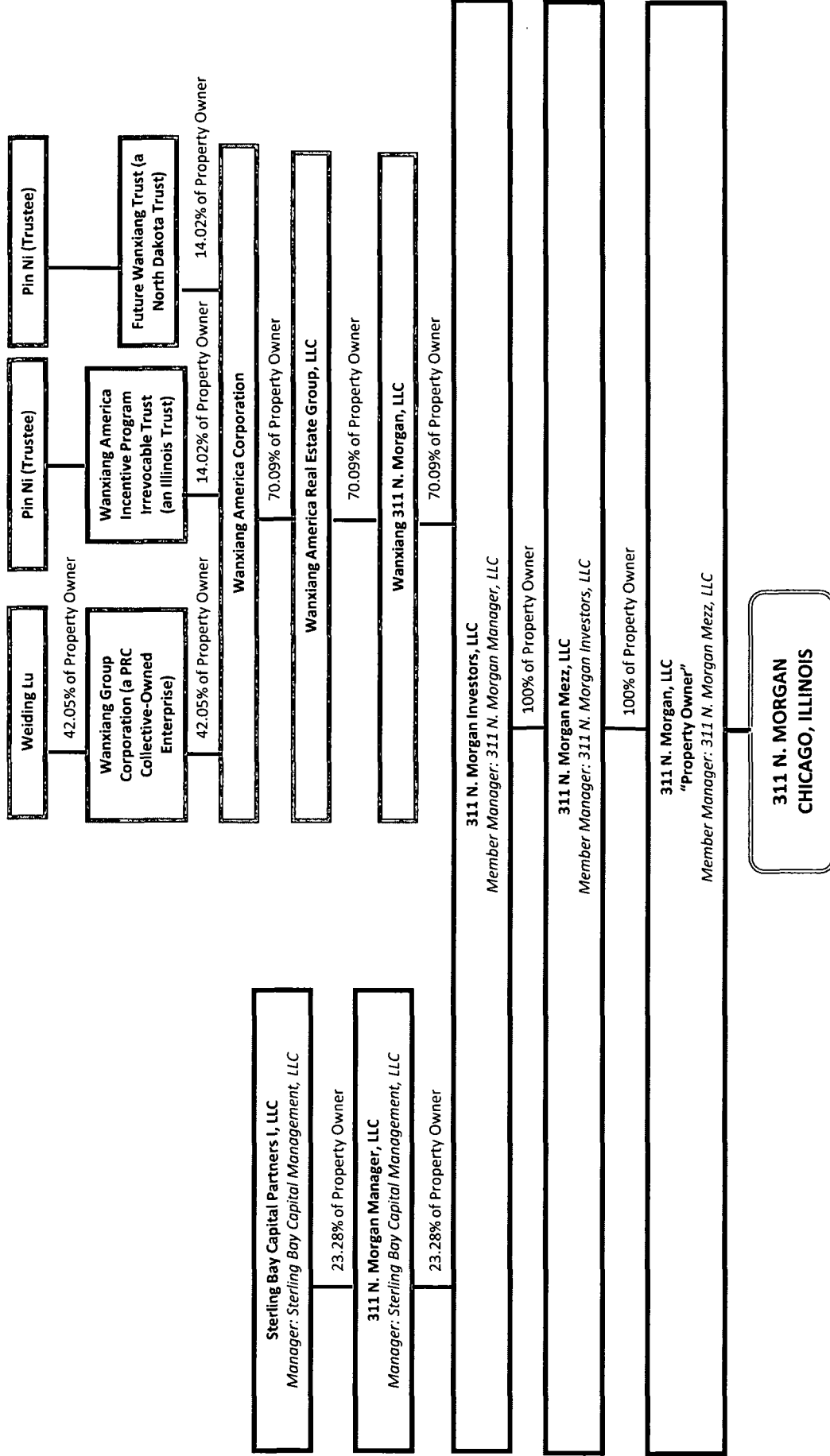

Sterling Bay Capital Partners I, LLC
 Manager: *Sterling Bay Capital Management, LLC*

311 N. Morgan Manager, LLC
 Manager: *Sterling Bay Capital Management, LLC*

311 N. Morgan Investors, LLC
 Member Manager: *311 N. Morgan Manager, LLC*

311 N. Morgan Mezz, LLC
 Member Manager: *311 N. Morgan Investors, LLC*

311 N. Morgan, LLC
 "Property Owner"
 Member Manager: *311 N. Morgan Mezz, LLC*

**311 N. MORGAN
 CHICAGO, ILLINOIS**

*All entities in blue have a business address of 1330 W. Fulton Street, Suite 800, Chicago, IL 60607; Wanxiang America Real Estate Group, LLC has a business address of 150 N. Riverside Plaza, Suite 1810, Chicago, IL 60606; Wanxiang 311 N. Morgan, LLC and Wanxiang America Corporation each have a business address of 88 Airport Rd., Elgin, IL 60123; Wanxiang Group Corporation, Wanxiang America Incentive Program Irrevocable Trust, and Future Wanxiang Trust each have a business address of Xiaoshan Economic and Technological Development Zone, Hanzhou, Zhejiang Province, The People's Republic of China

Name (indicate whether retained or anticipated to be retained)	Business Address	Relationship to Disclosing Party (subcontractor, attorney, lobbyist, etc.)	Fees (indicate whether paid or estimated.) NOTE: "hourly rate" or "t.b.d." is not an acceptable response.
--	------------------	--	--

(Add sheets if necessary)

Check here if the Disclosing Party has not retained, nor expects to retain, any such persons or entities.

SECTION V -- CERTIFICATIONS

A. COURT-ORDERED CHILD SUPPORT COMPLIANCE

Under MCC Section 2-92-415, substantial owners of business entities that contract with the City must remain in compliance with their child support obligations throughout the contract's term.

Has any person who directly or indirectly owns 10% or more of the Disclosing Party been declared in arrearage on any child support obligations by any Illinois court of competent jurisdiction?

Yes No No person directly or indirectly owns 10% or more of the Disclosing Party.

If "Yes," has the person entered into a court-approved agreement for payment of all support owed and is the person in compliance with that agreement?

Yes No

B. FURTHER CERTIFICATIONS

1. [This paragraph 1 applies only if the Matter is a contract being handled by the City's Department of Procurement Services.] In the 5-year period preceding the date of this EDS, neither the Disclosing Party nor any Affiliated Entity [see definition in (5) below] has engaged, in connection with the performance of any public contract, the services of an integrity monitor, independent private sector inspector general, or integrity compliance consultant (i.e., an individual or entity with legal, auditing, investigative, or other similar skills, designated by a public agency to help the agency monitor the activity of specified agency vendors as well as help the vendors reform their business practices so they can be considered for agency contracts in the future, or continue with a contract in progress).

2. The Disclosing Party and its Affiliated Entities are not delinquent in the payment of any fine, fee, tax or other source of indebtedness owed to the City of Chicago, including, but not limited to, water and sewer charges, license fees, parking tickets, property taxes and sales taxes, nor is the Disclosing Party delinquent in the payment of any tax administered by the Illinois Department of Revenue.

3. The Disclosing Party and, if the Disclosing Party is a legal entity, all of those persons or entities identified in Section II(B)(1) of this EDS:
- a. are not presently debarred, suspended, proposed for debarment, declared ineligible or voluntarily excluded from any transactions by any federal, state or local unit of government;
 - b. have not, during the 5 years before the date of this EDS, been convicted of a criminal offense, adjudged guilty, or had a civil judgment rendered against them in connection with: obtaining, attempting to obtain, or performing a public (federal, state or local) transaction or contract under a public transaction; a violation of federal or state antitrust statutes; fraud; embezzlement; theft; forgery; bribery; falsification or destruction of records; making false statements; or receiving stolen property;
 - c. are not presently indicted for, or criminally or civilly charged by, a governmental entity (federal, state or local) with committing any of the offenses set forth in subparagraph (b) above;
 - d. have not, during the 5 years before the date of this EDS, had one or more public transactions (federal, state or local) terminated for cause or default; and
 - e. have not, during the 5 years before the date of this EDS, been convicted, adjudged guilty, or found liable in a civil proceeding, or in any criminal or civil action, including actions concerning environmental violations, instituted by the City or by the federal government, any state, or any other unit of local government.
4. The Disclosing Party understands and shall comply with the applicable requirements of MCC Chapters 2-56 (Inspector General) and 2-156 (Governmental Ethics).
5. Certifications (5), (6) and (7) concern:
- the Disclosing Party;
 - any "Contractor" (meaning any contractor or subcontractor used by the Disclosing Party in connection with the Matter, including but not limited to all persons or legal entities disclosed under Section IV, "Disclosure of Subcontractors and Other Retained Parties");
 - any "Affiliated Entity" (meaning a person or entity that, directly or indirectly: controls the Disclosing Party, is controlled by the Disclosing Party, or is, with the Disclosing Party, under common control of another person or entity). Indicia of control include, without limitation: interlocking management or ownership; identity of interests among family members, shared facilities and equipment; common use of employees; or organization of a business entity following the ineligibility of a business entity to do business with federal or state or local government, including the City, using substantially the same management, ownership, or principals as the ineligible entity. With respect to Contractors, the term Affiliated Entity means a person or entity that directly or indirectly controls the Contractor, is controlled by it, or, with the Contractor, is under common control of another person or entity;
 - any responsible official of the Disclosing Party, any Contractor or any Affiliated Entity or any other official, agent or employee of the Disclosing Party, any Contractor or any Affiliated Entity, acting pursuant to the direction or authorization of a responsible official of the Disclosing Party, any Contractor or any Affiliated Entity (collectively "Agents").

Neither the Disclosing Party, nor any Contractor, nor any Affiliated Entity of either the Disclosing Party or any Contractor, nor any Agents have, during the 5 years before the date of this EDS, or, with respect to a Contractor, an Affiliated Entity, or an Affiliated Entity of a Contractor during the 5 years before the date of such Contractor's or Affiliated Entity's contract or engagement in connection with the Matter:

- a. bribed or attempted to bribe, or been convicted or adjudged guilty of bribery or attempting to bribe, a public officer or employee of the City, the State of Illinois, or any agency of the federal government or of any state or local government in the United States of America, in that officer's or employee's official capacity;
- b. agreed or colluded with other bidders or prospective bidders, or been a party to any such agreement, or been convicted or adjudged guilty of agreement or collusion among bidders or prospective bidders, in restraint of freedom of competition by agreement to bid a fixed price or otherwise; or
- c. made an admission of such conduct described in subparagraph (a) or (b) above that is a matter of record, but have not been prosecuted for such conduct; or
- d. violated the provisions referenced in MCC Subsection 2-92-320(a)(4)(Contracts Requiring a Base Wage); (a)(5)(Debarment Regulations); or (a)(6)(Minimum Wage Ordinance).

6. Neither the Disclosing Party, nor any Affiliated Entity or Contractor, or any of their employees, officials, agents or partners, is barred from contracting with any unit of state or local government as a result of engaging in or being convicted of (1) bid-rigging in violation of 720 ILCS 5/33E-3; (2) bid-rotating in violation of 720 ILCS 5/33E-4; or (3) any similar offense of any state or of the United States of America that contains the same elements as the offense of bid-rigging or bid-rotating.

7. Neither the Disclosing Party nor any Affiliated Entity is listed on a Sanctions List maintained by the United States Department of Commerce, State, or Treasury, or any successor federal agency.

8. ~~PROPERTY OWNER~~ ^{Property Owner} [FOR ~~APPLICANT~~ ONLY] (i) Neither the ~~Applicant~~ ^{Property Owner} nor any "controlling person" [see MCC Chapter 1-23, Article I for applicability and defined terms] of the ~~Applicant~~ ^{Property Owner} is currently indicted or charged with, or has admitted guilt of, or has ever been convicted of, or placed under supervision for, any criminal offense involving actual, attempted, or conspiracy to commit bribery, theft, fraud, forgery, perjury, dishonesty or deceit against an officer or employee of the City or any "sister agency"; and (ii) the ~~Applicant~~ ^{Property Owner} understands and acknowledges that compliance with Article I is a continuing requirement for doing business with the City. NOTE: If MCC Chapter 1-23, Article I applies to the ~~Applicant~~ ^{Property Owner}, that Article's permanent compliance timeframe supersedes 5-year compliance timeframes in this Section V.

9. ~~PROPERTY OWNER~~ ^{Property Owner} [FOR ~~APPLICANT~~ ONLY] The ~~Applicant~~ ^{Property Owner} and its Affiliated Entities will not use, nor permit their subcontractors to use, any facility listed as having an active exclusion by the U.S. EPA on the federal System for Award Management ("SAM").

10. ~~PROPERTY OWNER~~ ^{Property Owner} [FOR ~~APPLICANT~~ ONLY] The ~~Applicant~~ ^{Property Owner} will obtain from any contractors/subcontractors hired or to be hired in connection with the Matter certifications equal in form and substance to those in Certifications (2) and (9) above and will not, without the prior written consent of the City, use any such

contractor/subcontractor that does not provide such certifications or that the ~~Applicant~~ **Property Owner** has reason to believe has not provided or cannot provide truthful certifications.

11. If the Disclosing Party is unable to certify to any of the above statements in this Part B (Further Certifications), the Disclosing Party must explain below:

N/A

If the letters "NA," the word "None," or no response appears on the lines above, it will be conclusively presumed that the Disclosing Party certified to the above statements.

12. To the best of the Disclosing Party's knowledge after reasonable inquiry, the following is a complete list of all current employees of the Disclosing Party who were, at any time during the 12-month period preceding the date of this EDS, an employee, or elected or appointed official, of the City of Chicago (if none, indicate with "N/A" or "none").

N/A

13. To the best of the Disclosing Party's knowledge after reasonable inquiry, the following is a complete list of all gifts that the Disclosing Party has given or caused to be given, at any time during the 12-month period preceding the execution date of this EDS, to an employee, or elected or appointed official, of the City of Chicago. For purposes of this statement, a "gift" does not include: (i) anything made generally available to City employees or to the general public, or (ii) food or drink provided in the course of official City business and having a retail value of less than \$25 per recipient, or (iii) a political contribution otherwise duly reported as required by law (if none, indicate with "N/A" or "none"). As to any gift listed below, please also list the name of the City recipient.

N/A

C. CERTIFICATION OF STATUS AS FINANCIAL INSTITUTION

1. The Disclosing Party certifies that the Disclosing Party (check one)

is is not

a "financial institution" as defined in MCC Section 2-32-455(b).

2. If the Disclosing Party IS a financial institution, then the Disclosing Party pledges:

"We are not and will not become a predatory lender as defined in MCC Chapter 2-32. We further pledge that none of our affiliates is, and none of them will become, a predatory lender as defined in MCC Chapter 2-32. We understand that becoming a predatory lender or becoming an affiliate of a predatory lender may result in the loss of the privilege of doing business with the City."

If the Disclosing Party is unable to make this pledge because it or any of its affiliates (as defined in MCC Section 2-32-455(b)) is a predatory lender within the meaning of MCC Chapter 2-32, explain here (attach additional pages if necessary):

N/A

If the letters "NA," the word "None," or no response appears on the lines above, it will be conclusively presumed that the Disclosing Party certified to the above statements.

D. CERTIFICATION REGARDING FINANCIAL INTEREST IN CITY BUSINESS

Any words or terms defined in MCC Chapter 2-156 have the same meanings if used in this Part D.

1. In accordance with MCC Section 2-156-110: To the best of the Disclosing Party's knowledge after reasonable inquiry, does any official or employee of the City have a financial interest in his or her own name or in the name of any other person or entity in the Matter?

Yes

No

NOTE: If you checked "Yes" to Item D(1), proceed to Items D(2) and D(3). If you checked "No" to Item D(1), skip Items D(2) and D(3) and proceed to Part E.

2. Unless sold pursuant to a process of competitive bidding, or otherwise permitted, no City elected official or employee shall have a financial interest in his or her own name or in the name of any other person or entity in the purchase of any property that (i) belongs to the City, or (ii) is sold for taxes or assessments, or (iii) is sold by virtue of legal process at the suit of the City (collectively, "City Property Sale"). Compensation for property taken pursuant to the City's eminent domain power does not constitute a financial interest within the meaning of this Part D.

Does the Matter involve a City Property Sale?

Yes

No

3. If you checked "Yes" to Item D(1), provide the names and business addresses of the City officials or employees having such financial interest and identify the nature of the financial interest:

Name	Business Address	Nature of Financial Interest
<hr/>		
<hr/>		
<hr/>		

4. The Disclosing Party further certifies that no prohibited financial interest in the Matter will be acquired by any City official or employee.

E. CERTIFICATION REGARDING SLAVERY ERA BUSINESS

Please check either (1) or (2) below. If the Disclosing Party checks (2), the Disclosing Party must disclose below or in an attachment to this EDS all information required by (2). Failure to comply with these disclosure requirements may make any contract entered into with the City in connection with the Matter voidable by the City.

X 1. The Disclosing Party verifies that the Disclosing Party has searched any and all records of the Disclosing Party and any and all predecessor entities regarding records of investments or profits from slavery or slaveholder insurance policies during the slavery era (including insurance policies issued to slaveholders that provided coverage for damage to or injury or death of their slaves), and the Disclosing Party has found no such records.

___ 2. The Disclosing Party verifies that, as a result of conducting the search in step (1) above, the Disclosing Party has found records of investments or profits from slavery or slaveholder insurance policies. The Disclosing Party verifies that the following constitutes full disclosure of all such records, including the names of any and all slaves or slaveholders described in those records:

SECTION VI -- CERTIFICATIONS FOR FEDERALLY FUNDED MATTERS

NOTE: If the Matter is federally funded, complete this Section VI. If the Matter is not federally funded, proceed to Section VII. For purposes of this Section VI, tax credits allocated by the City and proceeds of debt obligations of the City are not federal funding.

A. CERTIFICATION REGARDING LOBBYING

1. List below the names of all persons or entities registered under the federal Lobbying Disclosure Act of 1995, as amended, who have made lobbying contacts on behalf of the Disclosing Party with respect to the Matter: (Add sheets if necessary):

(If no explanation appears or begins on the lines above, or if the letters "NA" or if the word "None" appear, it will be conclusively presumed that the Disclosing Party means that NO persons or entities registered under the Lobbying Disclosure Act of 1995, as amended, have made lobbying contacts on behalf of the Disclosing Party with respect to the Matter.)

2. The Disclosing Party has not spent and will not expend any federally appropriated funds to pay any person or entity listed in paragraph A(1) above for his or her lobbying activities or to pay any person or entity to influence or attempt to influence an officer or employee of any agency, as defined by applicable federal law, a member of Congress, an officer or employee of Congress, or an employee

of a member of Congress, in connection with the award of any federally funded contract, making any federally funded grant or loan, entering into any cooperative agreement, or to extend, continue, renew, amend, or modify any federally funded contract, grant, loan, or cooperative agreement.

3. The Disclosing Party will submit an updated certification at the end of each calendar quarter in which there occurs any event that materially affects the accuracy of the statements and information set forth in paragraphs A(1) and A(2) above.

4. The Disclosing Party certifies that either: (i) it is not an organization described in section 501(c)(4) of the Internal Revenue Code of 1986; or (ii) it is an organization described in section 501(c)(4) of the Internal Revenue Code of 1986 but has not engaged and will not engage in "Lobbying Activities," as that term is defined in the Lobbying Disclosure Act of 1995, as amended.

5. If the Disclosing Party is the ^{Property Owner}~~Applicant~~, the Disclosing Party must obtain certifications equal in form and substance to paragraphs A(1) through A(4) above from all subcontractors before it awards any subcontract and the Disclosing Party must maintain all such subcontractors' certifications for the duration of the Matter and must make such certifications promptly available to the City upon request.

B. CERTIFICATION REGARDING EQUAL EMPLOYMENT OPPORTUNITY

If the Matter is federally funded, federal regulations require the ^{Property Owner}~~Applicant~~ and all proposed subcontractors to submit the following information with their bids or in writing at the outset of negotiations.

Is the Disclosing Party the ^{Property Owner}~~Applicant~~?
 Yes No

If "Yes," answer the three questions below:

1. Have you developed and do you have on file affirmative action programs pursuant to applicable federal regulations? (See 41 CFR Part 60-2.)
 Yes No

2. Have you filed with the Joint Reporting Committee, the Director of the Office of Federal Contract Compliance Programs, or the Equal Employment Opportunity Commission all reports due under the applicable filing requirements?
 Yes No Reports not required

3. Have you participated in any previous contracts or subcontracts subject to the equal opportunity clause?
 Yes No

If you checked "No" to question (1) or (2) above, please provide an explanation:

SECTION VII -- FURTHER ACKNOWLEDGMENTS AND CERTIFICATION

The Disclosing Party understands and agrees that:

A. The certifications, disclosures, and acknowledgments contained in this EDS will become part of any contract or other agreement between the ~~Applicant~~ ^{Property Owner} and the City in connection with the Matter, whether procurement, City assistance, or other City action, and are material inducements to the City's execution of any contract or taking other action with respect to the Matter. The Disclosing Party understands that it must comply with all statutes, ordinances, and regulations on which this EDS is based.

B. The City's Governmental Ethics Ordinance, MCC Chapter 2-156, imposes certain duties and obligations on persons or entities seeking City contracts, work, business, or transactions. The full text of this ordinance and a training program is available on line at www.cityofchicago.org/Ethics, and may also be obtained from the City's Board of Ethics, 740 N. Sedgwick St., Suite 500, Chicago, IL 60610, (312) 744-9660. The Disclosing Party must comply fully with this ordinance.

C. If the City determines that any information provided in this EDS is false, incomplete or inaccurate, any contract or other agreement in connection with which it is submitted may be rescinded or be void or voidable, and the City may pursue any remedies under the contract or agreement (if not rescinded or void), at law, or in equity, including terminating the Disclosing Party's participation in the Matter and/or declining to allow the Disclosing Party to participate in other City transactions. Remedies at law for a false statement of material fact may include incarceration and an award to the City of treble damages.

D. It is the City's policy to make this document available to the public on its Internet site and/or upon request. Some or all of the information provided in, and appended to, this EDS may be made publicly available on the Internet, in response to a Freedom of Information Act request, or otherwise. By completing and signing this EDS, the Disclosing Party waives and releases any possible rights or claims which it may have against the City in connection with the public release of information contained in this EDS and also authorizes the City to verify the accuracy of any information submitted in this EDS.

E. The information provided in this EDS must be kept current. In the event of changes, the Disclosing Party must supplement this EDS up to the time the City takes action on the Matter. If the Matter is a contract being handled by the City's Department of Procurement Services, the Disclosing Party must update this EDS as the contract requires. **NOTE:** With respect to Matters subject to MCC Chapter 1-23, Article I (imposing **PERMANENT INELIGIBILITY** for certain specified offenses), the information provided herein regarding eligibility must be kept current for a longer period, as required by MCC Chapter 1-23 and Section 2-154-020.

CERTIFICATION

Under penalty of perjury, the person signing below: (1) warrants that he/she is authorized to execute this EDS, and all applicable Appendices, on behalf of the Disclosing Party, and (2) warrants that all certifications and statements contained in this EDS, and all applicable Appendices, are true, accurate and complete as of the date furnished to the City.

311 N. MORGAN MANAGER, LLC
(Print or type exact legal name of Disclosing Party)

By: 
(Sign here)

ANDREW GLOOR
(Print or type name of person signing)

Sole manager of Sterling Bay Capital Management, LLC, manager of 311 N. Morgan Manager, LLC
(Print or type title of person signing)

Signed and sworn to before me on (date) 2/26/19,

at Cook County, Illinois (state).

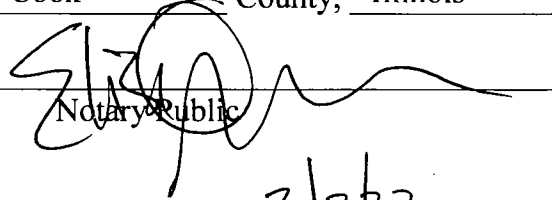
Notary Public



Commission expires: 2/2/22

NOTARY PUBLIC STATE OF CALIFORNIA
MY COMMISSION EXPIRES 03/31/2013
ELISE ORTENGREN
DETROIT, MI

**CITY OF CHICAGO
ECONOMIC DISCLOSURE STATEMENT AND AFFIDAVIT
APPENDIX A**

**FAMILIAL RELATIONSHIPS WITH ELECTED CITY OFFICIALS
AND DEPARTMENT HEADS**

Property Owner
This Appendix is to be completed only by (a) the Applicant, and (b) any legal entity which has a direct ownership interest in the Applicant exceeding 7.5%. It is not to be completed by any legal entity which has only an indirect ownership interest in the Applicant.
Property Owner

Under MCC Section 2-154-015, the Disclosing Party must disclose whether such Disclosing Party or any "Applicable Party" or any Spouse or Domestic Partner thereof currently has a "familial relationship" with any elected city official or department head. A "familial relationship" exists if, as of the date this EDS is signed, the Disclosing Party or any "Applicable Party" or any Spouse or Domestic Partner thereof is related to the mayor, any alderman, the city clerk, the city treasurer or any city department head as spouse or domestic partner or as any of the following, whether by blood or adoption: parent, child, brother or sister, aunt or uncle, niece or nephew, grandparent, grandchild, father-in-law, mother-in-law, son-in-law, daughter-in-law, stepfather or stepmother, stepson or stepdaughter, stepbrother or stepsister or half-brother or half-sister.

"Applicable Party" means (1) all executive officers of the Disclosing Party listed in Section II.B.1.a., if the Disclosing Party is a corporation; all partners of the Disclosing Party, if the Disclosing Party is a general partnership; all general partners and limited partners of the Disclosing Party, if the Disclosing Party is a limited partnership; all managers, managing members and members of the Disclosing Party, if the Disclosing Party is a limited liability company; (2) all principal officers of the Disclosing Party; and (3) any person having more than a 7.5% ownership interest in the Disclosing Party. "Principal officers" means the president, chief operating officer, executive director, chief financial officer, treasurer or secretary of a legal entity or any person exercising similar authority.

Does the Disclosing Party or any "Applicable Party" or any Spouse or Domestic Partner thereof currently have a "familial relationship" with an elected city official or department head?

Yes No

If yes, please identify below (1) the name and title of such person, (2) the name of the legal entity to which such person is connected; (3) the name and title of the elected city official or department head to whom such person has a familial relationship, and (4) the precise nature of such familial relationship.

**CITY OF CHICAGO
ECONOMIC DISCLOSURE STATEMENT AND AFFIDAVIT
APPENDIX B**

BUILDING CODE SCOFFLAW/PROBLEM LANDLORD CERTIFICATION

This Appendix is to be completed only by (a) the ^{Property Owner} ~~Applicant~~, and (b) any legal entity which has a direct ownership interest in the ~~Applicant~~ ^{Property Owner} exceeding 7.5% (an "Owner"). It is not to be completed by any legal entity which has only an indirect ownership interest in the ~~Applicant~~ ^{Property Owner}.

1. Pursuant to MCC Section 2-154-010, is the ^{Property Owner} ~~Applicant~~ or any Owner identified as a building code scofflaw or problem landlord pursuant to MCC Section 2-92-416?

Yes No

2. If the ^{Property Owner} ~~Applicant~~ is a legal entity publicly traded on any exchange, is any officer or director of the ~~Applicant~~ ^{Property Owner} identified as a building code scofflaw or problem landlord pursuant to MCC Section 2-92-416?

Yes No The ^{Property Owner} ~~Applicant~~ is not publicly traded on any exchange.

3. If yes to (1) or (2) above, please identify below the name of each person or legal entity identified as a building code scofflaw or problem landlord and the address of each building or buildings to which the pertinent code violations apply.

**CITY OF CHICAGO
ECONOMIC DISCLOSURE STATEMENT AND AFFIDAVIT
APPENDIX C**

PROHIBITION ON WAGE & SALARY HISTORY SCREENING - CERTIFICATION

This Appendix is to be completed only by an ~~Applicant~~ ^{Property Owner} that is completing this EDS as a “contractor” as defined in MCC Section 2-92-385. That section, which should be consulted (www.amlegal.com), generally covers a party to any agreement pursuant to which they: (i) receive City of Chicago funds in consideration for services, work or goods provided (including for legal or other professional services), or (ii) pay the City money for a license, grant or concession allowing them to conduct a business on City premises.

On behalf of an ~~Applicant~~ ^{Property Owner} that is a contractor pursuant to MCC Section 2-92-385, I hereby certify that the ~~Applicant~~ ^{Property Owner} is in compliance with MCC Section 2-92-385(b)(1) and (2), which prohibit: (i) screening job applicants based on their wage or salary history, or (ii) seeking job applicants’ wage or salary history from current or former employers. I also certify that the ~~Applicant~~ ^{Property Owner} has adopted a policy that includes those prohibitions.

Yes

No

N/A – I am not an ~~Applicant~~ ^{Property Owner} that is a “contractor” as defined in MCC Section 2-92-385.

This certification shall serve as the affidavit required by MCC Section 2-92-385(c)(1).

If you checked “no” to the above, please explain.

**CITY OF CHICAGO
ECONOMIC DISCLOSURE STATEMENT
AND AFFIDAVIT**

SECTION I -- GENERAL INFORMATION

A. Legal name of the Disclosing Party submitting this EDS. Include d/b/a/ if applicable:

STERLING BAY CAPITAL MANAGEMENT, LLC

Check ONE of the following three boxes:

Indicate whether the Disclosing Party submitting this EDS is:

1. the ~~Applicant~~ Property Owner
OR

2. a legal entity currently holding, or anticipated to hold within six months after City action on the contract, transaction or other undertaking to which this EDS pertains (referred to below as the "Matter"), a direct or indirect interest in excess of 7.5% in the ~~Applicant~~. State the ~~Applicant's~~ legal name: Property Owner Property Owner's

OR

Property Owner

3. a legal entity with a direct or indirect right of control of the ~~Applicant~~ (see Section II(B)(1))
State the legal name of the entity in which the Disclosing Party holds a right of control:
311 N. MORGAN, LLC

B. Business address of the Disclosing Party: 1330 W. FULTON ST., SUITE 800
CHICAGO, IL 60607

C. Telephone: 312-466-4142 Fax: 312-874-7008 Email: asimpson@sterlingbay.com

D. Name of contact person: Anna Simpson

E. Federal Employer Identification No. (if you have one): _____

F. Brief description of the Matter to which this EDS pertains. (Include project number and location of property, if applicable):

Application for Planned Development for property commonly known as 345 N. Morgan St., 311 N. Morgan St., and 1000 W. Carroll Ave., Chicago, IL

G. Which City agency or department is requesting this EDS? DPD

If the Matter is a contract being handled by the City's Department of Procurement Services, please complete the following:

Specification # N/A and Contract # N/A

SECTION II -- DISCLOSURE OF OWNERSHIP INTERESTS

A. NATURE OF THE DISCLOSING PARTY

1. Indicate the nature of the Disclosing Party:

- Person
- Limited liability company
- Publicly registered business corporation
- Limited liability partnership
- Privately held business corporation
- Joint venture
- Sole proprietorship
- Not-for-profit corporation
- General partnership
- (Is the not-for-profit corporation also a 501(c)(3))?
- Limited partnership
- Yes No
- Trust
- Other (please specify)

2. For legal entities, the state (or foreign country) of incorporation or organization, if applicable:

Delaware

3. For legal entities not organized in the State of Illinois: Has the organization registered to do business in the State of Illinois as a foreign entity?

- Yes
- No
- Organized in Illinois

B. IF THE DISCLOSING PARTY IS A LEGAL ENTITY:

1. List below the full names and titles, if applicable, of: (i) all executive officers and all directors of the entity; (ii) **for not-for-profit corporations**, all members, if any, which are legal entities (if there are no such members, write "no members which are legal entities"); (iii) **for trusts, estates or other similar entities**, the trustee, executor, administrator, or similarly situated party; (iv) **for general or limited partnerships, limited liability companies, limited liability partnerships or joint ventures**, each general partner, managing member, manager or any other person or legal entity that directly or indirectly controls the day-to-day management of the ~~Applicant~~. **Property Owner**

NOTE: Each legal entity listed below must submit an EDS on its own behalf.

Name	Title
Please refer to Property Owner EDS	

2. Please provide the following information concerning each person or legal entity having a direct or indirect, current or prospective (i.e. within 6 months after City action) beneficial interest (including ownership) in excess of 7.5% of the ~~Applicant~~. **Property Owner** Examples of such an interest include shares in a corporation, partnership interest in a partnership or joint venture, interest of a member or manager in a

limited liability company, or interest of a beneficiary of a trust, estate or other similar entity. If none, state "None."

NOTE: Each legal entity listed below may be required to submit an EDS on its own behalf.

Name	Business Address	Percentage Interest in the	Property Owner
Please see attached Exhibit A			

SECTION III -- INCOME OR COMPENSATION TO, OR OWNERSHIP BY, CITY ELECTED OFFICIALS

Has the Disclosing Party provided any income or compensation to any City elected official during the 12-month period preceding the date of this EDS? [] Yes [X] No

Does the Disclosing Party reasonably expect to provide any income or compensation to any City elected official during the 12-month period following the date of this EDS? [] Yes [X] No

If "yes" to either of the above, please identify below the name(s) of such City elected official(s) and describe such income or compensation:

Does any City elected official or, to the best of the Disclosing Party's knowledge after reasonable inquiry, any City elected official's spouse or domestic partner, have a financial interest (as defined in Chapter 2-156 of the Municipal Code of Chicago ("MCC")) in the Disclosing Party? [] Yes [X] No

If "yes," please identify below the name(s) of such City elected official(s) and/or spouse(s)/domestic partner(s) and describe the financial interest(s).

SECTION IV -- DISCLOSURE OF SUBCONTRACTORS AND OTHER RETAINED PARTIES

The Disclosing Party must disclose the name and business address of each subcontractor, attorney, lobbyist (as defined in MCC Chapter 2-156), accountant, consultant and any other person or entity whom the Disclosing Party has retained or expects to retain in connection with the Matter, as well as the nature of the relationship, and the total amount of the fees paid or estimated to be paid. The Disclosing Party is not required to disclose employees who are paid solely through the Disclosing Party's regular payroll. If the Disclosing Party is uncertain whether a disclosure is required under this Section, the Disclosing Party must either ask the City whether disclosure is required or make the disclosure.

Exhibit A
311 N. MORGAN ORGANIZATIONAL CHART
 "Property Owner"

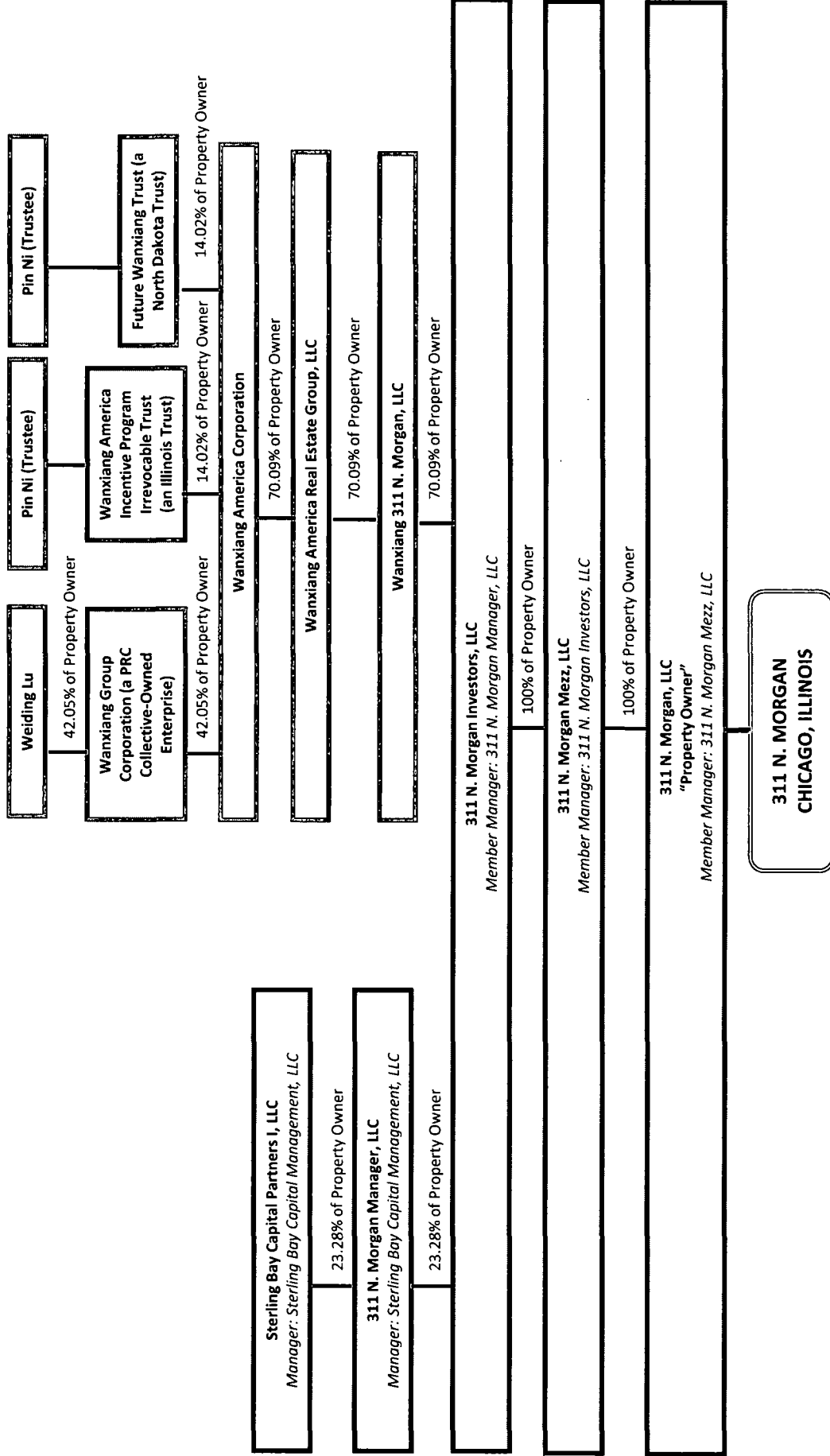

Sterling Bay Capital Partners I, LLC
 Manager: *Sterling Bay Capital Management, LLC*

311 N. Morgan Manager, LLC
 Manager: *Sterling Bay Capital Management, LLC*

23.28% of Property Owner

*All entities in blue have a business address of 1330 W. Fulton Street, Suite 800, Chicago, IL 60607; Wanxiang America Real Estate Group, LLC has a business address of 150 N. Riverside Plaza, Suite 1810, Chicago, IL 60606; Wanxiang 311 N. Morgan, LLC and Wanxiang America Corporation each have a business address of 88 Airport Rd., Elgin, IL 60123; Wanxiang Group Corporation, Wanxiang America Incentive Program Irrevocable Trust, and Future Wanxiang Trust each have a business address of Xiaoshan Economic and Technological Development Zone, Hanzhou, Zhejiang Province, The People's Republic of China

Name (indicate whether retained or anticipated to be retained)	Business Address	Relationship to Disclosing Party (subcontractor, attorney, lobbyist, etc.)	Fees (indicate whether paid or estimated.) NOTE: "hourly rate" or "t.b.d." is not an acceptable response.
--	------------------	--	---

(Add sheets if necessary)

Check here if the Disclosing Party has not retained, nor expects to retain, any such persons or entities.

SECTION V -- CERTIFICATIONS

A. COURT-ORDERED CHILD SUPPORT COMPLIANCE

Under MCC Section 2-92-415, substantial owners of business entities that contract with the City must remain in compliance with their child support obligations throughout the contract's term.

Has any person who directly or indirectly owns 10% or more of the Disclosing Party been declared in arrearage on any child support obligations by any Illinois court of competent jurisdiction?

Yes No No person directly or indirectly owns 10% or more of the Disclosing Party.

If "Yes," has the person entered into a court-approved agreement for payment of all support owed and is the person in compliance with that agreement?

Yes No

B. FURTHER CERTIFICATIONS

1. [This paragraph 1 applies only if the Matter is a contract being handled by the City's Department of Procurement Services.] In the 5-year period preceding the date of this EDS, neither the Disclosing Party nor any Affiliated Entity [see definition in (5) below] has engaged, in connection with the performance of any public contract, the services of an integrity monitor, independent private sector inspector general, or integrity compliance consultant (i.e., an individual or entity with legal, auditing, investigative, or other similar skills, designated by a public agency to help the agency monitor the activity of specified agency vendors as well as help the vendors reform their business practices so they can be considered for agency contracts in the future, or continue with a contract in progress).

2. The Disclosing Party and its Affiliated Entities are not delinquent in the payment of any fine, fee, tax or other source of indebtedness owed to the City of Chicago, including, but not limited to, water and sewer charges, license fees, parking tickets, property taxes and sales taxes, nor is the Disclosing Party delinquent in the payment of any tax administered by the Illinois Department of Revenue.

3. The Disclosing Party and, if the Disclosing Party is a legal entity, all of those persons or entities identified in Section II(B)(1) of this EDS:

- a. are not presently debarred, suspended, proposed for debarment, declared ineligible or voluntarily excluded from any transactions by any federal, state or local unit of government;
- b. have not, during the 5 years before the date of this EDS, been convicted of a criminal offense, adjudged guilty, or had a civil judgment rendered against them in connection with: obtaining, attempting to obtain, or performing a public (federal, state or local) transaction or contract under a public transaction; a violation of federal or state antitrust statutes; fraud; embezzlement; theft; forgery; bribery; falsification or destruction of records; making false statements; or receiving stolen property;
- c. are not presently indicted for, or criminally or civilly charged by, a governmental entity (federal, state or local) with committing any of the offenses set forth in subparagraph (b) above;
- d. have not, during the 5 years before the date of this EDS, had one or more public transactions (federal, state or local) terminated for cause or default; and
- e. have not, during the 5 years before the date of this EDS, been convicted, adjudged guilty, or found liable in a civil proceeding, or in any criminal or civil action, including actions concerning environmental violations, instituted by the City or by the federal government, any state, or any other unit of local government.

4. The Disclosing Party understands and shall comply with the applicable requirements of MCC Chapters 2-56 (Inspector General) and 2-156 (Governmental Ethics).

5. Certifications (5), (6) and (7) concern:

- the Disclosing Party;
- any "Contractor" (meaning any contractor or subcontractor used by the Disclosing Party in connection with the Matter, including but not limited to all persons or legal entities disclosed under Section IV, "Disclosure of Subcontractors and Other Retained Parties");
- any "Affiliated Entity" (meaning a person or entity that, directly or indirectly: controls the Disclosing Party, is controlled by the Disclosing Party, or is, with the Disclosing Party, under common control of another person or entity). Indicia of control include, without limitation: interlocking management or ownership; identity of interests among family members, shared facilities and equipment; common use of employees; or organization of a business entity following the ineligibility of a business entity to do business with federal or state or local government, including the City, using substantially the same management, ownership, or principals as the ineligible entity. With respect to Contractors, the term Affiliated Entity means a person or entity that directly or indirectly controls the Contractor, is controlled by it, or, with the Contractor, is under common control of another person or entity;
- any responsible official of the Disclosing Party, any Contractor or any Affiliated Entity or any other official, agent or employee of the Disclosing Party, any Contractor or any Affiliated Entity, acting pursuant to the direction or authorization of a responsible official of the Disclosing Party, any Contractor or any Affiliated Entity (collectively "Agents").

Neither the Disclosing Party, nor any Contractor, nor any Affiliated Entity of either the Disclosing Party or any Contractor, nor any Agents have, during the 5 years before the date of this EDS, or, with respect to a Contractor, an Affiliated Entity, or an Affiliated Entity of a Contractor during the 5 years before the date of such Contractor's or Affiliated Entity's contract or engagement in connection with the Matter:

- a. bribed or attempted to bribe, or been convicted or adjudged guilty of bribery or attempting to bribe, a public officer or employee of the City, the State of Illinois, or any agency of the federal government or of any state or local government in the United States of America, in that officer's or employee's official capacity;
 - b. agreed or colluded with other bidders or prospective bidders, or been a party to any such agreement, or been convicted or adjudged guilty of agreement or collusion among bidders or prospective bidders, in restraint of freedom of competition by agreement to bid a fixed price or otherwise; or
 - c. made an admission of such conduct described in subparagraph (a) or (b) above that is a matter of record, but have not been prosecuted for such conduct; or
 - d. violated the provisions referenced in MCC Subsection 2-92-320(a)(4)(Contracts Requiring a Base Wage); (a)(5)(Debarment Regulations); or (a)(6)(Minimum Wage Ordinance).
6. Neither the Disclosing Party, nor any Affiliated Entity or Contractor, or any of their employees, officials, agents or partners, is barred from contracting with any unit of state or local government as a result of engaging in or being convicted of (1) bid-rigging in violation of 720 ILCS 5/33E-3; (2) bid-rotating in violation of 720 ILCS 5/33E-4; or (3) any similar offense of any state or of the United States of America that contains the same elements as the offense of bid-rigging or bid-rotating.
7. Neither the Disclosing Party nor any Affiliated Entity is listed on a Sanctions List maintained by the United States Department of Commerce, State, or Treasury, or any successor federal agency.

8. [FOR ~~APPLICANT~~ ^{PROPERTY OWNER} ONLY] (i) Neither the ~~Applicant~~ ^{Property Owner} nor any "controlling person" [see MCC Chapter 1-23, Article I for applicability and defined terms] of the ~~Applicant~~ ^{Property Owner} is currently indicted or charged with, or has admitted guilt of, or has ever been convicted of, or placed under supervision for, any criminal offense involving actual, attempted, or conspiracy to commit bribery, theft, fraud, forgery, perjury, dishonesty or deceit against an officer or employee of the City or any "sister agency"; and (ii) the ~~Applicant~~ ^{Property Owner} understands and acknowledges that compliance with Article I is a continuing requirement for doing business with the City. NOTE: If MCC Chapter 1-23, Article I applies to the ~~Applicant~~ ^{Property Owner}, that Article's permanent compliance timeframe supersedes 5-year compliance timeframes in this Section V.

9. [FOR ~~APPLICANT~~ ^{PROPERTY OWNER} ONLY] The ~~Applicant~~ ^{Property Owner} and its Affiliated Entities will not use, nor permit their subcontractors to use, any facility listed as having an active exclusion by the U.S. EPA on the federal System for Award Management ("SAM").

10. [FOR ~~APPLICANT~~ ^{PROPERTY OWNER} ONLY] The ~~Applicant~~ ^{Property Owner} will obtain from any contractors/subcontractors hired or to be hired in connection with the Matter certifications equal in form and substance to those in Certifications (2) and (9) above and will not, without the prior written consent of the City, use any such

contractor/subcontractor that does not provide such certifications or that the ~~Applicant~~ **Property Owner** has reason to believe has not provided or cannot provide truthful certifications.

11. If the Disclosing Party is unable to certify to any of the above statements in this Part B (Further Certifications), the Disclosing Party must explain below:
N/A

If the letters "NA," the word "None," or no response appears on the lines above, it will be conclusively presumed that the Disclosing Party certified to the above statements.

12. To the best of the Disclosing Party's knowledge after reasonable inquiry, the following is a complete list of all current employees of the Disclosing Party who were, at any time during the 12-month period preceding the date of this EDS, an employee, or elected or appointed official, of the City of Chicago (if none, indicate with "N/A" or "none").
N/A

13. To the best of the Disclosing Party's knowledge after reasonable inquiry, the following is a complete list of all gifts that the Disclosing Party has given or caused to be given, at any time during the 12-month period preceding the execution date of this EDS, to an employee, or elected or appointed official, of the City of Chicago. For purposes of this statement, a "gift" does not include: (i) anything made generally available to City employees or to the general public, or (ii) food or drink provided in the course of official City business and having a retail value of less than \$25 per recipient, or (iii) a political contribution otherwise duly reported as required by law (if none, indicate with "N/A" or "none"). As to any gift listed below, please also list the name of the City recipient.
N/A

C. CERTIFICATION OF STATUS AS FINANCIAL INSTITUTION

1. The Disclosing Party certifies that the Disclosing Party (check one)
 is is not

a "financial institution" as defined in MCC Section 2-32-455(b).

2. If the Disclosing Party IS a financial institution, then the Disclosing Party pledges:

"We are not and will not become a predatory lender as defined in MCC Chapter 2-32. We further pledge that none of our affiliates is, and none of them will become, a predatory lender as defined in MCC Chapter 2-32. We understand that becoming a predatory lender or becoming an affiliate of a predatory lender may result in the loss of the privilege of doing business with the City."

If the Disclosing Party is unable to make this pledge because it or any of its affiliates (as defined in MCC Section 2-32-455(b)) is a predatory lender within the meaning of MCC Chapter 2-32, explain here (attach additional pages if necessary):
N/A

If the letters "NA," the word "None," or no response appears on the lines above, it will be conclusively presumed that the Disclosing Party certified to the above statements.

D. CERTIFICATION REGARDING FINANCIAL INTEREST IN CITY BUSINESS

Any words or terms defined in MCC Chapter 2-156 have the same meanings if used in this Part D.

1. In accordance with MCC Section 2-156-110: To the best of the Disclosing Party's knowledge after reasonable inquiry, does any official or employee of the City have a financial interest in his or her own name or in the name of any other person or entity in the Matter?

Yes No

NOTE: If you checked "Yes" to Item D(1), proceed to Items D(2) and D(3). If you checked "No" to Item D(1), skip Items D(2) and D(3) and proceed to Part E.

2. Unless sold pursuant to a process of competitive bidding, or otherwise permitted, no City elected official or employee shall have a financial interest in his or her own name or in the name of any other person or entity in the purchase of any property that (i) belongs to the City, or (ii) is sold for taxes or assessments, or (iii) is sold by virtue of legal process at the suit of the City (collectively, "City Property Sale"). Compensation for property taken pursuant to the City's eminent domain power does not constitute a financial interest within the meaning of this Part D.

Does the Matter involve a City Property Sale?

Yes No

3. If you checked "Yes" to Item D(1), provide the names and business addresses of the City officials or employees having such financial interest and identify the nature of the financial interest:

Name	Business Address	Nature of Financial Interest
------	------------------	------------------------------

4. The Disclosing Party further certifies that no prohibited financial interest in the Matter will be acquired by any City official or employee.

E. CERTIFICATION REGARDING SLAVERY ERA BUSINESS

Please check either (1) or (2) below. If the Disclosing Party checks (2), the Disclosing Party must disclose below or in an attachment to this EDS all information required by (2). Failure to comply with these disclosure requirements may make any contract entered into with the City in connection with the Matter voidable by the City.

X 1. The Disclosing Party verifies that the Disclosing Party has searched any and all records of the Disclosing Party and any and all predecessor entities regarding records of investments or profits from slavery or slaveholder insurance policies during the slavery era (including insurance policies issued to slaveholders that provided coverage for damage to or injury or death of their slaves), and the Disclosing Party has found no such records.

 2. The Disclosing Party verifies that, as a result of conducting the search in step (1) above, the Disclosing Party has found records of investments or profits from slavery or slaveholder insurance policies. The Disclosing Party verifies that the following constitutes full disclosure of all such records, including the names of any and all slaves or slaveholders described in those records:

SECTION VI -- CERTIFICATIONS FOR FEDERALLY FUNDED MATTERS

NOTE: If the Matter is federally funded, complete this Section VI. If the Matter is not federally funded, proceed to Section VII. For purposes of this Section VI, tax credits allocated by the City and proceeds of debt obligations of the City are not federal funding.

A. CERTIFICATION REGARDING LOBBYING

1. List below the names of all persons or entities registered under the federal Lobbying Disclosure Act of 1995, as amended, who have made lobbying contacts on behalf of the Disclosing Party with respect to the Matter: (Add sheets if necessary):

(If no explanation appears or begins on the lines above, or if the letters "NA" or if the word "None" appear, it will be conclusively presumed that the Disclosing Party means that NO persons or entities registered under the Lobbying Disclosure Act of 1995, as amended, have made lobbying contacts on behalf of the Disclosing Party with respect to the Matter.)

2. The Disclosing Party has not spent and will not expend any federally appropriated funds to pay any person or entity listed in paragraph A(1) above for his or her lobbying activities or to pay any person or entity to influence or attempt to influence an officer or employee of any agency, as defined by applicable federal law, a member of Congress, an officer or employee of Congress, or an employee

of a member of Congress, in connection with the award of any federally funded contract, making any federally funded grant or loan, entering into any cooperative agreement, or to extend, continue, renew, amend, or modify any federally funded contract, grant, loan, or cooperative agreement.

3. The Disclosing Party will submit an updated certification at the end of each calendar quarter in which there occurs any event that materially affects the accuracy of the statements and information set forth in paragraphs A(1) and A(2) above.

4. The Disclosing Party certifies that either: (i) it is not an organization described in section 501(c)(4) of the Internal Revenue Code of 1986; or (ii) it is an organization described in section 501(c)(4) of the Internal Revenue Code of 1986 but has not engaged and will not engage in "Lobbying Activities," as that term is defined in the Lobbying Disclosure Act of 1995, as amended.

5. If the Disclosing Party is the ^{Property Owner}~~Applicant~~, the Disclosing Party must obtain certifications equal in form and substance to paragraphs A(1) through A(4) above from all subcontractors before it awards any subcontract and the Disclosing Party must maintain all such subcontractors' certifications for the duration of the Matter and must make such certifications promptly available to the City upon request.

B. CERTIFICATION REGARDING EQUAL EMPLOYMENT OPPORTUNITY

If the Matter is federally funded, federal regulations require the ^{Property Owner}~~Applicant~~ and all proposed subcontractors to submit the following information with their bids or in writing at the outset of negotiations.

Is the Disclosing Party the ^{Property Owner}~~Applicant~~?
 Yes No

If "Yes," answer the three questions below:

1. Have you developed and do you have on file affirmative action programs pursuant to applicable federal regulations? (See 41 CFR Part 60-2.)
 Yes No

2. Have you filed with the Joint Reporting Committee, the Director of the Office of Federal Contract Compliance Programs, or the Equal Employment Opportunity Commission all reports due under the applicable filing requirements?
 Yes No Reports not required

3. Have you participated in any previous contracts or subcontracts subject to the equal opportunity clause?
 Yes No

If you checked "No" to question (1) or (2) above, please provide an explanation:

SECTION VII -- FURTHER ACKNOWLEDGMENTS AND CERTIFICATION

The Disclosing Party understands and agrees that:

A. The certifications, disclosures, and acknowledgments contained in this EDS will become part of any contract or other agreement between the ~~Applicant~~ ^{Property Owner} and the City in connection with the Matter, whether procurement, City assistance, or other City action, and are material inducements to the City's execution of any contract or taking other action with respect to the Matter. The Disclosing Party understands that it must comply with all statutes, ordinances, and regulations on which this EDS is based.

B. The City's Governmental Ethics Ordinance, MCC Chapter 2-156, imposes certain duties and obligations on persons or entities seeking City contracts, work, business, or transactions. The full text of this ordinance and a training program is available on line at www.cityofchicago.org/Ethics, and may also be obtained from the City's Board of Ethics, 740 N. Sedgwick St., Suite 500, Chicago, IL 60610, (312) 744-9660. The Disclosing Party must comply fully with this ordinance.

C. If the City determines that any information provided in this EDS is false, incomplete or inaccurate, any contract or other agreement in connection with which it is submitted may be rescinded or be void or voidable, and the City may pursue any remedies under the contract or agreement (if not rescinded or void), at law, or in equity, including terminating the Disclosing Party's participation in the Matter and/or declining to allow the Disclosing Party to participate in other City transactions. Remedies at law for a false statement of material fact may include incarceration and an award to the City of treble damages.

D. It is the City's policy to make this document available to the public on its Internet site and/or upon request. Some or all of the information provided in, and appended to, this EDS may be made publicly available on the Internet, in response to a Freedom of Information Act request, or otherwise. By completing and signing this EDS, the Disclosing Party waives and releases any possible rights or claims which it may have against the City in connection with the public release of information contained in this EDS and also authorizes the City to verify the accuracy of any information submitted in this EDS.

E. The information provided in this EDS must be kept current. In the event of changes, the Disclosing Party must supplement this EDS up to the time the City takes action on the Matter. If the Matter is a contract being handled by the City's Department of Procurement Services, the Disclosing Party must update this EDS as the contract requires. **NOTE:** With respect to Matters subject to MCC Chapter 1-23, Article I (imposing **PERMANENT INELIGIBILITY** for certain specified offenses), the information provided herein regarding eligibility must be kept current for a longer period, as required by MCC Chapter 1-23 and Section 2-154-020.

CERTIFICATION

Under penalty of perjury, the person signing below: (1) warrants that he/she is authorized to execute this EDS, and all applicable Appendices, on behalf of the Disclosing Party, and (2) warrants that all certifications and statements contained in this EDS, and all applicable Appendices, are true, accurate and complete as of the date furnished to the City.

STERLING BAY CAPITAL MANAGEMENT, LLC

(Print or type exact legal name of Disclosing Party)

By: _____
(Sign here)

ANDREW GLOOR

(Print or type name of person signing)

Sole manager of Sterling Bay Capital Management, LLC

(Print or type title of person signing)

Signed and sworn to before me on (date) 2/26/19,

at Cook County, Illinois (state).

[Signature]
Notary Public

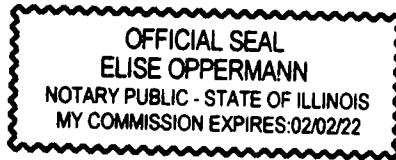

Commission expires: 2/2/22

OFFICIAL SEAL
ELISE OBERMAYER
NOTARY PUBLIC, STATE OF ILLINOIS
MY COMMISSION EXPIRES 03/31/2024

**CITY OF CHICAGO
ECONOMIC DISCLOSURE STATEMENT AND AFFIDAVIT
APPENDIX A**

**FAMILIAL RELATIONSHIPS WITH ELECTED CITY OFFICIALS
AND DEPARTMENT HEADS**

Property Owner
This Appendix is to be completed only by (a) the Applicant, and (b) any legal entity which has a
direct ownership interest in the Applicant exceeding 7.5%. It is not to be completed by any legal
entity which has only an indirect ownership interest in the Applicant.
Property Owner

Under MCC Section 2-154-015, the Disclosing Party must disclose whether such Disclosing Party or any "Applicable Party" or any Spouse or Domestic Partner thereof currently has a "familial relationship" with any elected city official or department head. A "familial relationship" exists if, as of the date this EDS is signed, the Disclosing Party or any "Applicable Party" or any Spouse or Domestic Partner thereof is related to the mayor, any alderman, the city clerk, the city treasurer or any city department head as spouse or domestic partner or as any of the following, whether by blood or adoption: parent, child, brother or sister, aunt or uncle, niece or nephew, grandparent, grandchild, father-in-law, mother-in-law, son-in-law, daughter-in-law, stepfather or stepmother, stepson or stepdaughter, stepbrother or stepsister or half-brother or half-sister.

"Applicable Party" means (1) all executive officers of the Disclosing Party listed in Section II.B.1.a., if the Disclosing Party is a corporation; all partners of the Disclosing Party, if the Disclosing Party is a general partnership; all general partners and limited partners of the Disclosing Party, if the Disclosing Party is a limited partnership; all managers, managing members and members of the Disclosing Party, if the Disclosing Party is a limited liability company; (2) all principal officers of the Disclosing Party; and (3) any person having more than a 7.5% ownership interest in the Disclosing Party. "Principal officers" means the president, chief operating officer, executive director, chief financial officer, treasurer or secretary of a legal entity or any person exercising similar authority.

Does the Disclosing Party or any "Applicable Party" or any Spouse or Domestic Partner thereof currently have a "familial relationship" with an elected city official or department head?

Yes No

If yes, please identify below (1) the name and title of such person, (2) the name of the legal entity to which such person is connected; (3) the name and title of the elected city official or department head to whom such person has a familial relationship, and (4) the precise nature of such familial relationship.

**CITY OF CHICAGO
ECONOMIC DISCLOSURE STATEMENT AND AFFIDAVIT
APPENDIX B**

BUILDING CODE SCOFFLAW/PROBLEM LANDLORD CERTIFICATION

This Appendix is to be completed only by (a) the ~~Applicant~~^{Property Owner}, and (b) any legal entity which has a direct ownership interest in the ~~Applicant~~^{Property Owner} exceeding 7.5% (an "Owner"). It is not to be completed by any legal entity which has only an indirect ownership interest in the ~~Applicant~~^{Property Owner}.

1. Pursuant to MCC Section 2-154-010, is the ~~Applicant~~^{Property Owner} or any Owner identified as a building code scofflaw or problem landlord pursuant to MCC Section 2-92-416?

Yes No

2. If the ~~Applicant~~^{Property Owner} is a legal entity publicly traded on any exchange, is any officer or director of the ~~Applicant~~^{Property Owner} identified as a building code scofflaw or problem landlord pursuant to MCC Section 2-92-416?

Yes No The ~~Applicant~~^{Property Owner} is not publicly traded on any exchange.

3. If yes to (1) or (2) above, please identify below the name of each person or legal entity identified as a building code scofflaw or problem landlord and the address of each building or buildings to which the pertinent code violations apply.

**CITY OF CHICAGO
ECONOMIC DISCLOSURE STATEMENT AND AFFIDAVIT
APPENDIX C**

PROHIBITION ON WAGE & SALARY HISTORY SCREENING - CERTIFICATION

This Appendix is to be completed only by an ~~Applicant~~ ^{Property Owner} that is completing this EDS as a “contractor” as defined in MCC Section 2-92-385. That section, which should be consulted (www.amlegal.com), generally covers a party to any agreement pursuant to which they: (i) receive City of Chicago funds in consideration for services, work or goods provided (including for legal or other professional services), or (ii) pay the City money for a license, grant or concession allowing them to conduct a business on City premises.

On behalf of an ~~Applicant~~ ^{Property Owner} that is a contractor pursuant to MCC Section 2-92-385, I hereby certify that the ~~Applicant~~ ^{Property Owner} is in compliance with MCC Section 2-92-385(b)(1) and (2), which prohibit: (i) screening job applicants based on their wage or salary history, or (ii) seeking job applicants’ wage or salary history from current or former employers. I also certify that the ~~Applicant~~ ^{Property Owner} has adopted a policy that includes those prohibitions.

Yes

No

N/A – I am not an ~~Applicant~~ ^{Property Owner} that is a “contractor” as defined in MCC Section 2-92-385.

This certification shall serve as the affidavit required by MCC Section 2-92-385(c)(1).

If you checked “no” to the above, please explain.

**CITY OF CHICAGO
ECONOMIC DISCLOSURE STATEMENT
AND AFFIDAVIT**

SECTION I -- GENERAL INFORMATION

A. Legal name of the Disclosing Party submitting this EDS. Include d/b/a/ if applicable:

STERLING BAY CAPITAL PARTNERS I, LLC

Check ONE of the following three boxes:

Indicate whether the Disclosing Party submitting this EDS is:

1. the ~~Applicant~~ Property Owner
OR

2. a legal entity currently holding, or anticipated to hold within six months after City action on the contract, transaction or other undertaking to which this EDS pertains (referred to below as the "Matter"), a direct or indirect interest in excess of 7.5% in the ~~Applicant~~. State the ~~Applicant's~~ legal name: 311 N. MORGAN, LLC ~~Property Owner~~ Property Owner's

OR Property Owner

3. a legal entity with a direct or indirect right of control of the ~~Applicant~~ (see Section II(B)(1))
State the legal name of the entity in which the Disclosing Party holds a right of control:

B. Business address of the Disclosing Party: 1330 W. FULTON ST., SUITE 800
CHICAGO, IL 60607

C. Telephone: 312-466-4142 Fax: 312-874-7008 Email: asimpson@sterlingbay.com

D. Name of contact person: Anna Simpson

E. Federal Employer Identification No. (if you have one): _____

F. Brief description of the Matter to which this EDS pertains. (Include project number and location of property, if applicable):

Application for Planned Development for property commonly known as 345 N. Morgan St., 311 N.

Morgan St., and 1000 W. Carroll Ave., Chicago, IL

G. Which City agency or department is requesting this EDS? DPD

If the Matter is a contract being handled by the City's Department of Procurement Services, please complete the following:

Specification # N/A and Contract # N/A

SECTION II -- DISCLOSURE OF OWNERSHIP INTERESTS

A. NATURE OF THE DISCLOSING PARTY

1. Indicate the nature of the Disclosing Party:

- Person
- Publicly registered business corporation
- Privately held business corporation
- Sole proprietorship
- General partnership
- Limited partnership
- Trust
- Limited liability company
- Limited liability partnership
- Joint venture
- Not-for-profit corporation
(Is the not-for-profit corporation also a 501(c)(3))?
 Yes No
- Other (please specify)

2. For legal entities, the state (or foreign country) of incorporation or organization, if applicable:

Delaware

3. For legal entities not organized in the State of Illinois: Has the organization registered to do business in the State of Illinois as a foreign entity?

- Yes
- No
- Organized in Illinois

B. IF THE DISCLOSING PARTY IS A LEGAL ENTITY:

1. List below the full names and titles, if applicable, of: (i) all executive officers and all directors of the entity; (ii) **for not-for-profit corporations**, all members, if any, which are legal entities (if there are no such members, write "no members which are legal entities"); (iii) **for trusts, estates or other similar entities**, the trustee, executor, administrator, or similarly situated party; (iv) **for general or limited partnerships, limited liability companies, limited liability partnerships or joint ventures**, each general partner, managing member, manager or any other person or legal entity that directly or indirectly controls the day-to-day management of the ~~Applicant~~ ^{Property Owner}.

NOTE: Each legal entity listed below must submit an EDS on its own behalf.

Name	Title
Please refer to Property Owner EDS	

2. Please provide the following information concerning each person or legal entity having a direct or indirect, current or prospective (i.e. within 6 months after City action) beneficial interest (including ownership) in excess of 7.5% of the ~~Applicant~~ ^{Property Owner}. Examples of such an interest include shares in a corporation, partnership interest in a partnership or joint venture, interest of a member or manager in a

limited liability company, or interest of a beneficiary of a trust, estate or other similar entity. If none, state "None."

NOTE: Each legal entity listed below may be required to submit an EDS on its own behalf.

Name	Business Address	Percentage Interest in the	Property Owner
Please see attached Exhibit A			APPROX

SECTION III -- INCOME OR COMPENSATION TO, OR OWNERSHIP BY, CITY ELECTED OFFICIALS

Has the Disclosing Party provided any income or compensation to any City elected official during the 12-month period preceding the date of this EDS? [] Yes [X] No

Does the Disclosing Party reasonably expect to provide any income or compensation to any City elected official during the 12-month period following the date of this EDS? [] Yes [X] No

If "yes" to either of the above, please identify below the name(s) of such City elected official(s) and describe such income or compensation:

Does any City elected official or, to the best of the Disclosing Party's knowledge after reasonable inquiry, any City elected official's spouse or domestic partner, have a financial interest (as defined in Chapter 2-156 of the Municipal Code of Chicago ("MCC")) in the Disclosing Party?

[] Yes [X] No

If "yes," please identify below the name(s) of such City elected official(s) and/or spouse(s)/domestic partner(s) and describe the financial interest(s).

SECTION IV -- DISCLOSURE OF SUBCONTRACTORS AND OTHER RETAINED PARTIES

The Disclosing Party must disclose the name and business address of each subcontractor, attorney, lobbyist (as defined in MCC Chapter 2-156), accountant, consultant and any other person or entity whom the Disclosing Party has retained or expects to retain in connection with the Matter, as well as the nature of the relationship, and the total amount of the fees paid or estimated to be paid. The Disclosing Party is not required to disclose employees who are paid solely through the Disclosing Party's regular payroll. If the Disclosing Party is uncertain whether a disclosure is required under this Section, the Disclosing Party must either ask the City whether disclosure is required or make the disclosure.

Exhibit A
311 N. MORGAN ORGANIZATIONAL CHART
 "Property Owner"

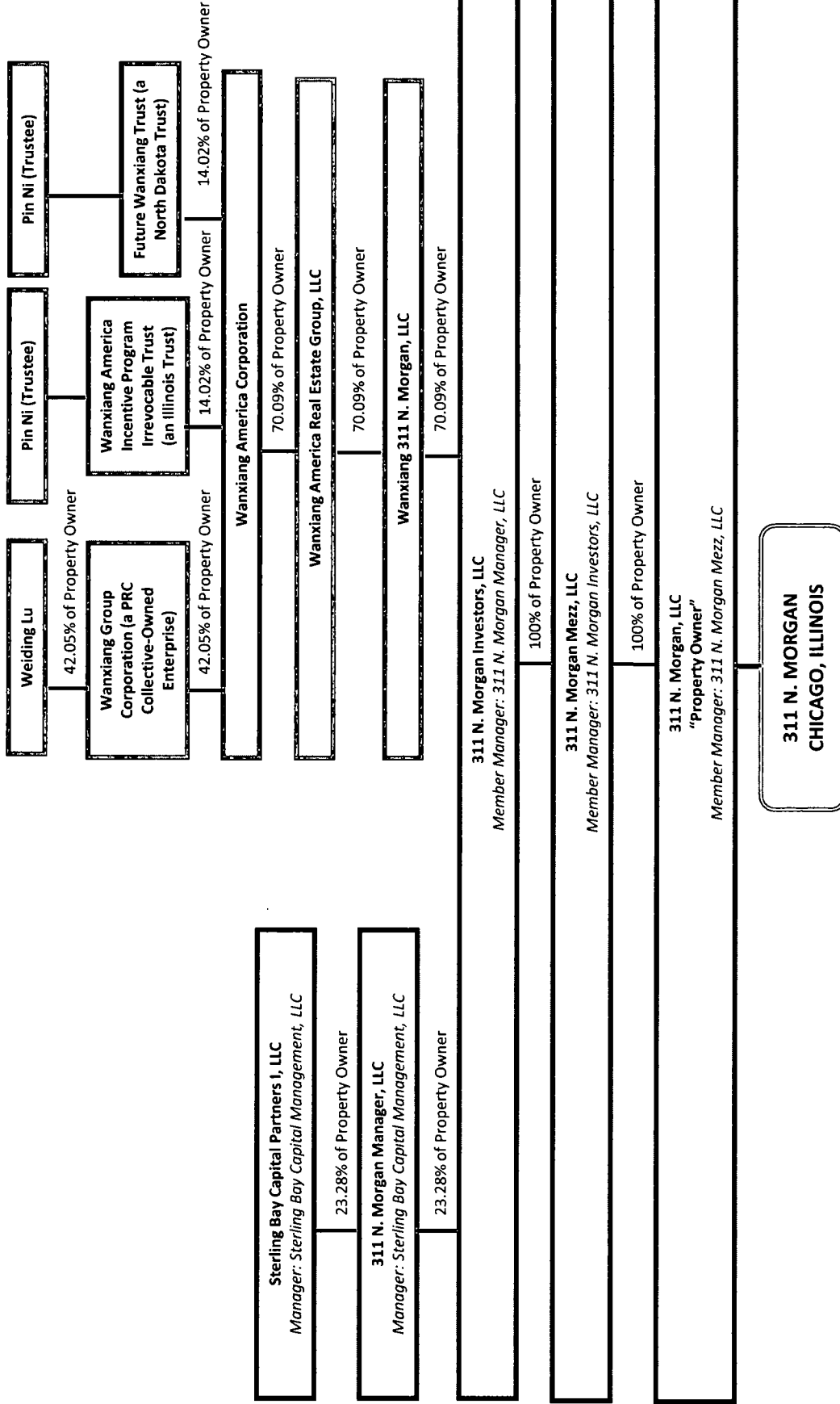

*All entities in blue have a business address of 1330 W. Fulton Street, Suite 800, Chicago, IL 60607; Wanxiang America Real Estate Group, LLC has a business address of 150 N. Riverside Plaza, Suite 1810, Chicago, IL 60606; Wanxiang 311 N. Morgan, LLC and Wanxiang America Corporation each have a business address of 88 Airport Rd., Elgin, IL 60123; Wanxiang Group Corporation, Wanxiang America Incentive Program Irrevocable Trust, and Future Wanxiang Trust each have a business address of Xiaoshan Economic and Technological Development Zone, Hanzhou, Zhejiang Province, The People's Republic of China

Name (indicate whether retained or anticipated to be retained)	Business Address	Relationship to Disclosing Party (subcontractor, attorney, lobbyist, etc.)	Fees (indicate whether paid or estimated.) NOTE: "hourly rate" or "t.b.d." is not an acceptable response.
--	------------------	--	--

(Add sheets if necessary)

Check here if the Disclosing Party has not retained, nor expects to retain, any such persons or entities.

SECTION V -- CERTIFICATIONS

A. COURT-ORDERED CHILD SUPPORT COMPLIANCE

Under MCC Section 2-92-415, substantial owners of business entities that contract with the City must remain in compliance with their child support obligations throughout the contract's term.

Has any person who directly or indirectly owns 10% or more of the Disclosing Party been declared in arrearage on any child support obligations by any Illinois court of competent jurisdiction?

Yes No No person directly or indirectly owns 10% or more of the Disclosing Party.

If "Yes," has the person entered into a court-approved agreement for payment of all support owed and is the person in compliance with that agreement?

Yes No

B. FURTHER CERTIFICATIONS

1. [This paragraph 1 applies only if the Matter is a contract being handled by the City's Department of Procurement Services.] In the 5-year period preceding the date of this EDS, neither the Disclosing Party nor any Affiliated Entity [see definition in (5) below] has engaged, in connection with the performance of any public contract, the services of an integrity monitor, independent private sector inspector general, or integrity compliance consultant (i.e., an individual or entity with legal, auditing, investigative, or other similar skills, designated by a public agency to help the agency monitor the activity of specified agency vendors as well as help the vendors reform their business practices so they can be considered for agency contracts in the future, or continue with a contract in progress).

2. The Disclosing Party and its Affiliated Entities are not delinquent in the payment of any fine, fee, tax or other source of indebtedness owed to the City of Chicago, including, but not limited to, water and sewer charges, license fees, parking tickets, property taxes and sales taxes, nor is the Disclosing Party delinquent in the payment of any tax administered by the Illinois Department of Revenue.

3. The Disclosing Party and, if the Disclosing Party is a legal entity, all of those persons or entities identified in Section II(B)(1) of this EDS:

- a. are not presently debarred, suspended, proposed for debarment, declared ineligible or voluntarily excluded from any transactions by any federal, state or local unit of government;
- b. have not, during the 5 years before the date of this EDS, been convicted of a criminal offense, adjudged guilty, or had a civil judgment rendered against them in connection with: obtaining, attempting to obtain, or performing a public (federal, state or local) transaction or contract under a public transaction; a violation of federal or state antitrust statutes; fraud; embezzlement; theft; forgery; bribery; falsification or destruction of records; making false statements; or receiving stolen property;
- c. are not presently indicted for, or criminally or civilly charged by, a governmental entity (federal, state or local) with committing any of the offenses set forth in subparagraph (b) above;
- d. have not, during the 5 years before the date of this EDS, had one or more public transactions (federal, state or local) terminated for cause or default; and
- e. have not, during the 5 years before the date of this EDS, been convicted, adjudged guilty, or found liable in a civil proceeding, or in any criminal or civil action, including actions concerning environmental violations, instituted by the City or by the federal government, any state, or any other unit of local government.

4. The Disclosing Party understands and shall comply with the applicable requirements of MCC Chapters 2-56 (Inspector General) and 2-156 (Governmental Ethics).

5. Certifications (5), (6) and (7) concern:

- the Disclosing Party;
- any "Contractor" (meaning any contractor or subcontractor used by the Disclosing Party in connection with the Matter, including but not limited to all persons or legal entities disclosed under Section IV, "Disclosure of Subcontractors and Other Retained Parties");
- any "Affiliated Entity" (meaning a person or entity that, directly or indirectly: controls the Disclosing Party, is controlled by the Disclosing Party, or is, with the Disclosing Party, under common control of another person or entity). Indicia of control include, without limitation: interlocking management or ownership; identity of interests among family members, shared facilities and equipment; common use of employees; or organization of a business entity following the ineligibility of a business entity to do business with federal or state or local government, including the City, using substantially the same management, ownership, or principals as the ineligible entity. With respect to Contractors, the term Affiliated Entity means a person or entity that directly or indirectly controls the Contractor, is controlled by it, or, with the Contractor, is under common control of another person or entity;
- any responsible official of the Disclosing Party, any Contractor or any Affiliated Entity or any other official, agent or employee of the Disclosing Party, any Contractor or any Affiliated Entity, acting pursuant to the direction or authorization of a responsible official of the Disclosing Party, any Contractor or any Affiliated Entity (collectively "Agents").

Neither the Disclosing Party, nor any Contractor, nor any Affiliated Entity of either the Disclosing Party or any Contractor, nor any Agents have, during the 5 years before the date of this EDS, or, with respect to a Contractor, an Affiliated Entity, or an Affiliated Entity of a Contractor during the 5 years before the date of such Contractor's or Affiliated Entity's contract or engagement in connection with the Matter:

- a. bribed or attempted to bribe, or been convicted or adjudged guilty of bribery or attempting to bribe, a public officer or employee of the City, the State of Illinois, or any agency of the federal government or of any state or local government in the United States of America, in that officer's or employee's official capacity;
- b. agreed or colluded with other bidders or prospective bidders, or been a party to any such agreement, or been convicted or adjudged guilty of agreement or collusion among bidders or prospective bidders, in restraint of freedom of competition by agreement to bid a fixed price or otherwise; or
- c. made an admission of such conduct described in subparagraph (a) or (b) above that is a matter of record, but have not been prosecuted for such conduct; or
- d. violated the provisions referenced in MCC Subsection 2-92-320(a)(4)(Contracts Requiring a Base Wage); (a)(5)(Debarment Regulations); or (a)(6)(Minimum Wage Ordinance).

6. Neither the Disclosing Party, nor any Affiliated Entity or Contractor, or any of their employees, officials, agents or partners, is barred from contracting with any unit of state or local government as a result of engaging in or being convicted of (1) bid-rigging in violation of 720 ILCS 5/33E-3; (2) bid-rotating in violation of 720 ILCS 5/33E-4; or (3) any similar offense of any state or of the United States of America that contains the same elements as the offense of bid-rigging or bid-rotating.

7. Neither the Disclosing Party nor any Affiliated Entity is listed on a Sanctions List maintained by the United States Department of Commerce, State, or Treasury, or any successor federal agency.

8. [FOR ~~APPLICANT~~ ^{PROPERTY OWNER} ONLY] (i) Neither the ~~Applicant~~ ^{Property Owner} nor any "controlling person" [see MCC Chapter 1-23, Article I for applicability and defined terms] of the ~~Applicant~~ ^{Property Owner} is currently indicted or charged with, or has admitted guilt of, or has ever been convicted of, or placed under supervision for, any criminal offense involving actual, attempted, or conspiracy to commit bribery, theft, fraud, forgery, perjury, dishonesty or deceit against an officer or employee of the City or any "sister agency"; and (ii) the ~~Applicant~~ ^{Property Owner} understands and acknowledges that compliance with Article I is a continuing requirement for doing business with the City. NOTE: If MCC Chapter 1-23, Article I applies to the ~~Applicant~~ ^{Property Owner}, that Article's permanent compliance timeframe supersedes 5-year compliance timeframes in this Section V.

9. [FOR ~~APPLICANT~~ ^{PROPERTY OWNER} ONLY] The ~~Applicant~~ ^{Property Owner} and its Affiliated Entities will not use, nor permit their subcontractors to use, any facility listed as having an active exclusion by the U.S. EPA on the federal System for Award Management ("SAM").

10. [FOR ~~APPLICANT~~ ^{PROPERTY OWNER} ONLY] The ~~Applicant~~ ^{Property Owner} will obtain from any contractors/subcontractors hired or to be hired in connection with the Matter certifications equal in form and substance to those in Certifications (2) and (9) above and will not, without the prior written consent of the City, use any such

contractor/subcontractor that does not provide such certifications or that the Applicant has reason to believe has not provided or cannot provide truthful certifications. ~~Applicant~~ Property Owner

11. If the Disclosing Party is unable to certify to any of the above statements in this Part B (Further Certifications), the Disclosing Party must explain below:

N/A

If the letters "NA," the word "None," or no response appears on the lines above, it will be conclusively presumed that the Disclosing Party certified to the above statements.

12. To the best of the Disclosing Party's knowledge after reasonable inquiry, the following is a complete list of all current employees of the Disclosing Party who were, at any time during the 12-month period preceding the date of this EDS, an employee, or elected or appointed official, of the City of Chicago (if none, indicate with "N/A" or "none").

N/A

13. To the best of the Disclosing Party's knowledge after reasonable inquiry, the following is a complete list of all gifts that the Disclosing Party has given or caused to be given, at any time during the 12-month period preceding the execution date of this EDS, to an employee, or elected or appointed official, of the City of Chicago. For purposes of this statement, a "gift" does not include: (i) anything made generally available to City employees or to the general public, or (ii) food or drink provided in the course of official City business and having a retail value of less than \$25 per recipient, or (iii) a political contribution otherwise duly reported as required by law (if none, indicate with "N/A" or "none"). As to any gift listed below, please also list the name of the City recipient.

N/A

C. CERTIFICATION OF STATUS AS FINANCIAL INSTITUTION

1. The Disclosing Party certifies that the Disclosing Party (check one)

is is not

a "financial institution" as defined in MCC Section 2-32-455(b).

2. If the Disclosing Party IS a financial institution, then the Disclosing Party pledges:

"We are not and will not become a predatory lender as defined in MCC Chapter 2-32. We further pledge that none of our affiliates is, and none of them will become, a predatory lender as defined in MCC Chapter 2-32. We understand that becoming a predatory lender or becoming an affiliate of a predatory lender may result in the loss of the privilege of doing business with the City."

If the Disclosing Party is unable to make this pledge because it or any of its affiliates (as defined in MCC Section 2-32-455(b)) is a predatory lender within the meaning of MCC Chapter 2-32, explain here (attach additional pages if necessary):
N/A

If the letters "NA," the word "None," or no response appears on the lines above, it will be conclusively presumed that the Disclosing Party certified to the above statements.

D. CERTIFICATION REGARDING FINANCIAL INTEREST IN CITY BUSINESS

Any words or terms defined in MCC Chapter 2-156 have the same meanings if used in this Part D.

1. In accordance with MCC Section 2-156-110: To the best of the Disclosing Party's knowledge after reasonable inquiry, does any official or employee of the City have a financial interest in his or her own name or in the name of any other person or entity in the Matter?

Yes No

NOTE: If you checked "Yes" to Item D(1), proceed to Items D(2) and D(3). If you checked "No" to Item D(1), skip Items D(2) and D(3) and proceed to Part E.

2. Unless sold pursuant to a process of competitive bidding, or otherwise permitted, no City elected official or employee shall have a financial interest in his or her own name or in the name of any other person or entity in the purchase of any property that (i) belongs to the City, or (ii) is sold for taxes or assessments, or (iii) is sold by virtue of legal process at the suit of the City (collectively, "City Property Sale"). Compensation for property taken pursuant to the City's eminent domain power does not constitute a financial interest within the meaning of this Part D.

Does the Matter involve a City Property Sale?

Yes No

3. If you checked "Yes" to Item D(1), provide the names and business addresses of the City officials or employees having such financial interest and identify the nature of the financial interest:

Name	Business Address	Nature of Financial Interest
_____	_____	_____
_____	_____	_____
_____	_____	_____

4. The Disclosing Party further certifies that no prohibited financial interest in the Matter will be acquired by any City official or employee.

E. CERTIFICATION REGARDING SLAVERY ERA BUSINESS

Please check either (1) or (2) below. If the Disclosing Party checks (2), the Disclosing Party must disclose below or in an attachment to this EDS all information required by (2). Failure to comply with these disclosure requirements may make any contract entered into with the City in connection with the Matter voidable by the City.

X 1. The Disclosing Party verifies that the Disclosing Party has searched any and all records of the Disclosing Party and any and all predecessor entities regarding records of investments or profits from slavery or slaveholder insurance policies during the slavery era (including insurance policies issued to slaveholders that provided coverage for damage to or injury or death of their slaves), and the Disclosing Party has found no such records.

 2. The Disclosing Party verifies that, as a result of conducting the search in step (1) above, the Disclosing Party has found records of investments or profits from slavery or slaveholder insurance policies. The Disclosing Party verifies that the following constitutes full disclosure of all such records, including the names of any and all slaves or slaveholders described in those records:

SECTION VI -- CERTIFICATIONS FOR FEDERALLY FUNDED MATTERS

NOTE: If the Matter is federally funded, complete this Section VI. If the Matter is not federally funded, proceed to Section VII. For purposes of this Section VI, tax credits allocated by the City and proceeds of debt obligations of the City are not federal funding.

A. CERTIFICATION REGARDING LOBBYING

1. List below the names of all persons or entities registered under the federal Lobbying Disclosure Act of 1995, as amended, who have made lobbying contacts on behalf of the Disclosing Party with respect to the Matter: (Add sheets if necessary):

(If no explanation appears or begins on the lines above, or if the letters "NA" or if the word "None" appear, it will be conclusively presumed that the Disclosing Party means that NO persons or entities registered under the Lobbying Disclosure Act of 1995, as amended, have made lobbying contacts on behalf of the Disclosing Party with respect to the Matter.)

2. The Disclosing Party has not spent and will not expend any federally appropriated funds to pay any person or entity listed in paragraph A(1) above for his or her lobbying activities or to pay any person or entity to influence or attempt to influence an officer or employee of any agency, as defined by applicable federal law, a member of Congress, an officer or employee of Congress, or an employee

of a member of Congress, in connection with the award of any federally funded contract, making any federally funded grant or loan, entering into any cooperative agreement, or to extend, continue, renew, amend, or modify any federally funded contract, grant, loan, or cooperative agreement.

3. The Disclosing Party will submit an updated certification at the end of each calendar quarter in which there occurs any event that materially affects the accuracy of the statements and information set forth in paragraphs A(1) and A(2) above.

4. The Disclosing Party certifies that either: (i) it is not an organization described in section 501(c)(4) of the Internal Revenue Code of 1986; or (ii) it is an organization described in section 501(c)(4) of the Internal Revenue Code of 1986 but has not engaged and will not engage in "Lobbying Activities," as that term is defined in the Lobbying Disclosure Act of 1995, as amended.

5. If the Disclosing Party is the ~~Applicant~~ ^{Property Owner}, the Disclosing Party must obtain certifications equal in form and substance to paragraphs A(1) through A(4) above from all subcontractors before it awards any subcontract and the Disclosing Party must maintain all such subcontractors' certifications for the duration of the Matter and must make such certifications promptly available to the City upon request.

B. CERTIFICATION REGARDING EQUAL EMPLOYMENT OPPORTUNITY

If the Matter is federally funded, federal regulations require the ~~Applicant~~ ^{Property Owner} and all proposed subcontractors to submit the following information with their bids or in writing at the outset of negotiations.

Is the Disclosing Party the ~~Applicant~~ ^{Property Owner}?
 Yes No

If "Yes," answer the three questions below:

1. Have you developed and do you have on file affirmative action programs pursuant to applicable federal regulations? (See 41 CFR Part 60-2.)
 Yes No

2. Have you filed with the Joint Reporting Committee, the Director of the Office of Federal Contract Compliance Programs, or the Equal Employment Opportunity Commission all reports due under the applicable filing requirements?
 Yes No Reports not required

3. Have you participated in any previous contracts or subcontracts subject to the equal opportunity clause?
 Yes No

If you checked "No" to question (1) or (2) above, please provide an explanation:

SECTION VII -- FURTHER ACKNOWLEDGMENTS AND CERTIFICATION

The Disclosing Party understands and agrees that:

A. The certifications, disclosures, and acknowledgments contained in this EDS will become part of any contract or other agreement between the ~~Applicant~~ ^{Property Owner} and the City in connection with the Matter, whether procurement, City assistance, or other City action, and are material inducements to the City's execution of any contract or taking other action with respect to the Matter. The Disclosing Party understands that it must comply with all statutes, ordinances, and regulations on which this EDS is based.

B. The City's Governmental Ethics Ordinance, MCC Chapter 2-156, imposes certain duties and obligations on persons or entities seeking City contracts, work, business, or transactions. The full text of this ordinance and a training program is available on line at www.cityofchicago.org/Ethics, and may also be obtained from the City's Board of Ethics, 740 N. Sedgwick St., Suite 500, Chicago, IL 60610, (312) 744-9660. The Disclosing Party must comply fully with this ordinance.

C. If the City determines that any information provided in this EDS is false, incomplete or inaccurate, any contract or other agreement in connection with which it is submitted may be rescinded or be void or voidable, and the City may pursue any remedies under the contract or agreement (if not rescinded or void), at law, or in equity, including terminating the Disclosing Party's participation in the Matter and/or declining to allow the Disclosing Party to participate in other City transactions. Remedies at law for a false statement of material fact may include incarceration and an award to the City of treble damages.

D. It is the City's policy to make this document available to the public on its Internet site and/or upon request. Some or all of the information provided in, and appended to, this EDS may be made publicly available on the Internet, in response to a Freedom of Information Act request, or otherwise. By completing and signing this EDS, the Disclosing Party waives and releases any possible rights or claims which it may have against the City in connection with the public release of information contained in this EDS and also authorizes the City to verify the accuracy of any information submitted in this EDS.

E. The information provided in this EDS must be kept current. In the event of changes, the Disclosing Party must supplement this EDS up to the time the City takes action on the Matter. If the Matter is a contract being handled by the City's Department of Procurement Services, the Disclosing Party must update this EDS as the contract requires. **NOTE:** With respect to Matters subject to MCC Chapter 1-23, Article I (imposing **PERMANENT INELIGIBILITY** for certain specified offenses), the information provided herein regarding eligibility must be kept current for a longer period, as required by MCC Chapter 1-23 and Section 2-154-020.

CERTIFICATION

Under penalty of perjury, the person signing below: (1) warrants that he/she is authorized to execute this EDS, and all applicable Appendices, on behalf of the Disclosing Party, and (2) warrants that all certifications and statements contained in this EDS, and all applicable Appendices, are true, accurate and complete as of the date furnished to the City.

STERLING BAY CAPITAL PARTNERS I, LLC

(Print or type ~~exact legal name~~ of Disclosing Party)

By: _____
(Sign here)

ANDREW GLOOR

(Print or type name of person signing)

Sole manager of Sterling Bay Capital Management, LLC, manager of Sterling Bay Capital Partners I, LLC

(Print or type title of person signing)

Signed and sworn to before me on (date) 2/26/19,

at Cook County, Illinois (state).

[Signature]
Notary Public



Commission expires: 2/2/22

OFFICIAL SEAL
ELISE OPPERMAN
NOTARY PUBLIC STATE OF DELAWARE
MY COMMISSION EXPIRES 03-31-2025

**CITY OF CHICAGO
ECONOMIC DISCLOSURE STATEMENT AND AFFIDAVIT
APPENDIX A**

**FAMILIAL RELATIONSHIPS WITH ELECTED CITY OFFICIALS
AND DEPARTMENT HEADS**

Property Owner
This Appendix is to be completed only by (a) the Applicant, and (b) any legal entity which has a
direct ownership interest in the Applicant exceeding 7.5%. It is not to be completed by any legal
entity which has only an indirect ownership interest in the Applicant.
Property Owner

Under MCC Section 2-154-015, the Disclosing Party must disclose whether such Disclosing Party or any "Applicable Party" or any Spouse or Domestic Partner thereof currently has a "familial relationship" with any elected city official or department head. A "familial relationship" exists if, as of the date this EDS is signed, the Disclosing Party or any "Applicable Party" or any Spouse or Domestic Partner thereof is related to the mayor, any alderman, the city clerk, the city treasurer or any city department head as spouse or domestic partner or as any of the following, whether by blood or adoption: parent, child, brother or sister, aunt or uncle, niece or nephew, grandparent, grandchild, father-in-law, mother-in-law, son-in-law, daughter-in-law, stepfather or stepmother, stepson or stepdaughter, stepbrother or stepsister or half-brother or half-sister.

"Applicable Party" means (1) all executive officers of the Disclosing Party listed in Section II.B.1.a., if the Disclosing Party is a corporation; all partners of the Disclosing Party, if the Disclosing Party is a general partnership; all general partners and limited partners of the Disclosing Party, if the Disclosing Party is a limited partnership; all managers, managing members and members of the Disclosing Party, if the Disclosing Party is a limited liability company; (2) all principal officers of the Disclosing Party; and (3) any person having more than a 7.5% ownership interest in the Disclosing Party. "Principal officers" means the president, chief operating officer, executive director, chief financial officer, treasurer or secretary of a legal entity or any person exercising similar authority.

Does the Disclosing Party or any "Applicable Party" or any Spouse or Domestic Partner thereof currently have a "familial relationship" with an elected city official or department head?

Yes No

If yes, please identify below (1) the name and title of such person, (2) the name of the legal entity to which such person is connected; (3) the name and title of the elected city official or department head to whom such person has a familial relationship, and (4) the precise nature of such familial relationship.

**CITY OF CHICAGO
ECONOMIC DISCLOSURE STATEMENT AND AFFIDAVIT
APPENDIX B**

BUILDING CODE SCOFFLAW/PROBLEM LANDLORD CERTIFICATION

This Appendix is to be completed only by (a) the ^{Property Owner} ~~Applicant~~, and (b) any legal entity which has a direct ownership interest in the ^{Property Owner} ~~Applicant~~ exceeding 7.5% (an "Owner"). It is not to be completed by any legal entity which has only an indirect ownership interest in the ^{Property Owner} ~~Applicant~~. ~~Property Owner~~

1. Pursuant to MCC Section 2-154-010, is the ^{Property Owner} ~~Applicant~~ or any Owner identified as a building code scofflaw or problem landlord pursuant to MCC Section 2-92-416?

Yes No

2. If the ^{Property Owner} ~~Applicant~~ is a legal entity publicly traded on any exchange, is any officer or director of the ^{Property Owner} ~~Applicant~~ identified as a building code scofflaw or problem landlord pursuant to MCC Section 2-92-416?

Yes No The ^{Property Owner} ~~Applicant~~ is not publicly traded on any exchange.

3. If yes to (1) or (2) above, please identify below the name of each person or legal entity identified as a building code scofflaw or problem landlord and the address of each building or buildings to which the pertinent code violations apply.

**CITY OF CHICAGO
ECONOMIC DISCLOSURE STATEMENT AND AFFIDAVIT
APPENDIX C**

PROHIBITION ON WAGE & SALARY HISTORY SCREENING - CERTIFICATION

This Appendix is to be completed only by an ~~Applicant~~ ^{Property Owner} that is completing this EDS as a “contractor” as defined in MCC Section 2-92-385. That section, which should be consulted (www.amlegal.com), generally covers a party to any agreement pursuant to which they: (i) receive City of Chicago funds in consideration for services, work or goods provided (including for legal or other professional services), or (ii) pay the City money for a license, grant or concession allowing them to conduct a business on City premises.

On behalf of an ~~Applicant~~ ^{Property Owner} that is a contractor pursuant to MCC Section 2-92-385, I hereby certify that the ~~Applicant~~ ^{Property Owner} is in compliance with MCC Section 2-92-385(b)(1) and (2), which prohibit: (i) screening job applicants based on their wage or salary history, or (ii) seeking job applicants’ wage or salary history from current or former employers. I also certify that the ~~Applicant~~ ^{Property Owner} has adopted a policy that includes those prohibitions.

Yes

No

N/A – I am not an ~~Applicant~~ ^{Property Owner} that is a “contractor” as defined in MCC Section 2-92-385.

This certification shall serve as the affidavit required by MCC Section 2-92-385(c)(1).

If you checked “no” to the above, please explain.

**CITY OF CHICAGO
ECONOMIC DISCLOSURE STATEMENT
AND AFFIDAVIT**

SECTION I -- GENERAL INFORMATION

A. Legal name of the Disclosing Party submitting this EDS. Include d/b/a/ if applicable:

Wanxiang 311 N. Morgan, LLC

Check ONE of the following three boxes:

Indicate whether the Disclosing Party submitting this EDS is:

1. the Applicant

OR

2. a legal entity currently holding, or anticipated to hold within six months after City action on the contract, transaction or other undertaking to which this EDS pertains (referred to below as the "Matter"), a direct or indirect interest in excess of 7.5% in the ~~ADDITIONAL~~ ~~ADDITIONAL~~ State the ~~ADDITIONAL~~ ~~ADDITIONAL~~ legal name: 311 N. Morgan, LLC ~~Property Owner~~ ~~Property Owner~~

OR

3. a legal entity with a direct or indirect right of control of the Applicant (see Section II(B)(1)) State the legal name of the entity in which the Disclosing Party holds a right of control:

B. Business address of the Disclosing Party: 150 N. Riverside Plaza, Suite 1810
Chicago, IL 60606

C. Telephone: 847-921-7064 Fax: 847-931-4339 Email: _____

D. Name of contact person: Lawrence J. Krueger

E. Federal Employer Identification No. (if you have one): _____

F. Brief description of the Matter to which this EDS pertains. (Include project number and location of property, if applicable):

Application for planned development for property commonly known as 345 N. Morgan St., 311 N. Morgan St., and 1000 W. Carroll, Chicago, IL

G. Which City agency or department is requesting this EDS? DPD

If the Matter is a contract being handled by the City's Department of Procurement Services, please complete the following:

Specification # N/A and Contract # N/A

SECTION II -- DISCLOSURE OF OWNERSHIP INTERESTS

A. NATURE OF THE DISCLOSING PARTY

1. Indicate the nature of the Disclosing Party:

- Person Limited liability company
- Publicly registered business corporation Limited liability partnership
- Privately held business corporation Joint venture
- Sole proprietorship Not-for-profit corporation
- General partnership (Is the not-for-profit corporation also a 501(c)(3))?
- Limited partnership Yes No
- Trust Other (please specify)

2. For legal entities, the state (or foreign country) of incorporation or organization, if applicable:

Illinois

3. For legal entities not organized in the State of Illinois: Has the organization registered to do business in the State of Illinois as a foreign entity?

- Yes No Organized in Illinois

B. IF THE DISCLOSING PARTY IS A LEGAL ENTITY:

1. List below the full names and titles, if applicable, of: (i) all executive officers and all directors of the entity; (ii) **for not-for-profit corporations**, all members, if any, which are legal entities (if there are no such members, write "no members which are legal entities"); (iii) **for trusts, estates or other similar entities**, the trustee, executor, administrator, or similarly situated party; (iv) **for general or limited partnerships, limited liability companies, limited liability partnerships or joint ventures**, each general partner, managing member, manager or any other person or legal entity that directly or indirectly controls the day-to-day management of the ~~Applicant~~ **Property Owner**.

NOTE: Each legal entity listed below must submit an EDS on its own behalf.

Name	Title
None	

2. Please provide the following information concerning each person or legal entity having a direct or indirect, current or prospective (i.e. within 6 months after City action) beneficial interest (including ownership) in excess of 7.5% of the ~~Applicant~~ **Property Owner**. Examples of such an interest include shares in a corporation, partnership interest in a partnership or joint venture, interest of a member or manager in a

limited liability company, or interest of a beneficiary of a trust, estate or other similar entity. If none, state "None."

NOTE: Each legal entity listed below may be required to submit an EDS on its own behalf.

Name	Business Address	Percentage Interest in the	Property Owner Applicant
<u>See attached Exhibit A</u>			

SECTION III -- INCOME OR COMPENSATION TO, OR OWNERSHIP BY, CITY ELECTED OFFICIALS

Has the Disclosing Party provided any income or compensation to any City elected official during the 12-month period preceding the date of this EDS? Yes No

Does the Disclosing Party reasonably expect to provide any income or compensation to any City elected official during the 12-month period following the date of this EDS? Yes No

If "yes" to either of the above, please identify below the name(s) of such City elected official(s) and describe such income or compensation:

Does any City elected official or, to the best of the Disclosing Party's knowledge after reasonable inquiry, any City elected official's spouse or domestic partner, have a financial interest (as defined in Chapter 2-156 of the Municipal Code of Chicago ("MCC")) in the Disclosing Party? Yes No

If "yes," please identify below the name(s) of such City elected official(s) and/or spouse(s)/domestic partner(s) and describe the financial interest(s).

SECTION IV -- DISCLOSURE OF SUBCONTRACTORS AND OTHER RETAINED PARTIES

The Disclosing Party must disclose the name and business address of each subcontractor, attorney, lobbyist (as defined in MCC Chapter 2-156), accountant, consultant and any other person or entity whom the Disclosing Party has retained or expects to retain in connection with the Matter, as well as the nature of the relationship, and the total amount of the fees paid or estimated to be paid. The Disclosing Party is not required to disclose employees who are paid solely through the Disclosing Party's regular payroll. If the Disclosing Party is uncertain whether a disclosure is required under this Section, the Disclosing Party must either ask the City whether disclosure is required or make the disclosure.

Exhibit A
311 N. MORGAN ORGANIZATIONAL CHART
 "Property Owner"

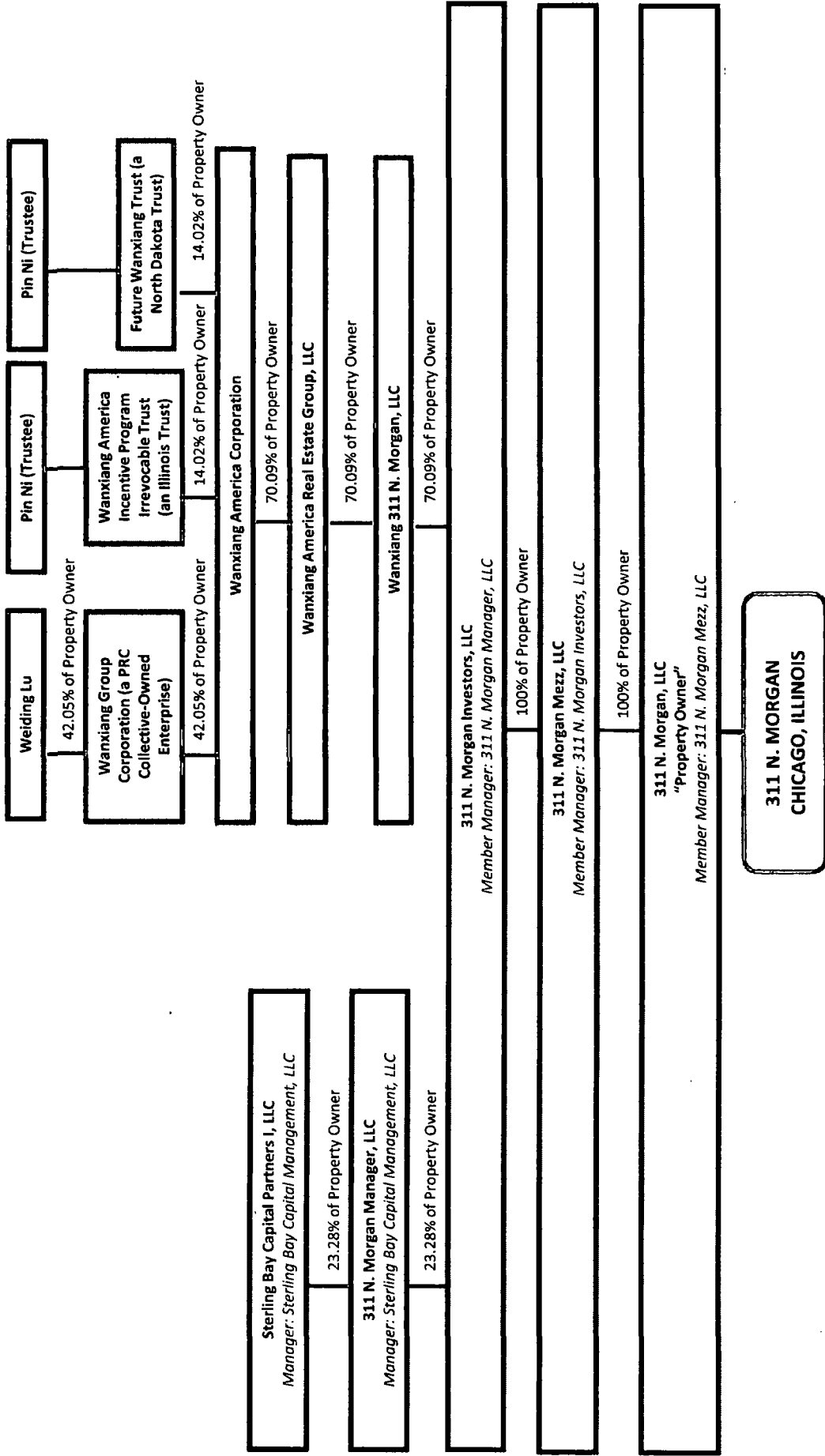

Sterling Bay Capital Partners I, LLC
 Manager: Sterling Bay Capital Management, LLC

23.28% of Property Owner

311 N. Morgan Manager, LLC
 Manager: Sterling Bay Capital Management, LLC

23.28% of Property Owner

311 N. Morgan Investors, LLC
 Member Manager: 311 N. Morgan Manager, LLC

100% of Property Owner

311 N. Morgan Mezz, LLC
 Member Manager: 311 N. Morgan Investors, LLC

100% of Property Owner

311 N. Morgan, LLC
 "Property Owner"
 Member Manager: 311 N. Morgan Mezz, LLC

311 N. MORGAN
CHICAGO, ILLINOIS

* All entities in blue have a business address of 1330 W. Fulton Street, Suite 800, Chicago, IL 60607; Wanxiang America Real Estate Group, LLC has a business address of 150 N. Riverside Plaza, Suite 1810, Chicago, IL 60606; Wanxiang 311 N. Morgan, LLC and Wanxiang America Corporation each have a business address of 88 Airport Rd., Elgin, IL 60123; Wanxiang Group Corporation, Wanxiang America Incentive Program Irrevocable Trust, and Future Wanxiang Trust each have a business address of Xiaoshan Economic and Technological Development Zone, Hanzhou, Zhejiang Province, The People's Republic of China

Name (indicate whether retained or anticipated to be retained)	Business Address	Relationship to Disclosing Party (subcontractor, attorney, lobbyist, etc.)	Fees (<u>indicate whether paid or estimated.</u>) NOTE: "hourly rate" or "t.b.d." is not an acceptable response.
--	------------------	--	---

(Add sheets if necessary)

Check here if the Disclosing Party has not retained, nor expects to retain, any such persons or entities.

SECTION V -- CERTIFICATIONS

A. COURT-ORDERED CHILD SUPPORT COMPLIANCE

Under MCC Section 2-92-415, substantial owners of business entities that contract with the City must remain in compliance with their child support obligations throughout the contract's term.

Has any person who directly or indirectly owns 10% or more of the Disclosing Party been declared in arrearage on any child support obligations by any Illinois court of competent jurisdiction?

Yes No No person directly or indirectly owns 10% or more of the Disclosing Party.

If "Yes," has the person entered into a court-approved agreement for payment of all support owed and is the person in compliance with that agreement?

Yes No

B. FURTHER CERTIFICATIONS

1. [This paragraph 1 applies only if the Matter is a contract being handled by the City's Department of Procurement Services.] In the 5-year period preceding the date of this EDS, neither the Disclosing Party nor any Affiliated Entity [see definition in (5) below] has engaged, in connection with the performance of any public contract, the services of an integrity monitor, independent private sector inspector general, or integrity compliance consultant (i.e., an individual or entity with legal, auditing, investigative, or other similar skills, designated by a public agency to help the agency monitor the activity of specified agency vendors as well as help the vendors reform their business practices so they can be considered for agency contracts in the future, or continue with a contract in progress).

2. The Disclosing Party and its Affiliated Entities are not delinquent in the payment of any fine, fee, tax or other source of indebtedness owed to the City of Chicago, including, but not limited to, water and sewer charges, license fees, parking tickets, property taxes and sales taxes, nor is the Disclosing Party delinquent in the payment of any tax administered by the Illinois Department of Revenue.

3. The Disclosing Party and, if the Disclosing Party is a legal entity, all of those persons or entities identified in Section II(B)(1) of this EDS:
- a. are not presently debarred, suspended, proposed for debarment, declared ineligible or voluntarily excluded from any transactions by any federal, state or local unit of government;
 - b. have not, during the 5 years before the date of this EDS, been convicted of a criminal offense, adjudged guilty, or had a civil judgment rendered against them in connection with: obtaining, attempting to obtain, or performing a public (federal, state or local) transaction or contract under a public transaction; a violation of federal or state antitrust statutes; fraud; embezzlement; theft; forgery; bribery; falsification or destruction of records; making false statements; or receiving stolen property;
 - c. are not presently indicted for, or criminally or civilly charged by, a governmental entity (federal, state or local) with committing any of the offenses set forth in subparagraph (b) above;
 - d. have not, during the 5 years before the date of this EDS, had one or more public transactions (federal, state or local) terminated for cause or default; and
 - e. have not, during the 5 years before the date of this EDS, been convicted, adjudged guilty, or found liable in a civil proceeding, or in any criminal or civil action, including actions concerning environmental violations, instituted by the City or by the federal government, any state, or any other unit of local government.
4. The Disclosing Party understands and shall comply with the applicable requirements of MCC Chapters 2-56 (Inspector General) and 2-156 (Governmental Ethics).
5. Certifications (5), (6) and (7) concern:
- the Disclosing Party;
 - any "Contractor" (meaning any contractor or subcontractor used by the Disclosing Party in connection with the Matter, including but not limited to all persons or legal entities disclosed under Section IV, "Disclosure of Subcontractors and Other Retained Parties");
 - any "Affiliated Entity" (meaning a person or entity that, directly or indirectly: controls the Disclosing Party, is controlled by the Disclosing Party, or is, with the Disclosing Party, under common control of another person or entity). Indicia of control include, without limitation: interlocking management or ownership; identity of interests among family members, shared facilities and equipment; common use of employees; or organization of a business entity following the ineligibility of a business entity to do business with federal or state or local government, including the City, using substantially the same management, ownership, or principals as the ineligible entity. With respect to Contractors, the term Affiliated Entity means a person or entity that directly or indirectly controls the Contractor, is controlled by it, or, with the Contractor, is under common control of another person or entity;
 - any responsible official of the Disclosing Party, any Contractor or any Affiliated Entity or any other official, agent or employee of the Disclosing Party, any Contractor or any Affiliated Entity, acting pursuant to the direction or authorization of a responsible official of the Disclosing Party, any Contractor or any Affiliated Entity (collectively "Agents").

Neither the Disclosing Party, nor any Contractor, nor any Affiliated Entity of either the Disclosing Party or any Contractor, nor any Agents have, during the 5 years before the date of this EDS, or, with respect to a Contractor, an Affiliated Entity, or an Affiliated Entity of a Contractor during the 5 years before the date of such Contractor's or Affiliated Entity's contract or engagement in connection with the Matter:

- a. bribed or attempted to bribe, or been convicted or adjudged guilty of bribery or attempting to bribe, a public officer or employee of the City, the State of Illinois, or any agency of the federal government or of any state or local government in the United States of America, in that officer's or employee's official capacity;
 - b. agreed or colluded with other bidders or prospective bidders, or been a party to any such agreement, or been convicted or adjudged guilty of agreement or collusion among bidders or prospective bidders, in restraint of freedom of competition by agreement to bid a fixed price or otherwise; or
 - c. made an admission of such conduct described in subparagraph (a) or (b) above that is a matter of record, but have not been prosecuted for such conduct; or
 - d. violated the provisions referenced in MCC Subsection 2-92-320(a)(4)(Contracts Requiring a Base Wage); (a)(5)(Debarment Regulations); or (a)(6)(Minimum Wage Ordinance).
6. Neither the Disclosing Party, nor any Affiliated Entity or Contractor, or any of their employees, officials, agents or partners, is barred from contracting with any unit of state or local government as a result of engaging in or being convicted of (1) bid-rigging in violation of 720 ILCS 5/33E-3; (2) bid-rotating in violation of 720 ILCS 5/33E-4; or (3) any similar offense of any state or of the United States of America that contains the same elements as the offense of bid-rigging or bid-rotating.
7. Neither the Disclosing Party nor any Affiliated Entity is listed on a Sanctions List maintained by the United States Department of Commerce, State, or Treasury, or any successor federal agency.
8. [FOR APPLICANT ONLY] (i) Neither the Applicant nor any "controlling person" [see MCC Chapter 1-23, Article I for applicability and defined terms] of the Applicant is currently indicted or charged with, or has admitted guilt of, or has ever been convicted of, or placed under supervision for, any criminal offense involving actual, attempted, or conspiracy to commit bribery, theft, fraud, forgery, perjury, dishonesty or deceit against an officer or employee of the City or any "sister agency"; and (ii) the Applicant understands and acknowledges that compliance with Article I is a continuing requirement for doing business with the City. NOTE: If MCC Chapter 1-23, Article I applies to the Applicant, that Article's permanent compliance timeframe supersedes 5-year compliance timeframes in this Section V.
9. [FOR APPLICANT ONLY] The Applicant and its Affiliated Entities will not use, nor permit their subcontractors to use, any facility listed as having an active exclusion by the U.S. EPA on the federal System for Award Management ("SAM").
10. [FOR APPLICANT ONLY] The Applicant will obtain from any contractors/subcontractors hired or to be hired in connection with the Matter certifications equal in form and substance to those in Certifications (2) and (9) above and will not, without the prior written consent of the City, use any such

contractor/subcontractor that does not provide such certifications or that the Applicant has reason to believe has not provided or cannot provide truthful certifications.

11. If the Disclosing Party is unable to certify to any of the above statements in this Part B (Further Certifications), the Disclosing Party must explain below:

N/A

If the letters "NA," the word "None," or no response appears on the lines above, it will be conclusively presumed that the Disclosing Party certified to the above statements.

12. To the best of the Disclosing Party's knowledge after reasonable inquiry, the following is a complete list of all current employees of the Disclosing Party who were, at any time during the 12-month period preceding the date of this EDS, an employee, or elected or appointed official, of the City of Chicago (if none, indicate with "N/A" or "none").

N/A

13. To the best of the Disclosing Party's knowledge after reasonable inquiry, the following is a complete list of all gifts that the Disclosing Party has given or caused to be given, at any time during the 12-month period preceding the execution date of this EDS, to an employee, or elected or appointed official, of the City of Chicago. For purposes of this statement, a "gift" does not include: (i) anything made generally available to City employees or to the general public, or (ii) food or drink provided in the course of official City business and having a retail value of less than \$25 per recipient, or (iii) a political contribution otherwise duly reported as required by law (if none, indicate with "N/A" or "none"). As to any gift listed below, please also list the name of the City recipient.

N/A

C. CERTIFICATION OF STATUS AS FINANCIAL INSTITUTION

1. The Disclosing Party certifies that the Disclosing Party (check one)

is is not

a "financial institution" as defined in MCC Section 2-32-455(b).

2. If the Disclosing Party IS a financial institution, then the Disclosing Party pledges:

"We are not and will not become a predatory lender as defined in MCC Chapter 2-32. We further pledge that none of our affiliates is, and none of them will become, a predatory lender as defined in MCC Chapter 2-32. We understand that becoming a predatory lender or becoming an affiliate of a predatory lender may result in the loss of the privilege of doing business with the City."

If the Disclosing Party is unable to make this pledge because it or any of its affiliates (as defined in MCC Section 2-32-455(b)) is a predatory lender within the meaning of MCC Chapter 2-32, explain here (attach additional pages if necessary):

N/A

If the letters "NA," the word "None," or no response appears on the lines above, it will be conclusively presumed that the Disclosing Party certified to the above statements.

D. CERTIFICATION REGARDING FINANCIAL INTEREST IN CITY BUSINESS

Any words or terms defined in MCC Chapter 2-156 have the same meanings if used in this Part D.

1. In accordance with MCC Section 2-156-110: To the best of the Disclosing Party's knowledge after reasonable inquiry, does any official or employee of the City have a financial interest in his or her own name or in the name of any other person or entity in the Matter?

Yes

No

NOTE: If you checked "Yes" to Item D(1), proceed to Items D(2) and D(3). If you checked "No" to Item D(1), skip Items D(2) and D(3) and proceed to Part E.

2. Unless sold pursuant to a process of competitive bidding, or otherwise permitted, no City elected official or employee shall have a financial interest in his or her own name or in the name of any other person or entity in the purchase of any property that (i) belongs to the City, or (ii) is sold for taxes or assessments, or (iii) is sold by virtue of legal process at the suit of the City (collectively, "City Property Sale"). Compensation for property taken pursuant to the City's eminent domain power does not constitute a financial interest within the meaning of this Part D.

Does the Matter involve a City Property Sale?

Yes

No

3. If you checked "Yes" to Item D(1), provide the names and business addresses of the City officials or employees having such financial interest and identify the nature of the financial interest:

Name

Business Address

Nature of Financial Interest

4. The Disclosing Party further certifies that no prohibited financial interest in the Matter will be acquired by any City official or employee.

E. CERTIFICATION REGARDING SLAVERY ERA BUSINESS

Please check either (1) or (2) below. If the Disclosing Party checks (2), the Disclosing Party must disclose below or in an attachment to this EDS all information required by (2). Failure to comply with these disclosure requirements may make any contract entered into with the City in connection with the Matter voidable by the City.

X 1. The Disclosing Party verifies that the Disclosing Party has searched any and all records of the Disclosing Party and any and all predecessor entities regarding records of investments or profits from slavery or slaveholder insurance policies during the slavery era (including insurance policies issued to slaveholders that provided coverage for damage to or injury or death of their slaves), and the Disclosing Party has found no such records.

___ 2. The Disclosing Party verifies that, as a result of conducting the search in step (1) above, the Disclosing Party has found records of investments or profits from slavery or slaveholder insurance policies. The Disclosing Party verifies that the following constitutes full disclosure of all such records, including the names of any and all slaves or slaveholders described in those records:

SECTION VI -- CERTIFICATIONS FOR FEDERALLY FUNDED MATTERS

NOTE: If the Matter is federally funded, complete this Section VI. **If the Matter is not federally funded**, proceed to Section VII. For purposes of this Section VI, tax credits allocated by the City and proceeds of debt obligations of the City are not federal funding.

A. CERTIFICATION REGARDING LOBBYING

1. List below the names of all persons or entities registered under the federal Lobbying Disclosure Act of 1995, as amended, who have made lobbying contacts on behalf of the Disclosing Party with respect to the Matter: (Add sheets if necessary):

(If no explanation appears or begins on the lines above, or if the letters "NA" or if the word "None" appear, it will be conclusively presumed that the Disclosing Party means that NO persons or entities registered under the Lobbying Disclosure Act of 1995, as amended, have made lobbying contacts on behalf of the Disclosing Party with respect to the Matter.)

2. The Disclosing Party has not spent and will not expend any federally appropriated funds to pay any person or entity listed in paragraph A(1) above for his or her lobbying activities or to pay any person or entity to influence or attempt to influence an officer or employee of any agency, as defined by applicable federal law, a member of Congress, an officer or employee of Congress, or an employee

of a member of Congress, in connection with the award of any federally funded contract, making any federally funded grant or loan, entering into any cooperative agreement, or to extend, continue, renew, amend, or modify any federally funded contract, grant, loan, or cooperative agreement.

3. The Disclosing Party will submit an updated certification at the end of each calendar quarter in which there occurs any event that materially affects the accuracy of the statements and information set forth in paragraphs A(1) and A(2) above.

4. The Disclosing Party certifies that either: (i) it is not an organization described in section 501(c)(4) of the Internal Revenue Code of 1986; or (ii) it is an organization described in section 501(c)(4) of the Internal Revenue Code of 1986 but has not engaged and will not engage in "Lobbying Activities," as that term is defined in the Lobbying Disclosure Act of 1995, as amended.

5. If the Disclosing Party is the Applicant, the Disclosing Party must obtain certifications equal in form and substance to paragraphs A(1) through A(4) above from all subcontractors before it awards any subcontract and the Disclosing Party must maintain all such subcontractors' certifications for the duration of the Matter and must make such certifications promptly available to the City upon request.

B. CERTIFICATION REGARDING EQUAL EMPLOYMENT OPPORTUNITY

If the Matter is federally funded, federal regulations require the Applicant and all proposed subcontractors to submit the following information with their bids or in writing at the outset of negotiations.

Is the Disclosing Party the Applicant?

Yes

No

If "Yes," answer the three questions below:

1. Have you developed and do you have on file affirmative action programs pursuant to applicable federal regulations? (See 41 CFR Part 60-2.)

Yes

No

2. Have you filed with the Joint Reporting Committee, the Director of the Office of Federal Contract Compliance Programs, or the Equal Employment Opportunity Commission all reports due under the applicable filing requirements?

Yes

No

Reports not required

3. Have you participated in any previous contracts or subcontracts subject to the equal opportunity clause?

Yes

No

If you checked "No" to question (1) or (2) above, please provide an explanation:

SECTION VII -- FURTHER ACKNOWLEDGMENTS AND CERTIFICATION

The Disclosing Party understands and agrees that:

A. The certifications, disclosures, and acknowledgments contained in this EDS will become part of any contract or other agreement between the ^{Property Owner} ~~APPENDIX~~ and the City in connection with the Matter, whether procurement, City assistance, or other City action, and are material inducements to the City's execution of any contract or taking other action with respect to the Matter. The Disclosing Party understands that it must comply with all statutes, ordinances, and regulations on which this EDS is based.

B. The City's Governmental Ethics Ordinance, MCC Chapter 2-156, imposes certain duties and obligations on persons or entities seeking City contracts, work, business, or transactions. The full text of this ordinance and a training program is available on line at www.cityofchicago.org/Ethics, and may also be obtained from the City's Board of Ethics, 740 N. Sedgwick St., Suite 500, Chicago, IL 60610, (312) 744-9660. The Disclosing Party must comply fully with this ordinance.

C. If the City determines that any information provided in this EDS is false, incomplete or inaccurate, any contract or other agreement in connection with which it is submitted may be rescinded or be void or voidable, and the City may pursue any remedies under the contract or agreement (if not rescinded or void), at law, or in equity, including terminating the Disclosing Party's participation in the Matter and/or declining to allow the Disclosing Party to participate in other City transactions. Remedies at law for a false statement of material fact may include incarceration and an award to the City of treble damages.

D. It is the City's policy to make this document available to the public on its Internet site and/or upon request. Some or all of the information provided in, and appended to, this EDS may be made publicly available on the Internet, in response to a Freedom of Information Act request, or otherwise. By completing and signing this EDS, the Disclosing Party waives and releases any possible rights or claims which it may have against the City in connection with the public release of information contained in this EDS and also authorizes the City to verify the accuracy of any information submitted in this EDS.

E. The information provided in this EDS must be kept current. In the event of changes, the Disclosing Party must supplement this EDS up to the time the City takes action on the Matter. If the Matter is a contract being handled by the City's Department of Procurement Services, the Disclosing Party must update this EDS as the contract requires. **NOTE:** With respect to Matters subject to MCC Chapter 1-23, Article I (imposing **PERMANENT INELIGIBILITY** for certain specified offenses), the information provided herein regarding eligibility must be kept current for a longer period, as required by MCC Chapter 1-23 and Section 2-154-020.

CERTIFICATION

Under penalty of perjury, the person signing below: (1) warrants that he/she is authorized to execute this EDS, and all applicable Appendices, on behalf of the Disclosing Party, and (2) warrants that all certifications and statements contained in this EDS, and all applicable Appendices, are true, accurate and complete as of the date furnished to the City.

Wanxiang 311 N. Morgan, LLC

(Print or type exact legal name of Disclosing Party)

By: 
(Sign here)

Managing Director
(Print or type name of person signing)

Lawrence S. Krueger
(Print or type title of person signing)

Signed and sworn to before me on (date) 2/20/19.

at Cook County, Illinois (state).

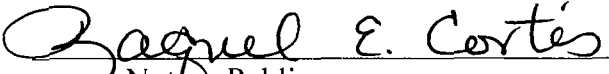
Notary Public



Commission expires: 4/30/22

NOTARY PUBLIC STATE OF ILLINOIS
MY COMM. EXPIRES 03/31/2011

**CITY OF CHICAGO
ECONOMIC DISCLOSURE STATEMENT AND AFFIDAVIT
APPENDIX A**

**FAMILIAL RELATIONSHIPS WITH ELECTED CITY OFFICIALS
AND DEPARTMENT HEADS**

Property Owner

This Appendix is to be completed only by (a) the Applicant, and (b) any legal entity which has a direct ownership interest in the Applicant exceeding 7.5%. It is not to be completed by any legal entity which has only an indirect ownership interest in the Applicant.

Property Owner

Under MCC Section 2-154-015, the Disclosing Party must disclose whether such Disclosing Party or any "Applicable Party" or any Spouse or Domestic Partner thereof currently has a "familial relationship" with any elected city official or department head. A "familial relationship" exists if, as of the date this EDS is signed, the Disclosing Party or any "Applicable Party" or any Spouse or Domestic Partner thereof is related to the mayor, any alderman, the city clerk, the city treasurer or any city department head as spouse or domestic partner or as any of the following, whether by blood or adoption: parent, child, brother or sister, aunt or uncle, niece or nephew, grandparent, grandchild, father-in-law, mother-in-law, son-in-law, daughter-in-law, stepfather or stepmother, stepson or stepdaughter, stepbrother or stepsister or half-brother or half-sister.

"Applicable Party" means (1) all executive officers of the Disclosing Party listed in Section II.B.1.a., if the Disclosing Party is a corporation; all partners of the Disclosing Party, if the Disclosing Party is a general partnership; all general partners and limited partners of the Disclosing Party, if the Disclosing Party is a limited partnership; all managers, managing members and members of the Disclosing Party, if the Disclosing Party is a limited liability company; (2) all principal officers of the Disclosing Party; and (3) any person having more than a 7.5% ownership interest in the Disclosing Party. "Principal officers" means the president, chief operating officer, executive director, chief financial officer, treasurer or secretary of a legal entity or any person exercising similar authority.

Does the Disclosing Party or any "Applicable Party" or any Spouse or Domestic Partner thereof currently have a "familial relationship" with an elected city official or department head?

Yes No

If yes, please identify below (1) the name and title of such person, (2) the name of the legal entity to which such person is connected; (3) the name and title of the elected city official or department head to whom such person has a familial relationship, and (4) the precise nature of such familial relationship.

**CITY OF CHICAGO
ECONOMIC DISCLOSURE STATEMENT AND AFFIDAVIT
APPENDIX B**

BUILDING CODE SCOFFLAW/PROBLEM LANDLORD CERTIFICATION

This Appendix is to be completed only by (a) the ^{Property Owner} ~~Applicant~~ and (b) any legal entity which has a direct ownership interest in the ^{Property Owner} ~~Applicant~~ exceeding 7.5% (an "Owner"). It is not to be completed by any legal entity which has only an indirect ownership interest in the ^{Property Owner} ~~Applicant~~.

1. Pursuant to MCC Section 2-154-010, is the ^{Property Owner} ~~Applicant~~ or any Owner identified as a building code scofflaw or problem landlord pursuant to MCC Section 2-92-416?

Yes No

2. If the ^{Property Owner} ~~Applicant~~ is a legal entity publicly traded on any exchange, is any officer or director of the ^{Property Owner} ~~Applicant~~ identified as a building code scofflaw or problem landlord pursuant to MCC Section 2-92-416?

Yes No The ^{Property Owner} ~~Applicant~~ is not publicly traded on any exchange.

3. If yes to (1) or (2) above, please identify below the name of each person or legal entity identified as a building code scofflaw or problem landlord and the address of each building or buildings to which the pertinent code violations apply.

**CITY OF CHICAGO
ECONOMIC DISCLOSURE STATEMENT AND AFFIDAVIT
APPENDIX C**

PROHIBITION ON WAGE & SALARY HISTORY SCREENING - CERTIFICATION

Property Owner

This Appendix is to be completed only by an ~~Applicant~~ that is completing this EDS as a “contractor” as defined in MCC Section 2-92-385. That section, which should be consulted (www.amlegal.com), generally covers a party to any agreement pursuant to which they: (i) receive City of Chicago funds in consideration for services, work or goods provided (including for legal or other professional services), or (ii) pay the City money for a license, grant or concession allowing them to conduct a business on City premises.

Property Owner

On behalf of an ~~Applicant~~ that is a contractor pursuant to MCC Section 2-92-385, I hereby certify that the ~~Applicant~~ is in compliance with MCC Section 2-92-385(b)(1) and (2), which prohibit: (i) screening job applicants based on their wage or salary history, or (ii) seeking job applicants’ wage or salary history from current or former employers. I also certify that the ~~Applicant~~ has adopted a policy that includes those prohibitions.

Yes

No

Property Owner

N/A – I am not an ~~Applicant~~ that is a “contractor” as defined in MCC Section 2-92-385.

This certification shall serve as the affidavit required by MCC Section 2-92-385(c)(1).

If you checked “no” to the above, please explain.

**CITY OF CHICAGO
ECONOMIC DISCLOSURE STATEMENT
AND AFFIDAVIT**

SECTION I -- GENERAL INFORMATION

A. Legal name of the Disclosing Party submitting this EDS. Include d/b/a/ if applicable:

Wanxiang America Real Estate Group, LLC

Check ONE of the following three boxes:

Indicate whether the Disclosing Party submitting this EDS is:

1. the Applicant
OR

2. a legal entity currently holding, or anticipated to hold within six months after City action on the contract, transaction or other undertaking to which this EDS pertains (referred to below as the "Matter"), a direct or indirect interest in excess of 7.5% in the ~~APPLICANT~~. State the ~~APPLICANT'S~~ legal name: 311 N. MORGAN, LLC ~~Property Owner~~ ~~Property Owner~~

3. a legal entity with a direct or indirect right of control of the Applicant (see Section II(B)(1))
State the legal name of the entity in which the Disclosing Party holds a right of control:

B. Business address of the Disclosing Party: 150 N. Riverside Plaza, Suite 1810
Chicago, IL 60606

C. Telephone: 847-921-7064 Fax: 847-931-4339 Email: lkrueger@wanxiang.com

D. Name of contact person: Lawrence J. Krueger

E. Federal Employer Identification No. (if you have one): _____

F. Brief description of the Matter to which this EDS pertains. (Include project number and location of property, if applicable):
Application for planned development for property commonly known as 345 N. Morgan St., 311 N. Morgan St., and 1000 W. Carroll, Chicago, IL

G. Which City agency or department is requesting this EDS? DPD

If the Matter is a contract being handled by the City's Department of Procurement Services, please complete the following:

Specification # N/A and Contract # N/A

SECTION II -- DISCLOSURE OF OWNERSHIP INTERESTS

A. NATURE OF THE DISCLOSING PARTY

1. Indicate the nature of the Disclosing Party:

- Person
 - Publicly registered business corporation
 - Privately held business corporation
 - Sole proprietorship
 - General partnership
 - Limited partnership
 - Trust
 - Limited liability company
 - Limited liability partnership
 - Joint venture
 - Not-for-profit corporation
- (Is the not-for-profit corporation also a 501(c)(3))?
 Yes No
 Other (please specify)
-

2. For legal entities, the state (or foreign country) of incorporation or organization, if applicable:

Illinois

3. For legal entities not organized in the State of Illinois: Has the organization registered to do business in the State of Illinois as a foreign entity?

- Yes
- No
- Organized in Illinois

B. IF THE DISCLOSING PARTY IS A LEGAL ENTITY:

1. List below the full names and titles, if applicable, of: (i) all executive officers and all directors of the entity; (ii) **for not-for-profit corporations**, all members, if any, which are legal entities (if there are no such members, write "no members which are legal entities"); (iii) **for trusts, estates or other similar entities**, the trustee, executor, administrator, or similarly situated party; (iv) **for general or limited partnerships, limited liability companies, limited liability partnerships or joint ventures**, each general partner, managing member, manager or any other person or legal entity that directly or indirectly controls the day-to-day management of the ~~Applicant~~ **Property Owner**.

NOTE: Each legal entity listed below must submit an EDS on its own behalf.

Name	Title
<u>Lawrence J. Krueger</u>	<u>Managing Director</u>

2. Please provide the following information concerning each person or legal entity having a direct or indirect, current or prospective (i.e. within 6 months after City action) beneficial interest (including ownership) in excess of 7.5% of the ~~Applicant~~ **Property Owner**. Examples of such an interest include shares in a corporation, partnership interest in a partnership or joint venture, interest of a member or manager in a

limited liability company, or interest of a beneficiary of a trust, estate or other similar entity. If none, state "None."

NOTE: Each legal entity listed below may be required to submit an EDS on its own behalf.

Name	Business Address	Percentage Interest in the	Property Owner
See attached Exhibit A			Applicant

SECTION III -- INCOME OR COMPENSATION TO, OR OWNERSHIP BY, CITY ELECTED OFFICIALS

Has the Disclosing Party provided any income or compensation to any City elected official during the 12-month period preceding the date of this EDS? [] Yes [X] No

Does the Disclosing Party reasonably expect to provide any income or compensation to any City elected official during the 12-month period following the date of this EDS? [] Yes [X] No

If "yes" to either of the above, please identify below the name(s) of such City elected official(s) and describe such income or compensation:

Does any City elected official or, to the best of the Disclosing Party's knowledge after reasonable inquiry, any City elected official's spouse or domestic partner, have a financial interest (as defined in Chapter 2-156 of the Municipal Code of Chicago ("MCC")) in the Disclosing Party?

[] Yes [X] No

If "yes," please identify below the name(s) of such City elected official(s) and/or spouse(s)/domestic partner(s) and describe the financial interest(s).

SECTION IV -- DISCLOSURE OF SUBCONTRACTORS AND OTHER RETAINED PARTIES

The Disclosing Party must disclose the name and business address of each subcontractor, attorney, lobbyist (as defined in MCC Chapter 2-156), accountant, consultant and any other person or entity whom the Disclosing Party has retained or expects to retain in connection with the Matter, as well as the nature of the relationship, and the total amount of the fees paid or estimated to be paid. The Disclosing Party is not required to disclose employees who are paid solely through the Disclosing Party's regular payroll. If the Disclosing Party is uncertain whether a disclosure is required under this Section, the Disclosing Party must either ask the City whether disclosure is required or make the disclosure.

Exhibit A
311 N. MORGAN ORGANIZATIONAL CHART
 "Property Owner"

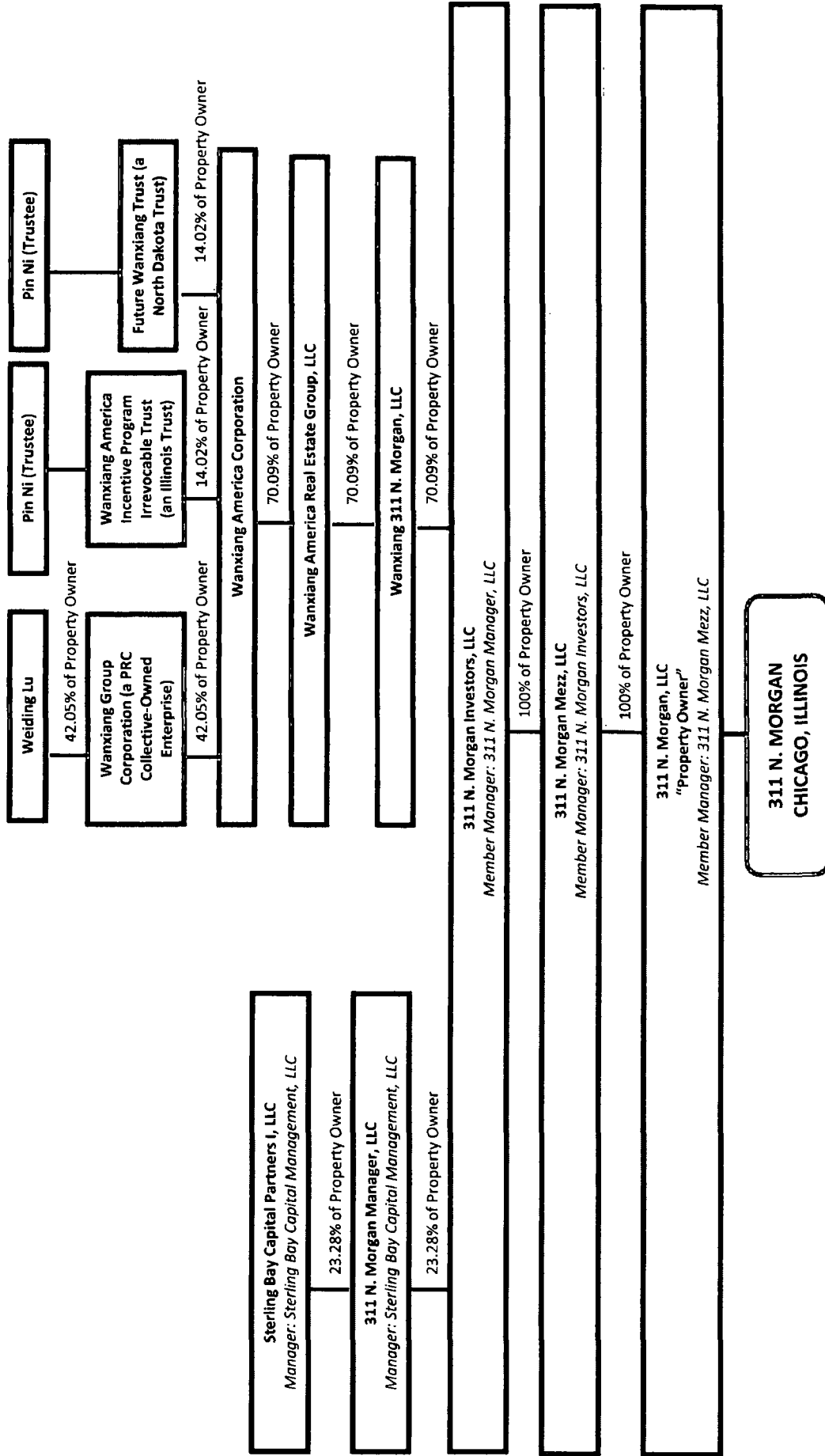

*All entities in blue have a business address of 1330 W. Fulton Street, Suite 800, Chicago, IL 60607; Wanxiang America Real Estate Group, LLC has a business address of 150 N. Riverside Plaza, Suite 1810, Chicago, IL 60606; Wanxiang 311 N. Morgan, LLC and Wanxiang America Corporation each have a business address of 88 Airport Rd., Elgin, IL 60123; Wanxiang Group Corporation, Wanxiang America Incentive Program Irrevocable Trust, and Future Wanxiang Trust each have a business address of Xiaoshan Economic and Technological Development Zone, Hanzhou, Zhejiang Province, The People's Republic of China

Name (indicate whether retained or anticipated to be retained)	Business Address	Relationship to Disclosing Party (subcontractor, attorney, lobbyist, etc.)	Fees (indicate whether paid or estimated.) NOTE: "hourly rate" or "t.b.d." is not an acceptable response.
--	------------------	--	--

(Add sheets if necessary)

Check here if the Disclosing Party has not retained, nor expects to retain, any such persons or entities.

SECTION V -- CERTIFICATIONS

A. COURT-ORDERED CHILD SUPPORT COMPLIANCE

Under MCC Section 2-92-415, substantial owners of business entities that contract with the City must remain in compliance with their child support obligations throughout the contract's term.

Has any person who directly or indirectly owns 10% or more of the Disclosing Party been declared in arrearage on any child support obligations by any Illinois court of competent jurisdiction?

Yes No No person directly or indirectly owns 10% or more of the Disclosing Party.

If "Yes," has the person entered into a court-approved agreement for payment of all support owed and is the person in compliance with that agreement?

Yes No

B. FURTHER CERTIFICATIONS

1. [This paragraph 1 applies only if the Matter is a contract being handled by the City's Department of Procurement Services.] In the 5-year period preceding the date of this EDS, neither the Disclosing Party nor any Affiliated Entity [see definition in (5) below] has engaged, in connection with the performance of any public contract, the services of an integrity monitor, independent private sector inspector general, or integrity compliance consultant (i.e., an individual or entity with legal, auditing, investigative, or other similar skills, designated by a public agency to help the agency monitor the activity of specified agency vendors as well as help the vendors reform their business practices so they can be considered for agency contracts in the future, or continue with a contract in progress).

2. The Disclosing Party and its Affiliated Entities are not delinquent in the payment of any fine, fee, tax or other source of indebtedness owed to the City of Chicago, including, but not limited to, water and sewer charges, license fees, parking tickets, property taxes and sales taxes, nor is the Disclosing Party delinquent in the payment of any tax administered by the Illinois Department of Revenue.

3. The Disclosing Party and, if the Disclosing Party is a legal entity, all of those persons or entities identified in Section II(B)(1) of this EDS:
- a. are not presently debarred, suspended, proposed for debarment, declared ineligible or voluntarily excluded from any transactions by any federal, state or local unit of government;
 - b. have not, during the 5 years before the date of this EDS, been convicted of a criminal offense, adjudged guilty, or had a civil judgment rendered against them in connection with: obtaining, attempting to obtain, or performing a public (federal, state or local) transaction or contract under a public transaction; a violation of federal or state antitrust statutes; fraud; embezzlement; theft; forgery; bribery; falsification or destruction of records; making false statements; or receiving stolen property;
 - c. are not presently indicted for, or criminally or civilly charged by, a governmental entity (federal, state or local) with committing any of the offenses set forth in subparagraph (b) above;
 - d. have not, during the 5 years before the date of this EDS, had one or more public transactions (federal, state or local) terminated for cause or default; and
 - e. have not, during the 5 years before the date of this EDS, been convicted, adjudged guilty, or found liable in a civil proceeding, or in any criminal or civil action, including actions concerning environmental violations, instituted by the City or by the federal government, any state, or any other unit of local government.
4. The Disclosing Party understands and shall comply with the applicable requirements of MCC Chapters 2-56 (Inspector General) and 2-156 (Governmental Ethics).
5. Certifications (5), (6) and (7) concern:
- the Disclosing Party;
 - any "Contractor" (meaning any contractor or subcontractor used by the Disclosing Party in connection with the Matter, including but not limited to all persons or legal entities disclosed under Section IV, "Disclosure of Subcontractors and Other Retained Parties");
 - any "Affiliated Entity" (meaning a person or entity that, directly or indirectly: controls the Disclosing Party, is controlled by the Disclosing Party, or is, with the Disclosing Party, under common control of another person or entity). Indicia of control include, without limitation: interlocking management or ownership; identity of interests among family members, shared facilities and equipment; common use of employees; or organization of a business entity following the ineligibility of a business entity to do business with federal or state or local government, including the City, using substantially the same management, ownership, or principals as the ineligible entity. With respect to Contractors, the term Affiliated Entity means a person or entity that directly or indirectly controls the Contractor, is controlled by it, or, with the Contractor, is under common control of another person or entity;
 - any responsible official of the Disclosing Party, any Contractor or any Affiliated Entity or any other official, agent or employee of the Disclosing Party, any Contractor or any Affiliated Entity, acting pursuant to the direction or authorization of a responsible official of the Disclosing Party, any Contractor or any Affiliated Entity (collectively "Agents").

Neither the Disclosing Party, nor any Contractor, nor any Affiliated Entity of either the Disclosing Party or any Contractor, nor any Agents have, during the 5 years before the date of this EDS, or, with respect to a Contractor, an Affiliated Entity, or an Affiliated Entity of a Contractor during the 5 years before the date of such Contractor's or Affiliated Entity's contract or engagement in connection with the Matter:

- a. bribed or attempted to bribe, or been convicted or adjudged guilty of bribery or attempting to bribe, a public officer or employee of the City, the State of Illinois, or any agency of the federal government or of any state or local government in the United States of America, in that officer's or employee's official capacity;
 - b. agreed or colluded with other bidders or prospective bidders, or been a party to any such agreement, or been convicted or adjudged guilty of agreement or collusion among bidders or prospective bidders, in restraint of freedom of competition by agreement to bid a fixed price or otherwise; or
 - c. made an admission of such conduct described in subparagraph (a) or (b) above that is a matter of record, but have not been prosecuted for such conduct; or
 - d. violated the provisions referenced in MCC Subsection 2-92-320(a)(4)(Contracts Requiring a Base Wage); (a)(5)(Debarment Regulations); or (a)(6)(Minimum Wage Ordinance).
6. Neither the Disclosing Party, nor any Affiliated Entity or Contractor, or any of their employees, officials, agents or partners, is barred from contracting with any unit of state or local government as a result of engaging in or being convicted of (1) bid-rigging in violation of 720 ILCS 5/33E-3; (2) bid-rotating in violation of 720 ILCS 5/33E-4; or (3) any similar offense of any state or of the United States of America that contains the same elements as the offense of bid-rigging or bid-rotating.
7. Neither the Disclosing Party nor any Affiliated Entity is listed on a Sanctions List maintained by the United States Department of Commerce, State, or Treasury, or any successor federal agency.
8. [FOR APPLICANT ONLY] (i) Neither the Applicant nor any "controlling person" [see MCC Chapter 1-23, Article I for applicability and defined terms] of the Applicant is currently indicted or charged with, or has admitted guilt of, or has ever been convicted of, or placed under supervision for, any criminal offense involving actual, attempted, or conspiracy to commit bribery, theft, fraud, forgery, perjury, dishonesty or deceit against an officer or employee of the City or any "sister agency"; and (ii) the Applicant understands and acknowledges that compliance with Article I is a continuing requirement for doing business with the City. NOTE: If MCC Chapter 1-23, Article I applies to the Applicant, that Article's permanent compliance timeframe supersedes 5-year compliance timeframes in this Section V.
9. [FOR APPLICANT ONLY] The Applicant and its Affiliated Entities will not use, nor permit their subcontractors to use, any facility listed as having an active exclusion by the U.S. EPA on the federal System for Award Management ("SAM").
10. [FOR APPLICANT ONLY] The Applicant will obtain from any contractors/subcontractors hired or to be hired in connection with the Matter certifications equal in form and substance to those in Certifications (2) and (9) above and will not, without the prior written consent of the City, use any such

contractor/subcontractor that does not provide such certifications or that the Applicant has reason to believe has not provided or cannot provide truthful certifications.

11. If the Disclosing Party is unable to certify to any of the above statements in this Part B (Further Certifications), the Disclosing Party must explain below:

N/A

If the letters "NA," the word "None," or no response appears on the lines above, it will be conclusively presumed that the Disclosing Party certified to the above statements.

12. To the best of the Disclosing Party's knowledge after reasonable inquiry, the following is a complete list of all current employees of the Disclosing Party who were, at any time during the 12-month period preceding the date of this EDS, an employee, or elected or appointed official, of the City of Chicago (if none, indicate with "N/A" or "none").

N/A

13. To the best of the Disclosing Party's knowledge after reasonable inquiry, the following is a complete list of all gifts that the Disclosing Party has given or caused to be given, at any time during the 12-month period preceding the execution date of this EDS, to an employee, or elected or appointed official, of the City of Chicago. For purposes of this statement, a "gift" does not include: (i) anything made generally available to City employees or to the general public, or (ii) food or drink provided in the course of official City business and having a retail value of less than \$25 per recipient, or (iii) a political contribution otherwise duly reported as required by law (if none, indicate with "N/A" or "none"). As to any gift listed below, please also list the name of the City recipient.

N/A

C. CERTIFICATION OF STATUS AS FINANCIAL INSTITUTION

1. The Disclosing Party certifies that the Disclosing Party (check one)

is is not

a "financial institution" as defined in MCC Section 2-32-455(b).

2. If the Disclosing Party IS a financial institution, then the Disclosing Party pledges:

"We are not and will not become a predatory lender as defined in MCC Chapter 2-32. We further pledge that none of our affiliates is, and none of them will become, a predatory lender as defined in MCC Chapter 2-32. We understand that becoming a predatory lender or becoming an affiliate of a predatory lender may result in the loss of the privilege of doing business with the City."

If the Disclosing Party is unable to make this pledge because it or any of its affiliates (as defined in MCC Section 2-32-455(b)) is a predatory lender within the meaning of MCC Chapter 2-32, explain here (attach additional pages if necessary):

N/A

If the letters "NA," the word "None," or no response appears on the lines above, it will be conclusively presumed that the Disclosing Party certified to the above statements.

D. CERTIFICATION REGARDING FINANCIAL INTEREST IN CITY BUSINESS

Any words or terms defined in MCC Chapter 2-156 have the same meanings if used in this Part D.

1. In accordance with MCC Section 2-156-110: To the best of the Disclosing Party's knowledge after reasonable inquiry, does any official or employee of the City have a financial interest in his or her own name or in the name of any other person or entity in the Matter?

Yes

No

NOTE: If you checked "Yes" to Item D(1), proceed to Items D(2) and D(3). If you checked "No" to Item D(1), skip Items D(2) and D(3) and proceed to Part E.

2. Unless sold pursuant to a process of competitive bidding, or otherwise permitted, no City elected official or employee shall have a financial interest in his or her own name or in the name of any other person or entity in the purchase of any property that (i) belongs to the City, or (ii) is sold for taxes or assessments, or (iii) is sold by virtue of legal process at the suit of the City (collectively, "City Property Sale"). Compensation for property taken pursuant to the City's eminent domain power does not constitute a financial interest within the meaning of this Part D.

Does the Matter involve a City Property Sale?

Yes

No

3. If you checked "Yes" to Item D(1), provide the names and business addresses of the City officials or employees having such financial interest and identify the nature of the financial interest:

Name	Business Address	Nature of Financial Interest
<hr/>		
<hr/>		
<hr/>		

4. The Disclosing Party further certifies that no prohibited financial interest in the Matter will be acquired by any City official or employee.

E. CERTIFICATION REGARDING SLAVERY ERA BUSINESS

Please check either (1) or (2) below. If the Disclosing Party checks (2), the Disclosing Party must disclose below or in an attachment to this EDS all information required by (2). Failure to comply with these disclosure requirements may make any contract entered into with the City in connection with the Matter voidable by the City.

X 1. The Disclosing Party verifies that the Disclosing Party has searched any and all records of the Disclosing Party and any and all predecessor entities regarding records of investments or profits from slavery or slaveholder insurance policies during the slavery era (including insurance policies issued to slaveholders that provided coverage for damage to or injury or death of their slaves), and the Disclosing Party has found no such records.

___ 2. The Disclosing Party verifies that, as a result of conducting the search in step (1) above, the Disclosing Party has found records of investments or profits from slavery or slaveholder insurance policies. The Disclosing Party verifies that the following constitutes full disclosure of all such records, including the names of any and all slaves or slaveholders described in those records:

SECTION VI -- CERTIFICATIONS FOR FEDERALLY FUNDED MATTERS

NOTE: If the Matter is federally funded, complete this Section VI. If the Matter is not federally funded, proceed to Section VII. For purposes of this Section VI, tax credits allocated by the City and proceeds of debt obligations of the City are not federal funding.

A. CERTIFICATION REGARDING LOBBYING

1. List below the names of all persons or entities registered under the federal Lobbying Disclosure Act of 1995, as amended, who have made lobbying contacts on behalf of the Disclosing Party with respect to the Matter: (Add sheets if necessary):

(If no explanation appears or begins on the lines above, or if the letters "NA" or if the word "None" appear, it will be conclusively presumed that the Disclosing Party means that NO persons or entities registered under the Lobbying Disclosure Act of 1995, as amended, have made lobbying contacts on behalf of the Disclosing Party with respect to the Matter.)

2. The Disclosing Party has not spent and will not expend any federally appropriated funds to pay any person or entity listed in paragraph A(1) above for his or her lobbying activities or to pay any person or entity to influence or attempt to influence an officer or employee of any agency, as defined by applicable federal law, a member of Congress, an officer or employee of Congress, or an employee

of a member of Congress, in connection with the award of any federally funded contract, making any federally funded grant or loan, entering into any cooperative agreement, or to extend, continue, renew, amend, or modify any federally funded contract, grant, loan, or cooperative agreement.

3. The Disclosing Party will submit an updated certification at the end of each calendar quarter in which there occurs any event that materially affects the accuracy of the statements and information set forth in paragraphs A(1) and A(2) above.

4. The Disclosing Party certifies that either: (i) it is not an organization described in section 501(c)(4) of the Internal Revenue Code of 1986; or (ii) it is an organization described in section 501(c)(4) of the Internal Revenue Code of 1986 but has not engaged and will not engage in "Lobbying Activities," as that term is defined in the Lobbying Disclosure Act of 1995, as amended.

5. If the Disclosing Party is the Applicant, the Disclosing Party must obtain certifications equal in form and substance to paragraphs A(1) through A(4) above from all subcontractors before it awards any subcontract and the Disclosing Party must maintain all such subcontractors' certifications for the duration of the Matter and must make such certifications promptly available to the City upon request.

B. CERTIFICATION REGARDING EQUAL EMPLOYMENT OPPORTUNITY

If the Matter is federally funded, federal regulations require the Applicant and all proposed subcontractors to submit the following information with their bids or in writing at the outset of negotiations.

Is the Disclosing Party the Applicant?

Yes

No

If "Yes," answer the three questions below:

1. Have you developed and do you have on file affirmative action programs pursuant to applicable federal regulations? (See 41 CFR Part 60-2.)

Yes

No

2. Have you filed with the Joint Reporting Committee, the Director of the Office of Federal Contract Compliance Programs, or the Equal Employment Opportunity Commission all reports due under the applicable filing requirements?

Yes

No

Reports not required

3. Have you participated in any previous contracts or subcontracts subject to the equal opportunity clause?

Yes

No

If you checked "No" to question (1) or (2) above, please provide an explanation:

SECTION VII -- FURTHER ACKNOWLEDGMENTS AND CERTIFICATION

The Disclosing Party understands and agrees that:

- A. The certifications, disclosures, and acknowledgments contained in this EDS will become part of any contract or other agreement between the ^{Property Owner} Applicant and the City in connection with the Matter, whether procurement, City assistance, or other City action, and are material inducements to the City's execution of any contract or taking other action with respect to the Matter. The Disclosing Party understands that it must comply with all statutes, ordinances, and regulations on which this EDS is based.
- B. The City's Governmental Ethics Ordinance, MCC Chapter 2-156, imposes certain duties and obligations on persons or entities seeking City contracts, work, business, or transactions. The full text of this ordinance and a training program is available on line at www.cityofchicago.org/Ethics, and may also be obtained from the City's Board of Ethics, 740 N. Sedgwick St., Suite 500, Chicago, IL 60610, (312) 744-9660. The Disclosing Party must comply fully with this ordinance.
- C. If the City determines that any information provided in this EDS is false, incomplete or inaccurate, any contract or other agreement in connection with which it is submitted may be rescinded or be void or voidable, and the City may pursue any remedies under the contract or agreement (if not rescinded or void), at law, or in equity, including terminating the Disclosing Party's participation in the Matter and/or declining to allow the Disclosing Party to participate in other City transactions. Remedies at law for a false statement of material fact may include incarceration and an award to the City of treble damages.
- D. It is the City's policy to make this document available to the public on its Internet site and/or upon request. Some or all of the information provided in, and appended to, this EDS may be made publicly available on the Internet, in response to a Freedom of Information Act request, or otherwise. By completing and signing this EDS, the Disclosing Party waives and releases any possible rights or claims which it may have against the City in connection with the public release of information contained in this EDS and also authorizes the City to verify the accuracy of any information submitted in this EDS.
- E. The information provided in this EDS must be kept current. In the event of changes, the Disclosing Party must supplement this EDS up to the time the City takes action on the Matter. If the Matter is a contract being handled by the City's Department of Procurement Services, the Disclosing Party must update this EDS as the contract requires. **NOTE:** With respect to Matters subject to MCC Chapter 1-23, Article I (imposing **PERMANENT INELIGIBILITY** for certain specified offenses), the information provided herein regarding eligibility must be kept current for a longer period, as required by MCC Chapter 1-23 and Section 2-154-020.

CERTIFICATION

Under penalty of perjury, the person signing below: (1) warrants that he/she is authorized to execute this EDS, and all applicable Appendices, on behalf of the Disclosing Party, and (2) warrants that all certifications and statements contained in this EDS, and all applicable Appendices, are true, accurate and complete as of the date furnished to the City.

Wanxiang America Real Estate Group, LLC

(Print or type exact legal name of Disclosing Party)

By: 
(Sign here)

Lawrence J. Krueger
(Print or type name of person signing)

Managing Director
(Print or type title of person signing)

Signed and sworn to before me on (date) 2/26/19,

at Cook County, Illinois (state).

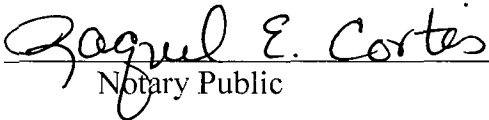
Notary Public



Commission expires: 4/30/22

OFFICIAL SEAL
RACHUEL S. CORTES
NOTARY PUBLIC - STATE OF ILLINOIS
MY COMMISSION EXPIRES: 03/31/2025

**CITY OF CHICAGO
ECONOMIC DISCLOSURE STATEMENT AND AFFIDAVIT
APPENDIX A**

**FAMILIAL RELATIONSHIPS WITH ELECTED CITY OFFICIALS
AND DEPARTMENT HEADS**

Property Owner

This Appendix is to be completed only by (a) the Applicant, and (b) any legal entity which has a direct ownership interest in the Applicant exceeding 7.5%. It is not to be completed by any legal entity which has only an indirect ownership interest in the Applicant.

Property Owner

Under MCC Section 2-154-015, the Disclosing Party must disclose whether such Disclosing Party or any "Applicable Party" or any Spouse or Domestic Partner thereof currently has a "familial relationship" with any elected city official or department head. A "familial relationship" exists if, as of the date this EDS is signed, the Disclosing Party or any "Applicable Party" or any Spouse or Domestic Partner thereof is related to the mayor, any alderman, the city clerk, the city treasurer or any city department head as spouse or domestic partner or as any of the following, whether by blood or adoption: parent, child, brother or sister, aunt or uncle, niece or nephew, grandparent, grandchild, father-in-law, mother-in-law, son-in-law, daughter-in-law, stepfather or stepmother, stepson or stepdaughter, stepbrother or stepsister or half-brother or half-sister.

"Applicable Party" means (1) all executive officers of the Disclosing Party listed in Section II.B.1.a., if the Disclosing Party is a corporation; all partners of the Disclosing Party, if the Disclosing Party is a general partnership; all general partners and limited partners of the Disclosing Party, if the Disclosing Party is a limited partnership; all managers, managing members and members of the Disclosing Party, if the Disclosing Party is a limited liability company; (2) all principal officers of the Disclosing Party; and (3) any person having more than a 7.5% ownership interest in the Disclosing Party. "Principal officers" means the president, chief operating officer, executive director, chief financial officer, treasurer or secretary of a legal entity or any person exercising similar authority.

Does the Disclosing Party or any "Applicable Party" or any Spouse or Domestic Partner thereof currently have a "familial relationship" with an elected city official or department head?

Yes

No

If yes, please identify below (1) the name and title of such person, (2) the name of the legal entity to which such person is connected; (3) the name and title of the elected city official or department head to whom such person has a familial relationship, and (4) the precise nature of such familial relationship.

**CITY OF CHICAGO
ECONOMIC DISCLOSURE STATEMENT AND AFFIDAVIT
APPENDIX B**

BUILDING CODE SCOFFLAW/PROBLEM LANDLORD CERTIFICATION

This Appendix is to be completed only by (a) the ^{Property Owner} ~~Applicant~~, and (b) any legal entity which has a direct ownership interest in the ^{Property Owner} ~~Applicant~~ exceeding 7.5% (an "Owner"). It is not to be completed by any legal entity which has only an indirect ownership interest in the ^{Property Owner} ~~Applicant~~.

1. Pursuant to MCC Section 2-154-010, is the ^{Property Owner} ~~Applicant~~ or any Owner identified as a building code scofflaw or problem landlord pursuant to MCC Section 2-92-416?

Yes No

2. If the ^{Property Owner} ~~Applicant~~ is a legal entity publicly traded on any exchange, is any officer or director of the ^{Property Owner} ~~Applicant~~ identified as a building code scofflaw or problem landlord pursuant to MCC Section 2-92-416?

Yes No The ^{Property Owner} ~~Applicant~~ is not publicly traded on any exchange.

3. If yes to (1) or (2) above, please identify below the name of each person or legal entity identified as a building code scofflaw or problem landlord and the address of each building or buildings to which the pertinent code violations apply.

**CITY OF CHICAGO
ECONOMIC DISCLOSURE STATEMENT AND AFFIDAVIT
APPENDIX C**

PROHIBITION ON WAGE & SALARY HISTORY SCREENING - CERTIFICATION

Property Owner

This Appendix is to be completed only by an ~~Applicant~~ that is completing this EDS as a “contractor” as defined in MCC Section 2-92-385. That section, which should be consulted (www.amlegal.com), generally covers a party to any agreement pursuant to which they: (i) receive City of Chicago funds in consideration for services, work or goods provided (including for legal or other professional services), or (ii) pay the City money for a license, grant or concession allowing them to conduct a business on City premises.

Property Owner

On behalf of an ~~Applicant~~ that is a contractor pursuant to MCC Section 2-92-385, I hereby certify that the ~~Applicant~~ is in compliance with MCC Section 2-92-385(b)(1) and (2), which prohibit: (i) screening job applicants based on their wage or salary history, or (ii) seeking job applicants’ wage or salary history from current or former employers. I also certify that the ~~Applicant~~ has adopted a policy that includes those prohibitions.

Yes

No

Property Owner

N/A – I am not an ~~Applicant~~ that is a “contractor” as defined in MCC Section 2-92-385.

This certification shall serve as the affidavit required by MCC Section 2-92-385(c)(1).

If you checked “no” to the above, please explain.

**CITY OF CHICAGO
ECONOMIC DISCLOSURE STATEMENT
AND AFFIDAVIT**

SECTION I -- GENERAL INFORMATION

A. Legal name of the Disclosing Party submitting this EDS. Include d/b/a/ if applicable:

Wanxiang America Corporation

Check ONE of the following three boxes:

Indicate whether the Disclosing Party submitting this EDS is:

1. the Applicant

OR

2. a legal entity currently holding, or anticipated to hold within six months after City action on the contract, transaction or other undertaking to which this EDS pertains (referred to below as the "Matter"), a direct or indirect interest in excess of 7.5% in the Applicant. State the Applicant's legal name: 311 N. Morgan, LLC ~~Property Owner~~ ~~Property Owner~~

OR

3. a legal entity with a direct or indirect right of control of the Applicant (see Section II(B)(1)) State the legal name of the entity in which the Disclosing Party holds a right of control:

B. Business address of the Disclosing Party: 88 Airport Road
Elgin, IL 60123

C. Telephone: 847-921-7064 Fax: 847-931-4339 Email: lkrueger@wanxiang.com

D. Name of contact person: Lawrence J. Krueger

E. Federal Employer Identification No. (if you have one): _____

F. Brief description of the Matter to which this EDS pertains. (Include project number and location of property, if applicable):

Application for planned development for property commonly known as 345 N. Morgan St., 311 N. Morgan St., and 1000 W. Carroll, Chicago, IL

G. Which City agency or department is requesting this EDS? DPD

If the Matter is a contract being handled by the City's Department of Procurement Services, please complete the following:

Specification # N/A and Contract # N/A

SECTION II -- DISCLOSURE OF OWNERSHIP INTERESTS

A. NATURE OF THE DISCLOSING PARTY

1. Indicate the nature of the Disclosing Party:

- Person
 - Publicly registered business corporation
 - Privately held business corporation
 - Sole proprietorship
 - General partnership
 - Limited partnership
 - Trust
 - Limited liability company
 - Limited liability partnership
 - Joint venture
 - Not-for-profit corporation
- (Is the not-for-profit corporation also a 501(c)(3))?
 Yes No
 Other (please specify)

2. For legal entities, the state (or foreign country) of incorporation or organization, if applicable:

Kentucky

3. For legal entities not organized in the State of Illinois: Has the organization registered to do business in the State of Illinois as a foreign entity?

- Yes
- No
- Organized in Illinois

B. IF THE DISCLOSING PARTY IS A LEGAL ENTITY:

1. List below the full names and titles, if applicable, of: (i) all executive officers and all directors of the entity; (ii) **for not-for-profit corporations**, all members, if any, which are legal entities (if there are no such members, write "no members which are legal entities"); (iii) **for trusts, estates or other similar entities**, the trustee, executor, administrator, or similarly situated party; (iv) **for general or limited partnerships, limited liability companies, limited liability partnerships or joint ventures**, each general partner, managing member, manager or any other person or legal entity that directly or indirectly controls the day-to-day management of the ~~Applicant~~ **Property Owner**.

NOTE: Each legal entity listed below must submit an EDS on its own behalf.

Name	Title
Pin Ni	President/Director
Gary Wetzal	Secretary/Director
Weiding Lu	Chairman/Director

2. Please provide the following information concerning each person or legal entity having a direct or indirect, current or prospective (i.e. within 6 months after City action) beneficial interest (including ownership) in excess of 7.5% of the ~~Applicant~~ **Property Owner**. Examples of such an interest include shares in a corporation, partnership interest in a partnership or joint venture, interest of a member or manager in a

limited liability company, or interest of a beneficiary of a trust, estate or other similar entity. If none, state "None."

NOTE: Each legal entity listed below may be required to submit an EDS on its own behalf.

Name	Business Address	Percentage Interest in the	Property Owner Applicant
See attached Exhibit A			

SECTION III -- INCOME OR COMPENSATION TO, OR OWNERSHIP BY, CITY ELECTED OFFICIALS

Has the Disclosing Party provided any income or compensation to any City elected official during the 12-month period preceding the date of this EDS? Yes No

Does the Disclosing Party reasonably expect to provide any income or compensation to any City elected official during the 12-month period following the date of this EDS? Yes No

If "yes" to either of the above, please identify below the name(s) of such City elected official(s) and describe such income or compensation:

Does any City elected official or, to the best of the Disclosing Party's knowledge after reasonable inquiry, any City elected official's spouse or domestic partner, have a financial interest (as defined in Chapter 2-156 of the Municipal Code of Chicago ("MCC")) in the Disclosing Party?

Yes No

If "yes," please identify below the name(s) of such City elected official(s) and/or spouse(s)/domestic partner(s) and describe the financial interest(s).

SECTION IV -- DISCLOSURE OF SUBCONTRACTORS AND OTHER RETAINED PARTIES

The Disclosing Party must disclose the name and business address of each subcontractor, attorney, lobbyist (as defined in MCC Chapter 2-156), accountant, consultant and any other person or entity whom the Disclosing Party has retained or expects to retain in connection with the Matter, as well as the nature of the relationship, and the total amount of the fees paid or estimated to be paid. The Disclosing Party is not required to disclose employees who are paid solely through the Disclosing Party's regular payroll. If the Disclosing Party is uncertain whether a disclosure is required under this Section, the Disclosing Party must either ask the City whether disclosure is required or make the disclosure.

Exhibit A
311 N. MORGAN ORGANIZATIONAL CHART
 "Property Owner"

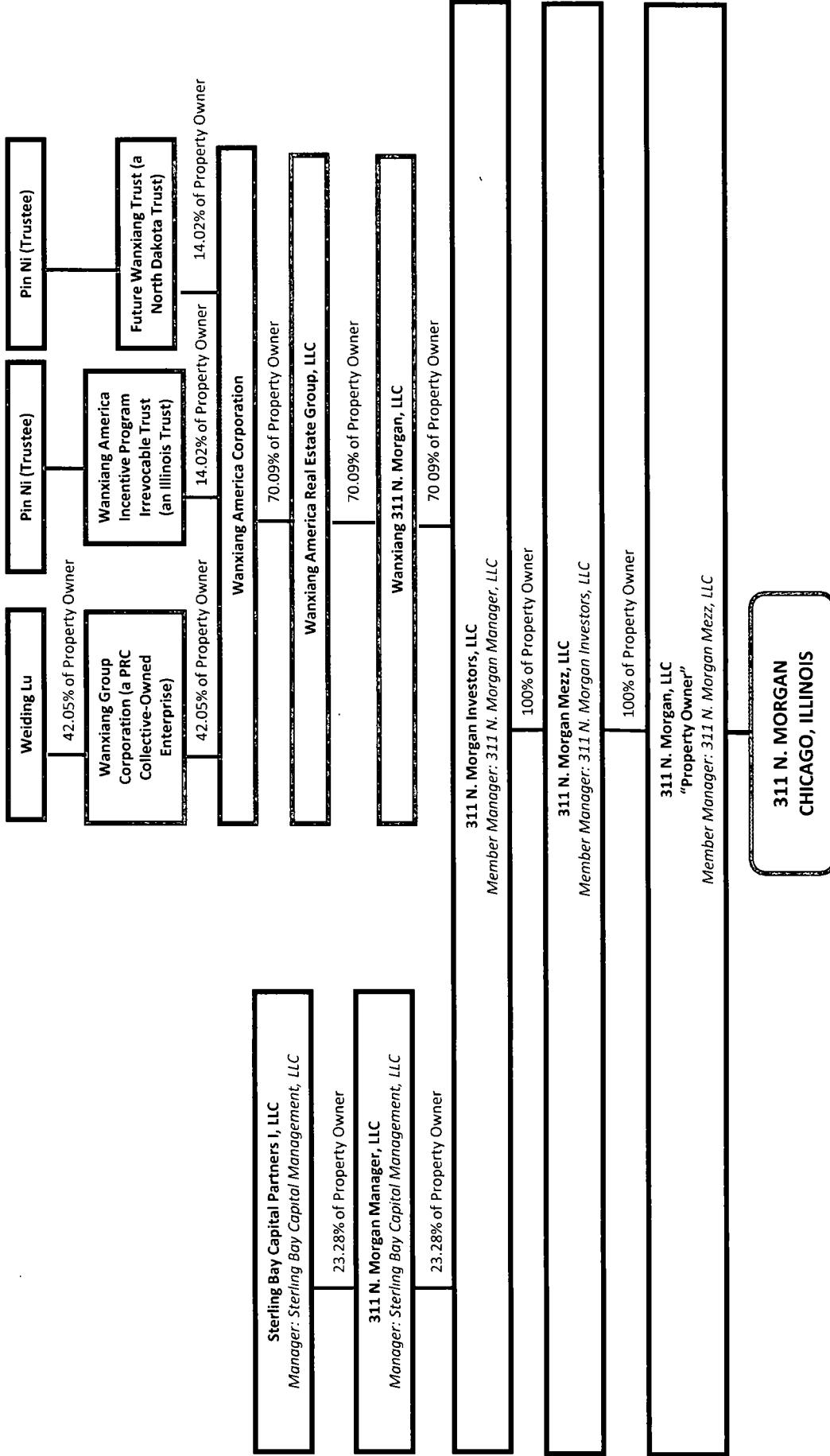

*All entities in blue have a business address of 1330 W. Fulton Street, Suite 800, Chicago, IL 60607; Wanxiang America Real Estate Group, LLC has a business address of 150 N. Riverside Plaza, Suite 1810, Chicago, IL 60606; Wanxiang 311 N. Morgan, LLC and Wanxiang America Corporation each have a business address of 88 Airport Rd., Elgin, IL 60123; Wanxiang Group Corporation, Wanxiang America Incentive Program Irrevocable Trust, and Future Wanxiang Trust each have a business address of Xiaoshan Economic and Technological Development Zone, Hanzhou, Zhejiang Province, The People's Republic of China

Name (indicate whether retained or anticipated to be retained)	Business Address	Relationship to Disclosing Party (subcontractor, attorney, lobbyist, etc.)	Fees (indicate whether paid or estimated.) NOTE: "hourly rate" or "t.b.d." is not an acceptable response.
--	------------------	--	--

(Add sheets if necessary)

Check here if the Disclosing Party has not retained, nor expects to retain, any such persons or entities.

SECTION V -- CERTIFICATIONS

A. COURT-ORDERED CHILD SUPPORT COMPLIANCE

Under MCC Section 2-92-415, substantial owners of business entities that contract with the City must remain in compliance with their child support obligations throughout the contract's term.

Has any person who directly or indirectly owns 10% or more of the Disclosing Party been declared in arrearage on any child support obligations by any Illinois court of competent jurisdiction?

Yes No No person directly or indirectly owns 10% or more of the Disclosing Party.

If "Yes," has the person entered into a court-approved agreement for payment of all support owed and is the person in compliance with that agreement?

Yes No

B. FURTHER CERTIFICATIONS

1. [This paragraph 1 applies only if the Matter is a contract being handled by the City's Department of Procurement Services.] In the 5-year period preceding the date of this EDS, neither the Disclosing Party nor any Affiliated Entity [see definition in (5) below] has engaged, in connection with the performance of any public contract, the services of an integrity monitor, independent private sector inspector general, or integrity compliance consultant (i.e., an individual or entity with legal, auditing, investigative, or other similar skills, designated by a public agency to help the agency monitor the activity of specified agency vendors as well as help the vendors reform their business practices so they can be considered for agency contracts in the future, or continue with a contract in progress).

2. The Disclosing Party and its Affiliated Entities are not delinquent in the payment of any fine, fee, tax or other source of indebtedness owed to the City of Chicago, including, but not limited to, water and sewer charges, license fees, parking tickets, property taxes and sales taxes, nor is the Disclosing Party delinquent in the payment of any tax administered by the Illinois Department of Revenue.

3. The Disclosing Party and, if the Disclosing Party is a legal entity, all of those persons or entities identified in Section II(B)(1) of this EDS:

- a. are not presently debarred, suspended, proposed for debarment, declared ineligible or voluntarily excluded from any transactions by any federal, state or local unit of government;
- b. have not, during the 5 years before the date of this EDS, been convicted of a criminal offense, adjudged guilty, or had a civil judgment rendered against them in connection with: obtaining, attempting to obtain, or performing a public (federal, state or local) transaction or contract under a public transaction; a violation of federal or state antitrust statutes; fraud; embezzlement; theft; forgery; bribery; falsification or destruction of records; making false statements; or receiving stolen property;
- c. are not presently indicted for, or criminally or civilly charged by, a governmental entity (federal, state or local) with committing any of the offenses set forth in subparagraph (b) above;
- d. have not, during the 5 years before the date of this EDS, had one or more public transactions (federal, state or local) terminated for cause or default; and
- e. have not, during the 5 years before the date of this EDS, been convicted, adjudged guilty, or found liable in a civil proceeding, or in any criminal or civil action, including actions concerning environmental violations, instituted by the City or by the federal government, any state, or any other unit of local government.

4. The Disclosing Party understands and shall comply with the applicable requirements of MCC Chapters 2-56 (Inspector General) and 2-156 (Governmental Ethics).

5. Certifications (5), (6) and (7) concern:

- the Disclosing Party;
- any "Contractor" (meaning any contractor or subcontractor used by the Disclosing Party in connection with the Matter, including but not limited to all persons or legal entities disclosed under Section IV, "Disclosure of Subcontractors and Other Retained Parties");
- any "Affiliated Entity" (meaning a person or entity that, directly or indirectly: controls the Disclosing Party, is controlled by the Disclosing Party, or is, with the Disclosing Party, under common control of another person or entity). Indicia of control include, without limitation: interlocking management or ownership; identity of interests among family members, shared facilities and equipment; common use of employees; or organization of a business entity following the ineligibility of a business entity to do business with federal or state or local government, including the City, using substantially the same management, ownership, or principals as the ineligible entity. With respect to Contractors, the term Affiliated Entity means a person or entity that directly or indirectly controls the Contractor, is controlled by it, or, with the Contractor, is under common control of another person or entity;
- any responsible official of the Disclosing Party, any Contractor or any Affiliated Entity or any other official, agent or employee of the Disclosing Party, any Contractor or any Affiliated Entity, acting pursuant to the direction or authorization of a responsible official of the Disclosing Party, any Contractor or any Affiliated Entity (collectively "Agents").

Neither the Disclosing Party, nor any Contractor, nor any Affiliated Entity of either the Disclosing Party or any Contractor, nor any Agents have, during the 5 years before the date of this EDS, or, with respect to a Contractor, an Affiliated Entity, or an Affiliated Entity of a Contractor during the 5 years before the date of such Contractor's or Affiliated Entity's contract or engagement in connection with the Matter:

- a. bribed or attempted to bribe, or been convicted or adjudged guilty of bribery or attempting to bribe, a public officer or employee of the City, the State of Illinois, or any agency of the federal government or of any state or local government in the United States of America, in that officer's or employee's official capacity;
 - b. agreed or colluded with other bidders or prospective bidders, or been a party to any such agreement, or been convicted or adjudged guilty of agreement or collusion among bidders or prospective bidders, in restraint of freedom of competition by agreement to bid a fixed price or otherwise; or
 - c. made an admission of such conduct described in subparagraph (a) or (b) above that is a matter of record, but have not been prosecuted for such conduct; or
 - d. violated the provisions referenced in MCC Subsection 2-92-320(a)(4)(Contracts Requiring a Base Wage); (a)(5)(Debarment Regulations); or (a)(6)(Minimum Wage Ordinance).
6. Neither the Disclosing Party, nor any Affiliated Entity or Contractor, or any of their employees, officials, agents or partners, is barred from contracting with any unit of state or local government as a result of engaging in or being convicted of (1) bid-rigging in violation of 720 ILCS 5/33E-3; (2) bid-rotating in violation of 720 ILCS 5/33E-4; or (3) any similar offense of any state or of the United States of America that contains the same elements as the offense of bid-rigging or bid-rotating.
7. Neither the Disclosing Party nor any Affiliated Entity is listed on a Sanctions List maintained by the United States Department of Commerce, State, or Treasury, or any successor federal agency.
8. [FOR APPLICANT ONLY] (i) Neither the Applicant nor any "controlling person" [see MCC Chapter 1-23, Article I for applicability and defined terms] of the Applicant is currently indicted or charged with, or has admitted guilt of, or has ever been convicted of, or placed under supervision for, any criminal offense involving actual, attempted, or conspiracy to commit bribery, theft, fraud, forgery, perjury, dishonesty or deceit against an officer or employee of the City or any "sister agency"; and (ii) the Applicant understands and acknowledges that compliance with Article I is a continuing requirement for doing business with the City. NOTE: If MCC Chapter 1-23, Article I applies to the Applicant, that Article's permanent compliance timeframe supersedes 5-year compliance timeframes in this Section V.
9. [FOR APPLICANT ONLY] The Applicant and its Affiliated Entities will not use, nor permit their subcontractors to use, any facility listed as having an active exclusion by the U.S. EPA on the federal System for Award Management ("SAM").
10. [FOR APPLICANT ONLY] The Applicant will obtain from any contractors/subcontractors hired or to be hired in connection with the Matter certifications equal in form and substance to those in Certifications (2) and (9) above and will not, without the prior written consent of the City, use any such

contractor/subcontractor that does not provide such certifications or that the Applicant has reason to believe has not provided or cannot provide truthful certifications.

11. If the Disclosing Party is unable to certify to any of the above statements in this Part B (Further Certifications), the Disclosing Party must explain below:

N/A

If the letters "NA," the word "None," or no response appears on the lines above, it will be conclusively presumed that the Disclosing Party certified to the above statements.

12. To the best of the Disclosing Party's knowledge after reasonable inquiry, the following is a complete list of all current employees of the Disclosing Party who were, at any time during the 12-month period preceding the date of this EDS, an employee, or elected or appointed official, of the City of Chicago (if none, indicate with "N/A" or "none").

N/A

13. To the best of the Disclosing Party's knowledge after reasonable inquiry, the following is a complete list of all gifts that the Disclosing Party has given or caused to be given, at any time during the 12-month period preceding the execution date of this EDS, to an employee, or elected or appointed official, of the City of Chicago. For purposes of this statement, a "gift" does not include: (i) anything made generally available to City employees or to the general public, or (ii) food or drink provided in the course of official City business and having a retail value of less than \$25 per recipient, or (iii) a political contribution otherwise duly reported as required by law (if none, indicate with "N/A" or "none"). As to any gift listed below, please also list the name of the City recipient.

N/A

C. CERTIFICATION OF STATUS AS FINANCIAL INSTITUTION

1. The Disclosing Party certifies that the Disclosing Party (check one)

is is not

a "financial institution" as defined in MCC Section 2-32-455(b).

2. If the Disclosing Party IS a financial institution, then the Disclosing Party pledges:

"We are not and will not become a predatory lender as defined in MCC Chapter 2-32. We further pledge that none of our affiliates is, and none of them will become, a predatory lender as defined in MCC Chapter 2-32. We understand that becoming a predatory lender or becoming an affiliate of a predatory lender may result in the loss of the privilege of doing business with the City."

If the Disclosing Party is unable to make this pledge because it or any of its affiliates (as defined in MCC Section 2-32-455(b)) is a predatory lender within the meaning of MCC Chapter 2-32, explain here (attach additional pages if necessary):

N/A

If the letters "NA," the word "None," or no response appears on the lines above, it will be conclusively presumed that the Disclosing Party certified to the above statements.

D. CERTIFICATION REGARDING FINANCIAL INTEREST IN CITY BUSINESS

Any words or terms defined in MCC Chapter 2-156 have the same meanings if used in this Part D.

1. In accordance with MCC Section 2-156-110: To the best of the Disclosing Party's knowledge after reasonable inquiry, does any official or employee of the City have a financial interest in his or her own name or in the name of any other person or entity in the Matter?

Yes No

NOTE: If you checked "Yes" to Item D(1), proceed to Items D(2) and D(3). If you checked "No" to Item D(1), skip Items D(2) and D(3) and proceed to Part E.

2. Unless sold pursuant to a process of competitive bidding, or otherwise permitted, no City elected official or employee shall have a financial interest in his or her own name or in the name of any other person or entity in the purchase of any property that (i) belongs to the City, or (ii) is sold for taxes or assessments, or (iii) is sold by virtue of legal process at the suit of the City (collectively, "City Property Sale"). Compensation for property taken pursuant to the City's eminent domain power does not constitute a financial interest within the meaning of this Part D.

Does the Matter involve a City Property Sale?

Yes No

3. If you checked "Yes" to Item D(1), provide the names and business addresses of the City officials or employees having such financial interest and identify the nature of the financial interest:

Name	Business Address	Nature of Financial Interest

4. The Disclosing Party further certifies that no prohibited financial interest in the Matter will be acquired by any City official or employee.

E. CERTIFICATION REGARDING SLAVERY ERA BUSINESS

Please check either (1) or (2) below. If the Disclosing Party checks (2), the Disclosing Party must disclose below or in an attachment to this EDS all information required by (2). Failure to comply with these disclosure requirements may make any contract entered into with the City in connection with the Matter voidable by the City.

X 1. The Disclosing Party verifies that the Disclosing Party has searched any and all records of the Disclosing Party and any and all predecessor entities regarding records of investments or profits from slavery or slaveholder insurance policies during the slavery era (including insurance policies issued to slaveholders that provided coverage for damage to or injury or death of their slaves), and the Disclosing Party has found no such records.

 2. The Disclosing Party verifies that, as a result of conducting the search in step (1) above, the Disclosing Party has found records of investments or profits from slavery or slaveholder insurance policies. The Disclosing Party verifies that the following constitutes full disclosure of all such records, including the names of any and all slaves or slaveholders described in those records:

SECTION VI -- CERTIFICATIONS FOR FEDERALLY FUNDED MATTERS

NOTE: If the Matter is federally funded, complete this Section VI. **If the Matter is not federally funded**, proceed to Section VII. For purposes of this Section VI, tax credits allocated by the City and proceeds of debt obligations of the City are not federal funding.

A. CERTIFICATION REGARDING LOBBYING

1. List below the names of all persons or entities registered under the federal Lobbying Disclosure Act of 1995, as amended, who have made lobbying contacts on behalf of the Disclosing Party with respect to the Matter: (Add sheets if necessary):

(If no explanation appears or begins on the lines above, or if the letters "NA" or if the word "None" appear, it will be conclusively presumed that the Disclosing Party means that NO persons or entities registered under the Lobbying Disclosure Act of 1995, as amended, have made lobbying contacts on behalf of the Disclosing Party with respect to the Matter.)

2. The Disclosing Party has not spent and will not expend any federally appropriated funds to pay any person or entity listed in paragraph A(1) above for his or her lobbying activities or to pay any person or entity to influence or attempt to influence an officer or employee of any agency, as defined by applicable federal law, a member of Congress, an officer or employee of Congress, or an employee

of a member of Congress, in connection with the award of any federally funded contract, making any federally funded grant or loan, entering into any cooperative agreement, or to extend, continue, renew, amend, or modify any federally funded contract, grant, loan, or cooperative agreement.

3. The Disclosing Party will submit an updated certification at the end of each calendar quarter in which there occurs any event that materially affects the accuracy of the statements and information set forth in paragraphs A(1) and A(2) above.

4. The Disclosing Party certifies that either: (i) it is not an organization described in section 501(c)(4) of the Internal Revenue Code of 1986; or (ii) it is an organization described in section 501(c)(4) of the Internal Revenue Code of 1986 but has not engaged and will not engage in "Lobbying Activities," as that term is defined in the Lobbying Disclosure Act of 1995, as amended.

5. If the Disclosing Party is the Applicant, the Disclosing Party must obtain certifications equal in form and substance to paragraphs A(1) through A(4) above from all subcontractors before it awards any subcontract and the Disclosing Party must maintain all such subcontractors' certifications for the duration of the Matter and must make such certifications promptly available to the City upon request.

B. CERTIFICATION REGARDING EQUAL EMPLOYMENT OPPORTUNITY

If the Matter is federally funded, federal regulations require the Applicant and all proposed subcontractors to submit the following information with their bids or in writing at the outset of negotiations.

Is the Disclosing Party the Applicant?

Yes No

If "Yes," answer the three questions below:

1. Have you developed and do you have on file affirmative action programs pursuant to applicable federal regulations? (See 41 CFR Part 60-2.)

Yes No

2. Have you filed with the Joint Reporting Committee, the Director of the Office of Federal Contract Compliance Programs, or the Equal Employment Opportunity Commission all reports due under the applicable filing requirements?

Yes No Reports not required

3. Have you participated in any previous contracts or subcontracts subject to the equal opportunity clause?

Yes No

If you checked "No" to question (1) or (2) above, please provide an explanation:

SECTION VII -- FURTHER ACKNOWLEDGMENTS AND CERTIFICATION

The Disclosing Party understands and agrees that:

A. The certifications, disclosures, and acknowledgments contained in this EDS will become part of any contract or other agreement between the ^{Property Owner} Applicant and the City in connection with the Matter, whether procurement, City assistance, or other City action, and are material inducements to the City's execution of any contract or taking other action with respect to the Matter. The Disclosing Party understands that it must comply with all statutes, ordinances, and regulations on which this EDS is based.

B. The City's Governmental Ethics Ordinance, MCC Chapter 2-156, imposes certain duties and obligations on persons or entities seeking City contracts, work, business, or transactions. The full text of this ordinance and a training program is available on line at www.cityofchicago.org/Ethics, and may also be obtained from the City's Board of Ethics, 740 N. Sedgwick St., Suite 500, Chicago, IL 60610, (312) 744-9660. The Disclosing Party must comply fully with this ordinance.

C. If the City determines that any information provided in this EDS is false, incomplete or inaccurate, any contract or other agreement in connection with which it is submitted may be rescinded or be void or voidable, and the City may pursue any remedies under the contract or agreement (if not rescinded or void), at law, or in equity, including terminating the Disclosing Party's participation in the Matter and/or declining to allow the Disclosing Party to participate in other City transactions. Remedies at law for a false statement of material fact may include incarceration and an award to the City of treble damages.

D. It is the City's policy to make this document available to the public on its Internet site and/or upon request. Some or all of the information provided in, and appended to, this EDS may be made publicly available on the Internet, in response to a Freedom of Information Act request, or otherwise. By completing and signing this EDS, the Disclosing Party waives and releases any possible rights or claims which it may have against the City in connection with the public release of information contained in this EDS and also authorizes the City to verify the accuracy of any information submitted in this EDS.

E. The information provided in this EDS must be kept current. In the event of changes, the Disclosing Party must supplement this EDS up to the time the City takes action on the Matter. If the Matter is a contract being handled by the City's Department of Procurement Services, the Disclosing Party must update this EDS as the contract requires. **NOTE:** With respect to Matters subject to MCC Chapter 1-23, Article I (imposing **PERMANENT INELIGIBILITY** for certain specified offenses), the information provided herein regarding eligibility must be kept current for a longer period, as required by MCC Chapter 1-23 and Section 2-154-020.

CERTIFICATION

Under penalty of perjury, the person signing below: (1) warrants that he/she is authorized to execute this EDS, and all applicable Appendices, on behalf of the Disclosing Party, and (2) warrants that all certifications and statements contained in this EDS, and all applicable Appendices, are true, accurate and complete as of the date furnished to the City.

Wanxiang America Corporation

(Print or type exact legal name of Disclosing Party)

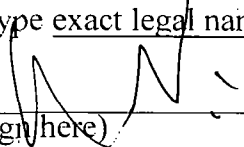
By: 
(Sign here)

Pin Ni
(Print or type name of person signing)

Authorized Signatory
(Print or type title of person signing)

Signed and sworn to before me on (date) 2/26/19,

at COOK County, Illinois (state).

Raquel E. Cortes
Notary Public



Commission expires: 4/30/22

OFFICIAL SEAL
RACHEL E. CORTES
NOTARY PUBLIC - STATE OF ILLINOIS
MY COMMISSION EXPIRES 04/03/25

**CITY OF CHICAGO
ECONOMIC DISCLOSURE STATEMENT AND AFFIDAVIT
APPENDIX A**

**FAMILIAL RELATIONSHIPS WITH ELECTED CITY OFFICIALS
AND DEPARTMENT HEADS**

Property Owner

This Appendix is to be completed only by (a) the Applicant, and (b) any legal entity which has a direct ownership interest in the Applicant exceeding 7.5%. It is not to be completed by any legal entity which has only an indirect ownership interest in the Applicant.

Property Owner

Under MCC Section 2-154-015, the Disclosing Party must disclose whether such Disclosing Party or any "Applicable Party" or any Spouse or Domestic Partner thereof currently has a "familial relationship" with any elected city official or department head. A "familial relationship" exists if, as of the date this EDS is signed, the Disclosing Party or any "Applicable Party" or any Spouse or Domestic Partner thereof is related to the mayor, any alderman, the city clerk, the city treasurer or any city department head as spouse or domestic partner or as any of the following, whether by blood or adoption: parent, child, brother or sister, aunt or uncle, niece or nephew, grandparent, grandchild, father-in-law, mother-in-law, son-in-law, daughter-in-law, stepfather or stepmother, stepson or stepdaughter, stepbrother or stepsister or half-brother or half-sister.

"Applicable Party" means (1) all executive officers of the Disclosing Party listed in Section II.B.1.a., if the Disclosing Party is a corporation; all partners of the Disclosing Party, if the Disclosing Party is a general partnership; all general partners and limited partners of the Disclosing Party, if the Disclosing Party is a limited partnership; all managers, managing members and members of the Disclosing Party, if the Disclosing Party is a limited liability company; (2) all principal officers of the Disclosing Party; and (3) any person having more than a 7.5% ownership interest in the Disclosing Party. "Principal officers" means the president, chief operating officer, executive director, chief financial officer, treasurer or secretary of a legal entity or any person exercising similar authority.

Does the Disclosing Party or any "Applicable Party" or any Spouse or Domestic Partner thereof currently have a "familial relationship" with an elected city official or department head?

Yes No

If yes, please identify below (1) the name and title of such person, (2) the name of the legal entity to which such person is connected; (3) the name and title of the elected city official or department head to whom such person has a familial relationship, and (4) the precise nature of such familial relationship.

**CITY OF CHICAGO
ECONOMIC DISCLOSURE STATEMENT AND AFFIDAVIT
APPENDIX B**

BUILDING CODE SCOFFLAW/PROBLEM LANDLORD CERTIFICATION

Property Owner

This Appendix is to be completed only by (a) the ~~Applicant~~^{Property Owner}, and (b) any legal entity which has a direct ownership interest in the ~~Applicant~~^{Property Owner} exceeding 7.5% (an "Owner"). It is not to be completed by any legal entity which has only an indirect ownership interest in the ~~Applicant~~^{Property Owner}.

1. Pursuant to MCC Section 2-154-010, is the ~~Applicant~~^{Property Owner} or any Owner identified as a building code scofflaw or problem landlord pursuant to MCC Section 2-92-416?

Yes No

2. If the ~~Applicant~~^{Property Owner} is a legal entity publicly traded on any exchange, is any officer or director of the ~~Applicant~~^{Property Owner} identified as a building code scofflaw or problem landlord pursuant to MCC Section 2-92-416?

Yes No The ~~Applicant~~^{Property Owner} is not publicly traded on any exchange.

3. If yes to (1) or (2) above, please identify below the name of each person or legal entity identified as a building code scofflaw or problem landlord and the address of each building or buildings to which the pertinent code violations apply.

**CITY OF CHICAGO
ECONOMIC DISCLOSURE STATEMENT AND AFFIDAVIT
APPENDIX C**

PROHIBITION ON WAGE & SALARY HISTORY SCREENING - CERTIFICATION

Property Owner

This Appendix is to be completed only by an ~~Applicant~~ that is completing this EDS as a “contractor” as defined in MCC Section 2-92-385. That section, which should be consulted (www.amlegal.com), generally covers a party to any agreement pursuant to which they: (i) receive City of Chicago funds in consideration for services, work or goods provided (including for legal or other professional services), or (ii) pay the City money for a license, grant or concession allowing them to conduct a business on City premises.

Property Owner

On behalf of an ~~Applicant~~ that is a contractor pursuant to MCC Section 2-92-385, I hereby certify that the ~~Applicant~~ is in compliance with MCC Section 2-92-385(b)(1) and (2), which prohibit: (i) screening job applicants based on their wage or salary history, or (ii) seeking job applicants’ wage or salary history from current or former employers. I also certify that the ~~Applicant~~ has adopted a policy that includes those prohibitions.

Yes

No

Property Owner

N/A – I am not an ~~Applicant~~ that is a “contractor” as defined in MCC Section 2-92-385.

This certification shall serve as the affidavit required by MCC Section 2-92-385(c)(1).

If you checked “no” to the above, please explain.

**CITY OF CHICAGO
ECONOMIC DISCLOSURE STATEMENT
AND AFFIDAVIT**

SECTION I -- GENERAL INFORMATION

A. Legal name of the Disclosing Party submitting this EDS. Include d/b/a/ if applicable:

Wanxiang Group Corporation (a PRC Collective-Owned Enterprise)

Check ONE of the following three boxes:

Indicate whether the Disclosing Party submitting this EDS is:

1. the Applicant
OR

2. a legal entity currently holding, or anticipated to hold within six months after City action on the contract, transaction or other undertaking to which this EDS pertains (referred to below as the "Matter"), a direct or indirect interest in excess of 7.5% in the Applicant. State the Applicant's legal name: 311 N. Morgan, LLC ~~Property Owner~~ ~~Property Owner~~
OR

3. a legal entity with a direct or indirect right of control of the Applicant (see Section II(B)(1))
State the legal name of the entity in which the Disclosing Party holds a right of control:

B. Business address of the Disclosing Party: Xiaoshan Economic and Technological Development Zone,
Hanzhou, Zhejiang Province, The People's Republic of China

C. Telephone: 847-921-7064 Fax: 847-931-4339 Email: _____

D. Name of contact person: Lawrence J. Krueger

E. Federal Employer Identification No. (if you have one): _____

F. Brief description of the Matter to which this EDS pertains. (Include project number and location of property, if applicable):

Application for planned development for property commonly known as 345 N. Morgan St., 311 N. Morgan St., and 1000 W. Carroll, Chicago, IL

G. Which City agency or department is requesting this EDS? DPD

If the Matter is a contract being handled by the City's Department of Procurement Services, please complete the following:

Specification # N/A and Contract # N/A

SECTION II -- DISCLOSURE OF OWNERSHIP INTERESTS

A. NATURE OF THE DISCLOSING PARTY

1. Indicate the nature of the Disclosing Party:

- Person
- Publicly registered business corporation
- Privately held business corporation
- Sole proprietorship
- General partnership
- Limited partnership
- Trust
- Limited liability company
- Limited liability partnership
- Joint venture
- Not-for-profit corporation
- (Is the not-for-profit corporation also a 501(c)(3))?
 Yes No
- Other (please specify)
Collective-Owned Enterprise of the People's Republic of China

2. For legal entities, the state (or foreign country) of incorporation or organization, if applicable:

People's Republic of China

3. For legal entities not organized in the State of Illinois: Has the organization registered to do business in the State of Illinois as a foreign entity?

- Yes
- No
- Organized in Illinois

B. IF THE DISCLOSING PARTY IS A LEGAL ENTITY:

1. List below the full names and titles, if applicable, of: (i) all executive officers and all directors of the entity; (ii) **for not-for-profit corporations**, all members, if any, which are legal entities (if there are no such members, write "no members which are legal entities"); (iii) **for trusts, estates or other similar entities**, the trustee, executor, administrator, or similarly situated party; (iv) **for general or limited partnerships, limited liability companies, limited liability partnerships or joint ventures**, each general partner, managing member, manager or any other person or legal entity that directly or indirectly controls the day-to-day management of the ~~Applicant~~
Property Owner

NOTE: Each legal entity listed below must submit an EDS on its own behalf.

Name	Title
Weiding Lu	Chairman
Pin Ni	Director

2. Please provide the following information concerning each person or legal entity having a direct or indirect, current or prospective (i.e. within 6 months after City action) beneficial interest (including ownership) in excess of 7.5% of the ~~Applicant~~
Property Owner. Examples of such an interest include shares in a corporation, partnership interest in a partnership or joint venture, interest of a member or manager in a

Name (indicate whether retained or anticipated to be retained)	Business Address	Relationship to Disclosing Party (subcontractor, attorney, lobbyist, etc.)	Fees (<u>indicate whether paid or estimated.</u>) NOTE: "hourly rate" or "t.b.d." is not an acceptable response.
--	------------------	--	---

(Add sheets if necessary)

Check here if the Disclosing Party has not retained, nor expects to retain, any such persons or entities.

SECTION V -- CERTIFICATIONS

A. COURT-ORDERED CHILD SUPPORT COMPLIANCE

Under MCC Section 2-92-415, substantial owners of business entities that contract with the City must remain in compliance with their child support obligations throughout the contract's term.

Has any person who directly or indirectly owns 10% or more of the Disclosing Party been declared in arrearage on any child support obligations by any Illinois court of competent jurisdiction?

Yes No No person directly or indirectly owns 10% or more of the Disclosing Party.

If "Yes," has the person entered into a court-approved agreement for payment of all support owed and is the person in compliance with that agreement?

Yes No

B. FURTHER CERTIFICATIONS

1. [This paragraph 1 applies only if the Matter is a contract being handled by the City's Department of Procurement Services.] In the 5-year period preceding the date of this EDS, neither the Disclosing Party nor any Affiliated Entity [see definition in (5) below] has engaged, in connection with the performance of any public contract, the services of an integrity monitor, independent private sector inspector general, or integrity compliance consultant (i.e., an individual or entity with legal, auditing, investigative, or other similar skills, designated by a public agency to help the agency monitor the activity of specified agency vendors as well as help the vendors reform their business practices so they can be considered for agency contracts in the future, or continue with a contract in progress).

2. The Disclosing Party and its Affiliated Entities are not delinquent in the payment of any fine, fee, tax or other source of indebtedness owed to the City of Chicago, including, but not limited to, water and sewer charges, license fees, parking tickets, property taxes and sales taxes, nor is the Disclosing Party delinquent in the payment of any tax administered by the Illinois Department of Revenue.

3. The Disclosing Party and, if the Disclosing Party is a legal entity, all of those persons or entities identified in Section II(B)(1) of this EDS:

- a. are not presently debarred, suspended, proposed for debarment, declared ineligible or voluntarily excluded from any transactions by any federal, state or local unit of government;
- b. have not, during the 5 years before the date of this EDS, been convicted of a criminal offense, adjudged guilty, or had a civil judgment rendered against them in connection with: obtaining, attempting to obtain, or performing a public (federal, state or local) transaction or contract under a public transaction; a violation of federal or state antitrust statutes; fraud; embezzlement; theft; forgery; bribery; falsification or destruction of records; making false statements; or receiving stolen property;
- c. are not presently indicted for, or criminally or civilly charged by, a governmental entity (federal, state or local) with committing any of the offenses set forth in subparagraph (b) above;
- d. have not, during the 5 years before the date of this EDS, had one or more public transactions (federal, state or local) terminated for cause or default; and
- e. have not, during the 5 years before the date of this EDS, been convicted, adjudged guilty, or found liable in a civil proceeding, or in any criminal or civil action, including actions concerning environmental violations, instituted by the City or by the federal government, any state, or any other unit of local government.

4. The Disclosing Party understands and shall comply with the applicable requirements of MCC Chapters 2-56 (Inspector General) and 2-156 (Governmental Ethics).

5. Certifications (5), (6) and (7) concern:

- the Disclosing Party;
- any "Contractor" (meaning any contractor or subcontractor used by the Disclosing Party in connection with the Matter, including but not limited to all persons or legal entities disclosed under Section IV, "Disclosure of Subcontractors and Other Retained Parties");
- any "Affiliated Entity" (meaning a person or entity that, directly or indirectly: controls the Disclosing Party, is controlled by the Disclosing Party, or is, with the Disclosing Party, under common control of another person or entity). Indicia of control include, without limitation: interlocking management or ownership; identity of interests among family members, shared facilities and equipment; common use of employees; or organization of a business entity following the ineligibility of a business entity to do business with federal or state or local government, including the City, using substantially the same management, ownership, or principals as the ineligible entity. With respect to Contractors, the term Affiliated Entity means a person or entity that directly or indirectly controls the Contractor, is controlled by it, or, with the Contractor, is under common control of another person or entity;
- any responsible official of the Disclosing Party, any Contractor or any Affiliated Entity or any other official, agent or employee of the Disclosing Party, any Contractor or any Affiliated Entity, acting pursuant to the direction or authorization of a responsible official of the Disclosing Party, any Contractor or any Affiliated Entity (collectively "Agents").

Neither the Disclosing Party, nor any Contractor, nor any Affiliated Entity of either the Disclosing Party or any Contractor, nor any Agents have, during the 5 years before the date of this EDS, or, with respect to a Contractor, an Affiliated Entity, or an Affiliated Entity of a Contractor during the 5 years before the date of such Contractor's or Affiliated Entity's contract or engagement in connection with the Matter:

- a. bribed or attempted to bribe, or been convicted or adjudged guilty of bribery or attempting to bribe, a public officer or employee of the City, the State of Illinois, or any agency of the federal government or of any state or local government in the United States of America, in that officer's or employee's official capacity;
- b. agreed or colluded with other bidders or prospective bidders, or been a party to any such agreement, or been convicted or adjudged guilty of agreement or collusion among bidders or prospective bidders, in restraint of freedom of competition by agreement to bid a fixed price or otherwise; or
- c. made an admission of such conduct described in subparagraph (a) or (b) above that is a matter of record, but have not been prosecuted for such conduct; or
- d. violated the provisions referenced in MCC Subsection 2-92-320(a)(4)(Contracts Requiring a Base Wage); (a)(5)(Debarment Regulations); or (a)(6)(Minimum Wage Ordinance).

6. Neither the Disclosing Party, nor any Affiliated Entity or Contractor, or any of their employees, officials, agents or partners, is barred from contracting with any unit of state or local government as a result of engaging in or being convicted of (1) bid-rigging in violation of 720 ILCS 5/33E-3; (2) bid-rotating in violation of 720 ILCS 5/33E-4; or (3) any similar offense of any state or of the United States of America that contains the same elements as the offense of bid-rigging or bid-rotating.

7. Neither the Disclosing Party nor any Affiliated Entity is listed on a Sanctions List maintained by the United States Department of Commerce, State, or Treasury, or any successor federal agency.

8. [FOR APPLICANT ONLY] (i) Neither the Applicant nor any "controlling person" [see MCC Chapter 1-23, Article I for applicability and defined terms] of the Applicant is currently indicted or charged with, or has admitted guilt of, or has ever been convicted of, or placed under supervision for, any criminal offense involving actual, attempted, or conspiracy to commit bribery, theft, fraud, forgery, perjury, dishonesty or deceit against an officer or employee of the City or any "sister agency"; and (ii) the Applicant understands and acknowledges that compliance with Article I is a continuing requirement for doing business with the City. NOTE: If MCC Chapter 1-23, Article I applies to the Applicant, that Article's permanent compliance timeframe supersedes 5-year compliance timeframes in this Section V.

9. [FOR APPLICANT ONLY] The Applicant and its Affiliated Entities will not use, nor permit their subcontractors to use, any facility listed as having an active exclusion by the U.S. EPA on the federal System for Award Management ("SAM").

10. [FOR APPLICANT ONLY] The Applicant will obtain from any contractors/subcontractors hired or to be hired in connection with the Matter certifications equal in form and substance to those in Certifications (2) and (9) above and will not, without the prior written consent of the City, use any such

contractor/subcontractor that does not provide such certifications or that the Applicant has reason to believe has not provided or cannot provide truthful certifications.

11. If the Disclosing Party is unable to certify to any of the above statements in this Part B (Further Certifications), the Disclosing Party must explain below:

N/A

If the letters "NA," the word "None," or no response appears on the lines above, it will be conclusively presumed that the Disclosing Party certified to the above statements.

12. To the best of the Disclosing Party's knowledge after reasonable inquiry, the following is a complete list of all current employees of the Disclosing Party who were, at any time during the 12-month period preceding the date of this EDS, an employee, or elected or appointed official, of the City of Chicago (if none, indicate with "N/A" or "none").

N/A

13. To the best of the Disclosing Party's knowledge after reasonable inquiry, the following is a complete list of all gifts that the Disclosing Party has given or caused to be given, at any time during the 12-month period preceding the execution date of this EDS, to an employee, or elected or appointed official, of the City of Chicago. For purposes of this statement, a "gift" does not include: (i) anything made generally available to City employees or to the general public, or (ii) food or drink provided in the course of official City business and having a retail value of less than \$25 per recipient, or (iii) a political contribution otherwise duly reported as required by law (if none, indicate with "N/A" or "none"). As to any gift listed below, please also list the name of the City recipient.

N/A

C. CERTIFICATION OF STATUS AS FINANCIAL INSTITUTION

1. The Disclosing Party certifies that the Disclosing Party (check one)

is is not

a "financial institution" as defined in MCC Section 2-32-455(b).

2. If the Disclosing Party IS a financial institution, then the Disclosing Party pledges:

"We are not and will not become a predatory lender as defined in MCC Chapter 2-32. We further pledge that none of our affiliates is, and none of them will become, a predatory lender as defined in MCC Chapter 2-32. We understand that becoming a predatory lender or becoming an affiliate of a predatory lender may result in the loss of the privilege of doing business with the City."

If the Disclosing Party is unable to make this pledge because it or any of its affiliates (as defined in MCC Section 2-32-455(b)) is a predatory lender within the meaning of MCC Chapter 2-32, explain here (attach additional pages if necessary):

N/A

If the letters "NA," the word "None," or no response appears on the lines above, it will be conclusively presumed that the Disclosing Party certified to the above statements.

D. CERTIFICATION REGARDING FINANCIAL INTEREST IN CITY BUSINESS

Any words or terms defined in MCC Chapter 2-156 have the same meanings if used in this Part D.

1. In accordance with MCC Section 2-156-110: To the best of the Disclosing Party's knowledge after reasonable inquiry, does any official or employee of the City have a financial interest in his or her own name or in the name of any other person or entity in the Matter?

Yes

No

NOTE: If you checked "Yes" to Item D(1), proceed to Items D(2) and D(3). If you checked "No" to Item D(1), skip Items D(2) and D(3) and proceed to Part E.

2. Unless sold pursuant to a process of competitive bidding, or otherwise permitted, no City elected official or employee shall have a financial interest in his or her own name or in the name of any other person or entity in the purchase of any property that (i) belongs to the City, or (ii) is sold for taxes or assessments, or (iii) is sold by virtue of legal process at the suit of the City (collectively, "City Property Sale"). Compensation for property taken pursuant to the City's eminent domain power does not constitute a financial interest within the meaning of this Part D.

Does the Matter involve a City Property Sale?

Yes

No

3. If you checked "Yes" to Item D(1), provide the names and business addresses of the City officials or employees having such financial interest and identify the nature of the financial interest:

Name

Business Address

Nature of Financial Interest

4. The Disclosing Party further certifies that no prohibited financial interest in the Matter will be acquired by any City official or employee.

E. CERTIFICATION REGARDING SLAVERY ERA BUSINESS

Please check either (1) or (2) below. If the Disclosing Party checks (2), the Disclosing Party must disclose below or in an attachment to this EDS all information required by (2). Failure to comply with these disclosure requirements may make any contract entered into with the City in connection with the Matter voidable by the City.

X 1. The Disclosing Party verifies that the Disclosing Party has searched any and all records of the Disclosing Party and any and all predecessor entities regarding records of investments or profits from slavery or slaveholder insurance policies during the slavery era (including insurance policies issued to slaveholders that provided coverage for damage to or injury or death of their slaves), and the Disclosing Party has found no such records.

2. The Disclosing Party verifies that, as a result of conducting the search in step (1) above, the Disclosing Party has found records of investments or profits from slavery or slaveholder insurance policies. The Disclosing Party verifies that the following constitutes full disclosure of all such records, including the names of any and all slaves or slaveholders described in those records:

SECTION VI -- CERTIFICATIONS FOR FEDERALLY FUNDED MATTERS

NOTE: If the Matter is federally funded, complete this Section VI. If the Matter is not federally funded, proceed to Section VII. For purposes of this Section VI, tax credits allocated by the City and proceeds of debt obligations of the City are not federal funding.

A. CERTIFICATION REGARDING LOBBYING

1. List below the names of all persons or entities registered under the federal Lobbying Disclosure Act of 1995, as amended, who have made lobbying contacts on behalf of the Disclosing Party with respect to the Matter: (Add sheets if necessary):

(If no explanation appears or begins on the lines above, or if the letters "NA" or if the word "None" appear, it will be conclusively presumed that the Disclosing Party means that NO persons or entities registered under the Lobbying Disclosure Act of 1995, as amended, have made lobbying contacts on behalf of the Disclosing Party with respect to the Matter.)

2. The Disclosing Party has not spent and will not expend any federally appropriated funds to pay any person or entity listed in paragraph A(1) above for his or her lobbying activities or to pay any person or entity to influence or attempt to influence an officer or employee of any agency, as defined by applicable federal law, a member of Congress, an officer or employee of Congress, or an employee

of a member of Congress, in connection with the award of any federally funded contract, making any federally funded grant or loan, entering into any cooperative agreement, or to extend, continue, renew, amend, or modify any federally funded contract, grant, loan, or cooperative agreement.

3. The Disclosing Party will submit an updated certification at the end of each calendar quarter in which there occurs any event that materially affects the accuracy of the statements and information set forth in paragraphs A(1) and A(2) above.

4. The Disclosing Party certifies that either: (i) it is not an organization described in section 501(c)(4) of the Internal Revenue Code of 1986; or (ii) it is an organization described in section 501(c)(4) of the Internal Revenue Code of 1986 but has not engaged and will not engage in "Lobbying Activities," as that term is defined in the Lobbying Disclosure Act of 1995, as amended.

5. If the Disclosing Party is the Applicant, the Disclosing Party must obtain certifications equal in form and substance to paragraphs A(1) through A(4) above from all subcontractors before it awards any subcontract and the Disclosing Party must maintain all such subcontractors' certifications for the duration of the Matter and must make such certifications promptly available to the City upon request.

B. CERTIFICATION REGARDING EQUAL EMPLOYMENT OPPORTUNITY

If the Matter is federally funded, federal regulations require the Applicant and all proposed subcontractors to submit the following information with their bids or in writing at the outset of negotiations.

Is the Disclosing Party the Applicant?

Yes

No

If "Yes," answer the three questions below:

1. Have you developed and do you have on file affirmative action programs pursuant to applicable federal regulations? (See 41 CFR Part 60-2.)

Yes

No

2. Have you filed with the Joint Reporting Committee, the Director of the Office of Federal Contract Compliance Programs, or the Equal Employment Opportunity Commission all reports due under the applicable filing requirements?

Yes

No

Reports not required

3. Have you participated in any previous contracts or subcontracts subject to the equal opportunity clause?

Yes

No

If you checked "No" to question (1) or (2) above, please provide an explanation:

SECTION VII -- FURTHER ACKNOWLEDGMENTS AND CERTIFICATION

The Disclosing Party understands and agrees that:

A. The certifications, disclosures, and acknowledgments contained in this EDS will become part of any contract or other agreement between the ^{Property Owner} Applicant and the City in connection with the Matter, whether procurement, City assistance, or other City action, and are material inducements to the City's execution of any contract or taking other action with respect to the Matter. The Disclosing Party understands that it must comply with all statutes, ordinances, and regulations on which this EDS is based.

B. The City's Governmental Ethics Ordinance, MCC Chapter 2-156, imposes certain duties and obligations on persons or entities seeking City contracts, work, business, or transactions. The full text of this ordinance and a training program is available on line at www.cityofchicago.org/Ethics; and may also be obtained from the City's Board of Ethics, 740 N. Sedgwick St., Suite 500, Chicago, IL 60610, (312) 744-9660. The Disclosing Party must comply fully with this ordinance.

C. If the City determines that any information provided in this EDS is false, incomplete or inaccurate, any contract or other agreement in connection with which it is submitted may be rescinded or be void or voidable, and the City may pursue any remedies under the contract or agreement (if not rescinded or void), at law, or in equity, including terminating the Disclosing Party's participation in the Matter and/or declining to allow the Disclosing Party to participate in other City transactions. Remedies at law for a false statement of material fact may include incarceration and an award to the City of treble damages.

D. It is the City's policy to make this document available to the public on its Internet site and/or upon request. Some or all of the information provided in, and appended to, this EDS may be made publicly available on the Internet, in response to a Freedom of Information Act request, or otherwise. By completing and signing this EDS, the Disclosing Party waives and releases any possible rights or claims which it may have against the City in connection with the public release of information contained in this EDS and also authorizes the City to verify the accuracy of any information submitted in this EDS.

E. The information provided in this EDS must be kept current. In the event of changes, the Disclosing Party must supplement this EDS up to the time the City takes action on the Matter. If the Matter is a contract being handled by the City's Department of Procurement Services, the Disclosing Party must update this EDS as the contract requires. **NOTE:** With respect to Matters subject to MCC Chapter 1-23, Article I (imposing **PERMANENT INELIGIBILITY** for certain specified offenses), the information provided herein regarding eligibility must be kept current for a longer period, as required by MCC Chapter 1-23 and Section 2-154-020.

CERTIFICATION

Under penalty of perjury, the person signing below: (1) warrants that he/she is authorized to execute this EDS, and all applicable Appendices, on behalf of the Disclosing Party, and (2) warrants that all certifications and statements contained in this EDS, and all applicable Appendices, are true, accurate and complete as of the date furnished to the City.

Wanxiang Group Corporation (a PRC Collective-Owned Enterprise)

(Print or type exact legal name of Disclosing Party)

By: _____
(Sign here) *[Handwritten Signature]*

Pin Ni

(Print or type name of person signing)

Authorized Signatory

(Print or type title of person signing)

Signed and sworn to before me on (date) 2/26/19,

at Cook County, Illinois (state).

Raquel E. Cortes

Notary Public



Commission expires: 4/30/22

OFFICIAL SEAL
RAGUEL E. CORTES
NOTARY PUBLIC - STATE OF ILLINOIS
MY COMMISSION EXPIRES 04/15/2025

**CITY OF CHICAGO
ECONOMIC DISCLOSURE STATEMENT AND AFFIDAVIT
APPENDIX A**

**FAMILIAL RELATIONSHIPS WITH ELECTED CITY OFFICIALS
AND DEPARTMENT HEADS**

Property Owner

This Appendix is to be completed only by (a) the Applicant, and (b) any legal entity which has a direct ownership interest in the Applicant exceeding 7.5%. It is not to be completed by any legal entity which has only an indirect ownership interest in the Applicant.

Property Owner

Under MCC Section 2-154-015, the Disclosing Party must disclose whether such Disclosing Party or any "Applicable Party" or any Spouse or Domestic Partner thereof currently has a "familial relationship" with any elected city official or department head. A "familial relationship" exists if, as of the date this EDS is signed, the Disclosing Party or any "Applicable Party" or any Spouse or Domestic Partner thereof is related to the mayor, any alderman, the city clerk, the city treasurer or any city department head as spouse or domestic partner or as any of the following, whether by blood or adoption: parent, child, brother or sister, aunt or uncle, niece or nephew, grandparent, grandchild, father-in-law, mother-in-law, son-in-law, daughter-in-law, stepfather or stepmother, stepson or stepdaughter, stepbrother or stepsister or half-brother or half-sister.

"Applicable Party" means (1) all executive officers of the Disclosing Party listed in Section II.B.1.a., if the Disclosing Party is a corporation; all partners of the Disclosing Party, if the Disclosing Party is a general partnership; all general partners and limited partners of the Disclosing Party, if the Disclosing Party is a limited partnership; all managers, managing members and members of the Disclosing Party, if the Disclosing Party is a limited liability company; (2) all principal officers of the Disclosing Party; and (3) any person having more than a 7.5% ownership interest in the Disclosing Party. "Principal officers" means the president, chief operating officer, executive director, chief financial officer, treasurer or secretary of a legal entity or any person exercising similar authority.

Does the Disclosing Party or any "Applicable Party" or any Spouse or Domestic Partner thereof currently have a "familial relationship" with an elected city official or department head?

[] Yes [X] No

If yes, please identify below (1) the name and title of such person, (2) the name of the legal entity to which such person is connected; (3) the name and title of the elected city official or department head to whom such person has a familial relationship, and (4) the precise nature of such familial relationship.

**CITY OF CHICAGO
ECONOMIC DISCLOSURE STATEMENT AND AFFIDAVIT
APPENDIX B**

BUILDING CODE SCOFFLAW/PROBLEM LANDLORD CERTIFICATION

This Appendix is to be completed only by (a) the ^{Property Owner} ~~Applicant~~, and (b) any legal entity which has a direct ownership interest in the ^{Property Owner} ~~Applicant~~ exceeding 7.5% (an "Owner"). It is not to be completed by any legal entity which has only an indirect ownership interest in the ^{Property Owner} ~~Applicant~~.

1. Pursuant to MCC Section 2-154-010, is the ^{Property Owner} ~~Applicant~~ or any Owner identified as a building code scofflaw or problem landlord pursuant to MCC Section 2-92-416?

Yes No

2. If the ^{Property Owner} ~~Applicant~~ is a legal entity publicly traded on any exchange, is any officer or director of the ^{Property Owner} ~~Applicant~~ identified as a building code scofflaw or problem landlord pursuant to MCC Section 2-92-416?

Yes No The ^{Property Owner} ~~Applicant~~ is not publicly traded on any exchange.

3. If yes to (1) or (2) above, please identify below the name of each person or legal entity identified as a building code scofflaw or problem landlord and the address of each building or buildings to which the pertinent code violations apply.

**CITY OF CHICAGO
ECONOMIC DISCLOSURE STATEMENT AND AFFIDAVIT
APPENDIX C**

PROHIBITION ON WAGE & SALARY HISTORY SCREENING - CERTIFICATION

Property Owner

This Appendix is to be completed only by an ~~Applicant~~ that is completing this EDS as a “contractor” as defined in MCC Section 2-92-385. That section, which should be consulted (www.amlegal.com), generally covers a party to any agreement pursuant to which they: (i) receive City of Chicago funds in consideration for services, work or goods provided (including for legal or other professional services), or (ii) pay the City money for a license, grant or concession allowing them to conduct a business on City premises.

Property Owner

On behalf of an ~~Applicant~~ that is a contractor pursuant to MCC Section 2-92-385, I hereby certify that the ~~Applicant~~ is in compliance with MCC Section 2-92-385(b)(1) and (2), which prohibit: (i) screening job applicants based on their wage or salary history, or (ii) seeking job applicants’ wage or salary history from current or former employers. I also certify that the ~~Applicant~~ has adopted a policy that includes those prohibitions.

Yes

No

Property Owner

N/A – I am not an ~~Applicant~~ that is a “contractor” as defined in MCC Section 2-92-385.

This certification shall serve as the affidavit required by MCC Section 2-92-385(c)(1).

If you checked “no” to the above, please explain.

**CITY OF CHICAGO
ECONOMIC DISCLOSURE STATEMENT
AND AFFIDAVIT**

SECTION I -- GENERAL INFORMATION

A. Legal name of the Disclosing Party submitting this EDS. Include d/b/a/ if applicable:

Wanxiang America Incentive Program Irrevocable Trust (an Illinois Trust)

Check ONE of the following three boxes:

Indicate whether the Disclosing Party submitting this EDS is:

1. the Applicant

OR

2. a legal entity currently holding, or anticipated to hold within six months after City action on the contract, transaction or other undertaking to which this EDS pertains (referred to below as the "Matter"), a direct or indirect interest in excess of 7.5% in the ~~APPLICANT~~. State the ~~APPLICANT'S~~ legal name: 311 N. MORGAN, LLC ~~Property Owner~~ ~~Property Owner~~

OR

3. a legal entity with a direct or indirect right of control of the Applicant (see Section II(B)(1))
State the legal name of the entity in which the Disclosing Party holds a right of control:

B. Business address of the Disclosing Party: 88 Airport Road
Elgin, IL 60123

C. Telephone: 847-921-7064 Fax: 847-931-4339 Email: lkrueger@wanxiang.com

D. Name of contact person: Lawrence J. Krueger

E. Federal Employer Identification No. (if you have one): _____

F. Brief description of the Matter to which this EDS pertains. (Include project number and location of property, if applicable):

Application for planned development for property commonly known as 345 N. Morgan St., 311 N. Morgan St., and 1000 W. Carroll, Chicago, IL

G. Which City agency or department is requesting this EDS? DPD

If the Matter is a contract being handled by the City's Department of Procurement Services, please complete the following:

Specification # N/A and Contract # N/A

SECTION II -- DISCLOSURE OF OWNERSHIP INTERESTS

A. NATURE OF THE DISCLOSING PARTY

1. Indicate the nature of the Disclosing Party:

- Person
 - Publicly registered business corporation
 - Privately held business corporation
 - Sole proprietorship
 - General partnership
 - Limited partnership
 - Trust
 - Limited liability company
 - Limited liability partnership
 - Joint venture
 - Not-for-profit corporation
- (Is the not-for-profit corporation also a 501(c)(3))?
 Yes No
 Other (please specify)

2. For legal entities, the state (or foreign country) of incorporation or organization, if applicable:

Illinois

3. For legal entities not organized in the State of Illinois: Has the organization registered to do business in the State of Illinois as a foreign entity?

- Yes
- No
- Organized in Illinois

B. IF THE DISCLOSING PARTY IS A LEGAL ENTITY:

1. List below the full names and titles, if applicable, of: (i) all executive officers and all directors of the entity; (ii) **for not-for-profit corporations**, all members, if any, which are legal entities (if there are no such members, write "no members which are legal entities"); (iii) **for trusts, estates or other similar entities**, the trustee, executor, administrator, or similarly situated party; (iv) **for general or limited partnerships, limited liability companies, limited liability partnerships or joint ventures**, each general partner, managing member, manager or any other person or legal entity that directly or indirectly controls the day-to-day management of the ~~Applicant~~ Property Owner.

NOTE: Each legal entity listed below must submit an EDS on its own behalf.

Name	Title
<u>Pin Ni</u>	<u>Trustee</u>

2. Please provide the following information concerning each person or legal entity having a direct or indirect, current or prospective (i.e. within 6 months after City action) beneficial interest (including ownership) in excess of 7.5% of the ~~Applicant~~ Property Owner. Examples of such an interest include shares in a corporation, partnership interest in a partnership or joint venture, interest of a member or manager in a

limited liability company, or interest of a beneficiary of a trust, estate or other similar entity. If none, state "None."

NOTE: Each legal entity listed below may be required to submit an EDS on its own behalf.

Name	Business Address	Percentage Interest in the	Property Owner
See attached Exhibit A		Applicant	<input checked="" type="checkbox"/>

SECTION III -- INCOME OR COMPENSATION TO, OR OWNERSHIP BY, CITY ELECTED OFFICIALS

Has the Disclosing Party provided any income or compensation to any City elected official during the 12-month period preceding the date of this EDS? Yes No

Does the Disclosing Party reasonably expect to provide any income or compensation to any City elected official during the 12-month period following the date of this EDS? Yes No

If "yes" to either of the above, please identify below the name(s) of such City elected official(s) and describe such income or compensation:

Does any City elected official or, to the best of the Disclosing Party's knowledge after reasonable inquiry, any City elected official's spouse or domestic partner, have a financial interest (as defined in Chapter 2-156 of the Municipal Code of Chicago ("MCC")) in the Disclosing Party?

Yes No

If "yes," please identify below the name(s) of such City elected official(s) and/or spouse(s)/domestic partner(s) and describe the financial interest(s).

SECTION IV -- DISCLOSURE OF SUBCONTRACTORS AND OTHER RETAINED PARTIES

The Disclosing Party must disclose the name and business address of each subcontractor, attorney, lobbyist (as defined in MCC Chapter 2-156), accountant, consultant and any other person or entity whom the Disclosing Party has retained or expects to retain in connection with the Matter, as well as the nature of the relationship, and the total amount of the fees paid or estimated to be paid. The Disclosing Party is not required to disclose employees who are paid solely through the Disclosing Party's regular payroll. If the Disclosing Party is uncertain whether a disclosure is required under this Section, the Disclosing Party must either ask the City whether disclosure is required or make the disclosure.

Exhibit A
311 N. MORGAN ORGANIZATIONAL CHART
 "Property Owner"

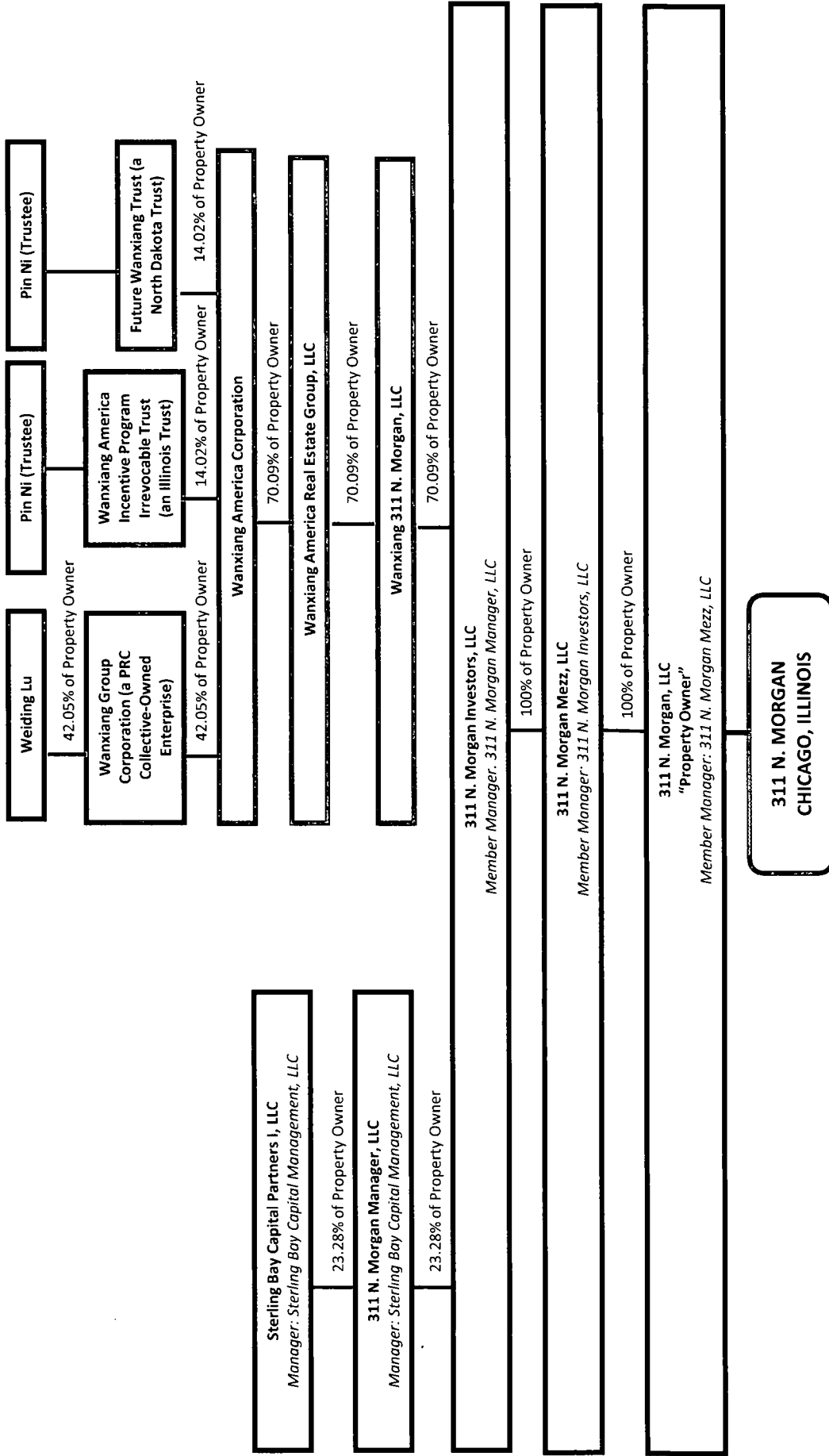

Sterling Bay Capital Partners I, LLC
 Manager: Sterling Bay Capital Management, LLC
 23.28% of Property Owner

311 N. Morgan Manager, LLC
 Manager: Sterling Bay Capital Management, LLC
 23.28% of Property Owner

*All entities in blue have a business address of 1330 W. Fulton Street, Suite 800, Chicago, IL 60607; Wanxiang America Real Estate Group, LLC has a business address of 150 N. Riverside Plaza, Suite 1810, Chicago, IL 60606; Wanxiang 311 N. Morgan, LLC and Wanxiang America Corporation each have a business address of 88 Airport Rd., Elgin, IL 60123; Wanxiang Group Corporation, Wanxiang America Incentive Program Irrevocable Trust, and Future Wanxiang Trust each have a business address of Xiaoshan Economic and Technological Development Zone, Hanzhou, Zhejiang Province, The People's Republic of China

Name (indicate whether retained or anticipated to be retained)	Business Address	Relationship to Disclosing Party (subcontractor, attorney, lobbyist, etc.)	Fees (indicate whether paid or estimated.) NOTE: "hourly rate" or "t.b.d." is not an acceptable response.
--	------------------	--	--

(Add sheets if necessary)

Check here if the Disclosing Party has not retained, nor expects to retain, any such persons or entities.

SECTION V -- CERTIFICATIONS

A. COURT-ORDERED CHILD SUPPORT COMPLIANCE

Under MCC Section 2-92-415, substantial owners of business entities that contract with the City must remain in compliance with their child support obligations throughout the contract's term.

Has any person who directly or indirectly owns 10% or more of the Disclosing Party been declared in arrearage on any child support obligations by any Illinois court of competent jurisdiction?

Yes No No person directly or indirectly owns 10% or more of the Disclosing Party.

If "Yes," has the person entered into a court-approved agreement for payment of all support owed and is the person in compliance with that agreement?

Yes No

B. FURTHER CERTIFICATIONS

1. [This paragraph 1 applies only if the Matter is a contract being handled by the City's Department of Procurement Services.] In the 5-year period preceding the date of this EDS, neither the Disclosing Party nor any Affiliated Entity [see definition in (5) below] has engaged, in connection with the performance of any public contract, the services of an integrity monitor, independent private sector inspector general, or integrity compliance consultant (i.e., an individual or entity with legal, auditing, investigative, or other similar skills, designated by a public agency to help the agency monitor the activity of specified agency vendors as well as help the vendors reform their business practices so they can be considered for agency contracts in the future, or continue with a contract in progress).

2. The Disclosing Party and its Affiliated Entities are not delinquent in the payment of any fine, fee, tax or other source of indebtedness owed to the City of Chicago, including, but not limited to, water and sewer charges, license fees, parking tickets, property taxes and sales taxes, nor is the Disclosing Party delinquent in the payment of any tax administered by the Illinois Department of Revenue.

3. The Disclosing Party and, if the Disclosing Party is a legal entity, all of those persons or entities identified in Section II(B)(1) of this EDS:

- a. are not presently debarred, suspended, proposed for debarment, declared ineligible or voluntarily excluded from any transactions by any federal, state or local unit of government;
- b. have not, during the 5 years before the date of this EDS, been convicted of a criminal offense, adjudged guilty, or had a civil judgment rendered against them in connection with: obtaining, attempting to obtain, or performing a public (federal, state or local) transaction or contract under a public transaction; a violation of federal or state antitrust statutes; fraud; embezzlement; theft; forgery; bribery; falsification or destruction of records; making false statements; or receiving stolen property;
- c. are not presently indicted for, or criminally or civilly charged by, a governmental entity (federal, state or local) with committing any of the offenses set forth in subparagraph (b) above;
- d. have not, during the 5 years before the date of this EDS, had one or more public transactions (federal, state or local) terminated for cause or default; and
- e. have not, during the 5 years before the date of this EDS, been convicted, adjudged guilty, or found liable in a civil proceeding, or in any criminal or civil action, including actions concerning environmental violations, instituted by the City or by the federal government, any state, or any other unit of local government.

4. The Disclosing Party understands and shall comply with the applicable requirements of MCC Chapters 2-56 (Inspector General) and 2-156 (Governmental Ethics).

5. Certifications (5), (6) and (7) concern:

- the Disclosing Party;
- any "Contractor" (meaning any contractor or subcontractor used by the Disclosing Party in connection with the Matter, including but not limited to all persons or legal entities disclosed under Section IV, "Disclosure of Subcontractors and Other Retained Parties");
- any "Affiliated Entity" (meaning a person or entity that, directly or indirectly: controls the Disclosing Party, is controlled by the Disclosing Party, or is, with the Disclosing Party, under common control of another person or entity). Indicia of control include, without limitation: interlocking management or ownership; identity of interests among family members, shared facilities and equipment; common use of employees; or organization of a business entity following the ineligibility of a business entity to do business with federal or state or local government, including the City, using substantially the same management, ownership, or principals as the ineligible entity. With respect to Contractors, the term Affiliated Entity means a person or entity that directly or indirectly controls the Contractor, is controlled by it, or, with the Contractor, is under common control of another person or entity;
- any responsible official of the Disclosing Party, any Contractor or any Affiliated Entity or any other official, agent or employee of the Disclosing Party, any Contractor or any Affiliated Entity, acting pursuant to the direction or authorization of a responsible official of the Disclosing Party, any Contractor or any Affiliated Entity (collectively "Agents").

Neither the Disclosing Party, nor any Contractor, nor any Affiliated Entity of either the Disclosing Party or any Contractor, nor any Agents have, during the 5 years before the date of this EDS, or, with respect to a Contractor, an Affiliated Entity, or an Affiliated Entity of a Contractor during the 5 years before the date of such Contractor's or Affiliated Entity's contract or engagement in connection with the Matter:

a. bribed or attempted to bribe, or been convicted or adjudged guilty of bribery or attempting to bribe, a public officer or employee of the City, the State of Illinois, or any agency of the federal government or of any state or local government in the United States of America, in that officer's or employee's official capacity;

b. agreed or colluded with other bidders or prospective bidders, or been a party to any such agreement, or been convicted or adjudged guilty of agreement or collusion among bidders or prospective bidders, in restraint of freedom of competition by agreement to bid a fixed price or otherwise; or

c. made an admission of such conduct described in subparagraph (a) or (b) above that is a matter of record, but have not been prosecuted for such conduct; or

d. violated the provisions referenced in MCC Subsection 2-92-320(a)(4)(Contracts Requiring a Base Wage); (a)(5)(Debarment Regulations); or (a)(6)(Minimum Wage Ordinance).

6. Neither the Disclosing Party, nor any Affiliated Entity or Contractor, or any of their employees, officials, agents or partners, is barred from contracting with any unit of state or local government as a result of engaging in or being convicted of (1) bid-rigging in violation of 720 ILCS 5/33E-3; (2) bid-rotating in violation of 720 ILCS 5/33E-4; or (3) any similar offense of any state or of the United States of America that contains the same elements as the offense of bid-rigging or bid-rotating.

7. Neither the Disclosing Party nor any Affiliated Entity is listed on a Sanctions List maintained by the United States Department of Commerce, State, or Treasury, or any successor federal agency.

8. [FOR APPLICANT ONLY] (i) Neither the Applicant nor any "controlling person" [see MCC Chapter 1-23, Article I for applicability and defined terms] of the Applicant is currently indicted or charged with, or has admitted guilt of, or has ever been convicted of, or placed under supervision for, any criminal offense involving actual, attempted, or conspiracy to commit bribery, theft, fraud, forgery, perjury, dishonesty or deceit against an officer or employee of the City or any "sister agency"; and (ii) the Applicant understands and acknowledges that compliance with Article I is a continuing requirement for doing business with the City. NOTE: If MCC Chapter 1-23, Article I applies to the Applicant, that Article's permanent compliance timeframe supersedes 5-year compliance timeframes in this Section V.

9. [FOR APPLICANT ONLY] The Applicant and its Affiliated Entities will not use, nor permit their subcontractors to use, any facility listed as having an active exclusion by the U.S. EPA on the federal System for Award Management ("SAM").

10. [FOR APPLICANT ONLY] The Applicant will obtain from any contractors/subcontractors hired or to be hired in connection with the Matter certifications equal in form and substance to those in Certifications (2) and (9) above and will not, without the prior written consent of the City, use any such

contractor/subcontractor that does not provide such certifications or that the Applicant has reason to believe has not provided or cannot provide truthful certifications.

11. If the Disclosing Party is unable to certify to any of the above statements in this Part B (Further Certifications), the Disclosing Party must explain below:

N/A

If the letters "NA," the word "None," or no response appears on the lines above, it will be conclusively presumed that the Disclosing Party certified to the above statements.

12. To the best of the Disclosing Party's knowledge after reasonable inquiry, the following is a complete list of all current employees of the Disclosing Party who were, at any time during the 12-month period preceding the date of this EDS, an employee, or elected or appointed official, of the City of Chicago (if none, indicate with "N/A" or "none").

N/A

13. To the best of the Disclosing Party's knowledge after reasonable inquiry, the following is a complete list of all gifts that the Disclosing Party has given or caused to be given, at any time during the 12-month period preceding the execution date of this EDS, to an employee, or elected or appointed official, of the City of Chicago. For purposes of this statement, a "gift" does not include: (i) anything made generally available to City employees or to the general public, or (ii) food or drink provided in the course of official City business and having a retail value of less than \$25 per recipient, or (iii) a political contribution otherwise duly reported as required by law (if none, indicate with "N/A" or "none"). As to any gift listed below, please also list the name of the City recipient.

N/A

C. CERTIFICATION OF STATUS AS FINANCIAL INSTITUTION

1. The Disclosing Party certifies that the Disclosing Party (check one)
[] is [X] is not

a "financial institution" as defined in MCC Section 2-32-455(b).

2. If the Disclosing Party IS a financial institution, then the Disclosing Party pledges:

"We are not and will not become a predatory lender as defined in MCC Chapter 2-32. We further pledge that none of our affiliates is, and none of them will become, a predatory lender as defined in MCC Chapter 2-32. We understand that becoming a predatory lender or becoming an affiliate of a predatory lender may result in the loss of the privilege of doing business with the City."

If the Disclosing Party is unable to make this pledge because it or any of its affiliates (as defined in MCC Section 2-32-455(b)) is a predatory lender within the meaning of MCC Chapter 2-32, explain here (attach additional pages if necessary):

N/A

If the letters "NA," the word "None," or no response appears on the lines above, it will be conclusively presumed that the Disclosing Party certified to the above statements.

D. CERTIFICATION REGARDING FINANCIAL INTEREST IN CITY BUSINESS

Any words or terms defined in MCC Chapter 2-156 have the same meanings if used in this Part D.

1. In accordance with MCC Section 2-156-110: To the best of the Disclosing Party's knowledge after reasonable inquiry, does any official or employee of the City have a financial interest in his or her own name or in the name of any other person or entity in the Matter?

Yes No

NOTE: If you checked "Yes" to Item D(1), proceed to Items D(2) and D(3). If you checked "No" to Item D(1), skip Items D(2) and D(3) and proceed to Part E.

2. Unless sold pursuant to a process of competitive bidding, or otherwise permitted, no City elected official or employee shall have a financial interest in his or her own name or in the name of any other person or entity in the purchase of any property that (i) belongs to the City, or (ii) is sold for taxes or assessments, or (iii) is sold by virtue of legal process at the suit of the City (collectively, "City Property Sale"). Compensation for property taken pursuant to the City's eminent domain power does not constitute a financial interest within the meaning of this Part D.

Does the Matter involve a City Property Sale?

Yes No

3. If you checked "Yes" to Item D(1), provide the names and business addresses of the City officials or employees having such financial interest and identify the nature of the financial interest:

Name	Business Address	Nature of Financial Interest

4. The Disclosing Party further certifies that no prohibited financial interest in the Matter will be acquired by any City official or employee.

E. CERTIFICATION REGARDING SLAVERY ERA BUSINESS

Please check either (1) or (2) below. If the Disclosing Party checks (2), the Disclosing Party must disclose below or in an attachment to this EDS all information required by (2). Failure to comply with these disclosure requirements may make any contract entered into with the City in connection with the Matter voidable by the City.

X 1. The Disclosing Party verifies that the Disclosing Party has searched any and all records of the Disclosing Party and any and all predecessor entities regarding records of investments or profits from slavery or slaveholder insurance policies during the slavery era (including insurance policies issued to slaveholders that provided coverage for damage to or injury or death of their slaves), and the Disclosing Party has found no such records.

 2. The Disclosing Party verifies that, as a result of conducting the search in step (1) above, the Disclosing Party has found records of investments or profits from slavery or slaveholder insurance policies. The Disclosing Party verifies that the following constitutes full disclosure of all such records, including the names of any and all slaves or slaveholders described in those records:

SECTION VI -- CERTIFICATIONS FOR FEDERALLY FUNDED MATTERS

NOTE: If the Matter is federally funded, complete this Section VI. **If the Matter is not federally funded**, proceed to Section VII. For purposes of this Section VI, tax credits allocated by the City and proceeds of debt obligations of the City are not federal funding.

A. CERTIFICATION REGARDING LOBBYING

1. List below the names of all persons or entities registered under the federal Lobbying Disclosure Act of 1995, as amended, who have made lobbying contacts on behalf of the Disclosing Party with respect to the Matter: (Add sheets if necessary):

(If no explanation appears or begins on the lines above, or if the letters "NA" or if the word "None" appear, it will be conclusively presumed that the Disclosing Party means that NO persons or entities registered under the Lobbying Disclosure Act of 1995, as amended, have made lobbying contacts on behalf of the Disclosing Party with respect to the Matter.)

2. The Disclosing Party has not spent and will not expend any federally appropriated funds to pay any person or entity listed in paragraph A(1) above for his or her lobbying activities or to pay any person or entity to influence or attempt to influence an officer or employee of any agency, as defined by applicable federal law, a member of Congress, an officer or employee of Congress, or an employee

of a member of Congress, in connection with the award of any federally funded contract, making any federally funded grant or loan, entering into any cooperative agreement, or to extend, continue, renew, amend, or modify any federally funded contract, grant, loan, or cooperative agreement.

3. The Disclosing Party will submit an updated certification at the end of each calendar quarter in which there occurs any event that materially affects the accuracy of the statements and information set forth in paragraphs A(1) and A(2) above.

4. The Disclosing Party certifies that either: (i) it is not an organization described in section 501(c)(4) of the Internal Revenue Code of 1986; or (ii) it is an organization described in section 501(c)(4) of the Internal Revenue Code of 1986 but has not engaged and will not engage in "Lobbying Activities," as that term is defined in the Lobbying Disclosure Act of 1995, as amended.

5. If the Disclosing Party is the Applicant, the Disclosing Party must obtain certifications equal in form and substance to paragraphs A(1) through A(4) above from all subcontractors before it awards any subcontract and the Disclosing Party must maintain all such subcontractors' certifications for the duration of the Matter and must make such certifications promptly available to the City upon request.

B. CERTIFICATION REGARDING EQUAL EMPLOYMENT OPPORTUNITY

If the Matter is federally funded, federal regulations require the Applicant and all proposed subcontractors to submit the following information with their bids or in writing at the outset of negotiations.

Is the Disclosing Party the Applicant?

Yes

No

If "Yes," answer the three questions below:

1. Have you developed and do you have on file affirmative action programs pursuant to applicable federal regulations? (See 41 CFR Part 60-2.)

Yes

No

2. Have you filed with the Joint Reporting Committee, the Director of the Office of Federal Contract Compliance Programs, or the Equal Employment Opportunity Commission all reports due under the applicable filing requirements?

Yes

No

Reports not required

3. Have you participated in any previous contracts or subcontracts subject to the equal opportunity clause?

Yes

No

If you checked "No" to question (1) or (2) above, please provide an explanation:

SECTION VII -- FURTHER ACKNOWLEDGMENTS AND CERTIFICATION

The Disclosing Party understands and agrees that:

A. The certifications, disclosures, and acknowledgments contained in this EDS will become part of any contract or other agreement between the ~~Applicant~~^{Property Owner} and the City in connection with the Matter, whether procurement, City assistance, or other City action, and are material inducements to the City's execution of any contract or taking other action with respect to the Matter. The Disclosing Party understands that it must comply with all statutes, ordinances, and regulations on which this EDS is based.

B. The City's Governmental Ethics Ordinance, MCC Chapter 2-156, imposes certain duties and obligations on persons or entities seeking City contracts, work, business, or transactions. The full text of this ordinance and a training program is available on line at www.cityofchicago.org/Ethics, and may also be obtained from the City's Board of Ethics, 740 N. Sedgwick St., Suite 500, Chicago, IL 60610, (312) 744-9660. The Disclosing Party must comply fully with this ordinance.

C. If the City determines that any information provided in this EDS is false, incomplete or inaccurate, any contract or other agreement in connection with which it is submitted may be rescinded or be void or voidable, and the City may pursue any remedies under the contract or agreement (if not rescinded or void), at law, or in equity, including terminating the Disclosing Party's participation in the Matter and/or declining to allow the Disclosing Party to participate in other City transactions. Remedies at law for a false statement of material fact may include incarceration and an award to the City of treble damages.

D. It is the City's policy to make this document available to the public on its Internet site and/or upon request. Some or all of the information provided in, and appended to, this EDS may be made publicly available on the Internet, in response to a Freedom of Information Act request, or otherwise. By completing and signing this EDS, the Disclosing Party waives and releases any possible rights or claims which it may have against the City in connection with the public release of information contained in this EDS and also authorizes the City to verify the accuracy of any information submitted in this EDS.

E. The information provided in this EDS must be kept current. In the event of changes, the Disclosing Party must supplement this EDS up to the time the City takes action on the Matter. If the Matter is a contract being handled by the City's Department of Procurement Services, the Disclosing Party must update this EDS as the contract requires. **NOTE:** With respect to Matters subject to MCC Chapter 1-23, Article 1 (imposing **PERMANENT INELIGIBILITY** for certain specified offenses), the information provided herein regarding eligibility must be kept current for a longer period, as required by MCC Chapter 1-23 and Section 2-154-020.

CERTIFICATION

Under penalty of perjury, the person signing below: (1) warrants that he/she is authorized to execute this EDS, and all applicable Appendices, on behalf of the Disclosing Party, and (2) warrants that all certifications and statements contained in this EDS, and all applicable Appendices, are true, accurate and complete as of the date furnished to the City.

WANXIANG AMERICA INCENTIVE PROGRAM IRREVOCABLE TRUST (an Illinois Trust)
(Print or type exact legal name of Disclosing Party)

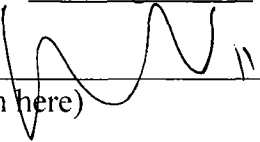
By: 
(Sign here)

Pin Ni
(Print or type name of person signing)

Trustee
(Print or type title of person signing)

Signed and sworn to before me on (date) 2/26/19,

at Cook County, Illinois (state).

Notary Public

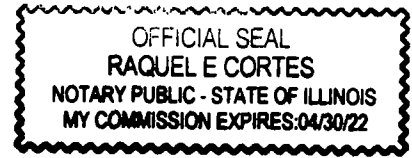

Commission expires: 4/30/22

MY COMMISSION EXPIRES: 04/30/25
NOTARY PUBLIC - STATE OF ILLINOIS
RACHEL F. CORTEZ

**CITY OF CHICAGO
ECONOMIC DISCLOSURE STATEMENT AND AFFIDAVIT
APPENDIX A**

**FAMILIAL RELATIONSHIPS WITH ELECTED CITY OFFICIALS
AND DEPARTMENT HEADS**

Property Owner

This Appendix is to be completed only by (a) the Applicant, and (b) any legal entity which has a direct ownership interest in the Applicant exceeding 7.5%. It is not to be completed by any legal entity which has only an indirect ownership interest in the Applicant.

~~Applicant~~
Property Owner

Property Owner

Under MCC Section 2-154-015, the Disclosing Party must disclose whether such Disclosing Party or any "Applicable Party" or any Spouse or Domestic Partner thereof currently has a "familial relationship" with any elected city official or department head. A "familial relationship" exists if, as of the date this EDS is signed, the Disclosing Party or any "Applicable Party" or any Spouse or Domestic Partner thereof is related to the mayor, any alderman, the city clerk, the city treasurer or any city department head as spouse or domestic partner or as any of the following, whether by blood or adoption: parent, child, brother or sister, aunt or uncle, niece or nephew, grandparent, grandchild, father-in-law, mother-in-law, son-in-law, daughter-in-law, stepfather or stepmother, stepson or stepdaughter, stepbrother or stepsister or half-brother or half-sister.

"Applicable Party" means (1) all executive officers of the Disclosing Party listed in Section II.B.1.a., if the Disclosing Party is a corporation; all partners of the Disclosing Party, if the Disclosing Party is a general partnership; all general partners and limited partners of the Disclosing Party, if the Disclosing Party is a limited partnership; all managers, managing members and members of the Disclosing Party, if the Disclosing Party is a limited liability company; (2) all principal officers of the Disclosing Party; and (3) any person having more than a 7.5% ownership interest in the Disclosing Party. "Principal officers" means the president, chief operating officer, executive director, chief financial officer, treasurer or secretary of a legal entity or any person exercising similar authority.

Does the Disclosing Party or any "Applicable Party" or any Spouse or Domestic Partner thereof currently have a "familial relationship" with an elected city official or department head?

[] Yes

[X] No

If yes, please identify below (1) the name and title of such person, (2) the name of the legal entity to which such person is connected; (3) the name and title of the elected city official or department head to whom such person has a familial relationship, and (4) the precise nature of such familial relationship.

**CITY OF CHICAGO
ECONOMIC DISCLOSURE STATEMENT AND AFFIDAVIT
APPENDIX B**

BUILDING CODE SCOFFLAW/PROBLEM LANDLORD CERTIFICATION

This Appendix is to be completed only by (a) the ^{Property Owner} ~~Applicant~~ and (b) any legal entity which has a direct ownership interest in the ^{Property Owner} ~~Applicant~~ exceeding 7.5% (an "Owner"). It is not to be completed by any legal entity which has only an indirect ownership interest in the ^{Property Owner} ~~Applicant~~.

1. Pursuant to MCC Section 2-154-010, is the ^{Property Owner} ~~Applicant~~ or any Owner identified as a building code scofflaw or problem landlord pursuant to MCC Section 2-92-416?

Yes No

2. If the ^{Property Owner} ~~Applicant~~ is a legal entity publicly traded on any exchange, is any officer or director of the ^{Property Owner} ~~Applicant~~ identified as a building code scofflaw or problem landlord pursuant to MCC Section 2-92-416?

Yes No The ^{Property Owner} ~~Applicant~~ is not publicly traded on any exchange.

3. If yes to (1) or (2) above, please identify below the name of each person or legal entity identified as a building code scofflaw or problem landlord and the address of each building or buildings to which the pertinent code violations apply.

**CITY OF CHICAGO
ECONOMIC DISCLOSURE STATEMENT AND AFFIDAVIT
APPENDIX C**

PROHIBITION ON WAGE & SALARY HISTORY SCREENING - CERTIFICATION

Property Owner

This Appendix is to be completed only by an ~~Applicant~~ that is completing this EDS as a “contractor” as defined in MCC Section 2-92-385. That section, which should be consulted (www.amlegal.com), generally covers a party to any agreement pursuant to which they: (i) receive City of Chicago funds in consideration for services, work or goods provided (including for legal or other professional services), or (ii) pay the City money for a license, grant or concession allowing them to conduct a business on City premises.

Property Owner

On behalf of an ~~Applicant~~ that is a contractor pursuant to MCC Section 2-92-385, I hereby certify that the ~~Applicant~~ is in compliance with MCC Section 2-92-385(b)(1) and (2), which prohibit: (i) screening job applicants based on their wage or salary history, or (ii) seeking job applicants’ wage or salary history from current or former employers. I also certify that the ~~Applicant~~ has adopted a policy that includes those prohibitions.

Yes

No

Property Owner

N/A – I am not an ~~Applicant~~ that is a “contractor” as defined in MCC Section 2-92-385.

This certification shall serve as the affidavit required by MCC Section 2-92-385(c)(1).

If you checked “no” to the above, please explain.

**CITY OF CHICAGO
ECONOMIC DISCLOSURE STATEMENT
AND AFFIDAVIT**

SECTION I -- GENERAL INFORMATION

A. Legal name of the Disclosing Party submitting this EDS. Include d/b/a/ if applicable:

Future Wanxiang Trust (a North Dakota Trust)

Check ONE of the following three boxes:

Indicate whether the Disclosing Party submitting this EDS is:

1. the Applicant
OR

2. a legal entity currently holding, or anticipated to hold within six months after City action on the contract, transaction or other undertaking to which this EDS pertains (referred to below as the "Matter"), a direct or indirect interest in excess of 7.5% in the ~~Applicant~~. State the ~~Applicant's~~ legal name: 311 N. Morgan, LLC
Property Owner Property Owner
OR

3. a legal entity with a direct or indirect right of control of the Applicant (see Section II(B)(1))
State the legal name of the entity in which the Disclosing Party holds a right of control:

B. Business address of the Disclosing Party: .88 Airport Road
Elgin, IL 60123

C. Telephone: 847-921-7064 Fax: 847-931-4339 Email: lkrueger@wanxiang.com

D. Name of contact person: Lawrence J. Krueger

E. Federal Employer Identification No. (if you have one): _____

F. Brief description of the Matter to which this EDS pertains. (Include project number and location of property, if applicable):

Application for planned development for property commonly known as 345 N. Morgan St., 311 N. Morgan St., and 1000 W. Carroll, Chicago, IL

G. Which City agency or department is requesting this EDS? DPD

If the Matter is a contract being handled by the City's Department of Procurement Services, please complete the following:

Specification # N/A and Contract # N/A

SECTION II -- DISCLOSURE OF OWNERSHIP INTERESTS

A. NATURE OF THE DISCLOSING PARTY

1. Indicate the nature of the Disclosing Party:

- Person
- Publicly registered business corporation
- Privately held business corporation
- Sole proprietorship
- General partnership
- Limited partnership
- Trust
- Limited liability company
- Limited liability partnership
- Joint venture
- Not-for-profit corporation
- (Is the not-for-profit corporation also a 501(c)(3))?
 Yes No
- Other (please specify)

2. For legal entities, the state (or foreign country) of incorporation or organization, if applicable:

North Dakota

3. For legal entities not organized in the State of Illinois: Has the organization registered to do business in the State of Illinois as a foreign entity?

- Yes
- No
- Organized in Illinois

B. IF THE DISCLOSING PARTY IS A LEGAL ENTITY:

1. List below the full names and titles, if applicable, of: (i) all executive officers and all directors of the entity; (ii) **for not-for-profit corporations**, all members, if any, which are legal entities (if there are no such members, write "no members which are legal entities"); (iii) **for trusts, estates or other similar entities**, the trustee, executor, administrator, or similarly situated party; (iv) **for general or limited partnerships, limited liability companies, limited liability partnerships or joint ventures**, each general partner, managing member, manager or any other person or legal entity that directly or indirectly controls the day-to-day management of the ~~Applicant~~ **Property Owner**.

NOTE: Each legal entity listed below must submit an EDS on its own behalf.

Name	Title
Pin Ni	Trustee

2. Please provide the following information concerning each person or legal entity having a direct or indirect, current or prospective (i.e. within 6 months after City action) beneficial interest (including ownership) in excess of 7.5% of the ~~Applicant~~ **Property Owner**. Examples of such an interest include shares in a corporation, partnership interest in a partnership or joint venture, interest of a member or manager in a

limited liability company, or interest of a beneficiary of a trust, estate or other similar entity. If none, state "None."

NOTE: Each legal entity listed below may be required to submit an EDS on its own behalf.

Name	Business Address	Percentage Interest in the	Property Owner Applicant
See attached Exhibit A			

SECTION III -- INCOME OR COMPENSATION TO, OR OWNERSHIP BY, CITY ELECTED OFFICIALS

Has the Disclosing Party provided any income or compensation to any City elected official during the 12-month period preceding the date of this EDS? [] Yes [X] No

Does the Disclosing Party reasonably expect to provide any income or compensation to any City elected official during the 12-month period following the date of this EDS? [] Yes [X] No

If "yes" to either of the above, please identify below the name(s) of such City elected official(s) and describe such income or compensation:

Does any City elected official or, to the best of the Disclosing Party's knowledge after reasonable inquiry, any City elected official's spouse or domestic partner, have a financial interest (as defined in Chapter 2-156 of the Municipal Code of Chicago ("MCC")) in the Disclosing Party?

[] Yes [X] No

If "yes," please identify below the name(s) of such City elected official(s) and/or spouse(s)/domestic partner(s) and describe the financial interest(s).

SECTION IV -- DISCLOSURE OF SUBCONTRACTORS AND OTHER RETAINED PARTIES

The Disclosing Party must disclose the name and business address of each subcontractor, attorney, lobbyist (as defined in MCC Chapter 2-156), accountant, consultant and any other person or entity whom the Disclosing Party has retained or expects to retain in connection with the Matter, as well as the nature of the relationship, and the total amount of the fees paid or estimated to be paid. The Disclosing Party is not required to disclose employees who are paid solely through the Disclosing Party's regular payroll. If the Disclosing Party is uncertain whether a disclosure is required under this Section, the Disclosing Party must either ask the City whether disclosure is required or make the disclosure.

Exhibit A
311 N. MORGAN ORGANIZATIONAL CHART
 "Property Owner"

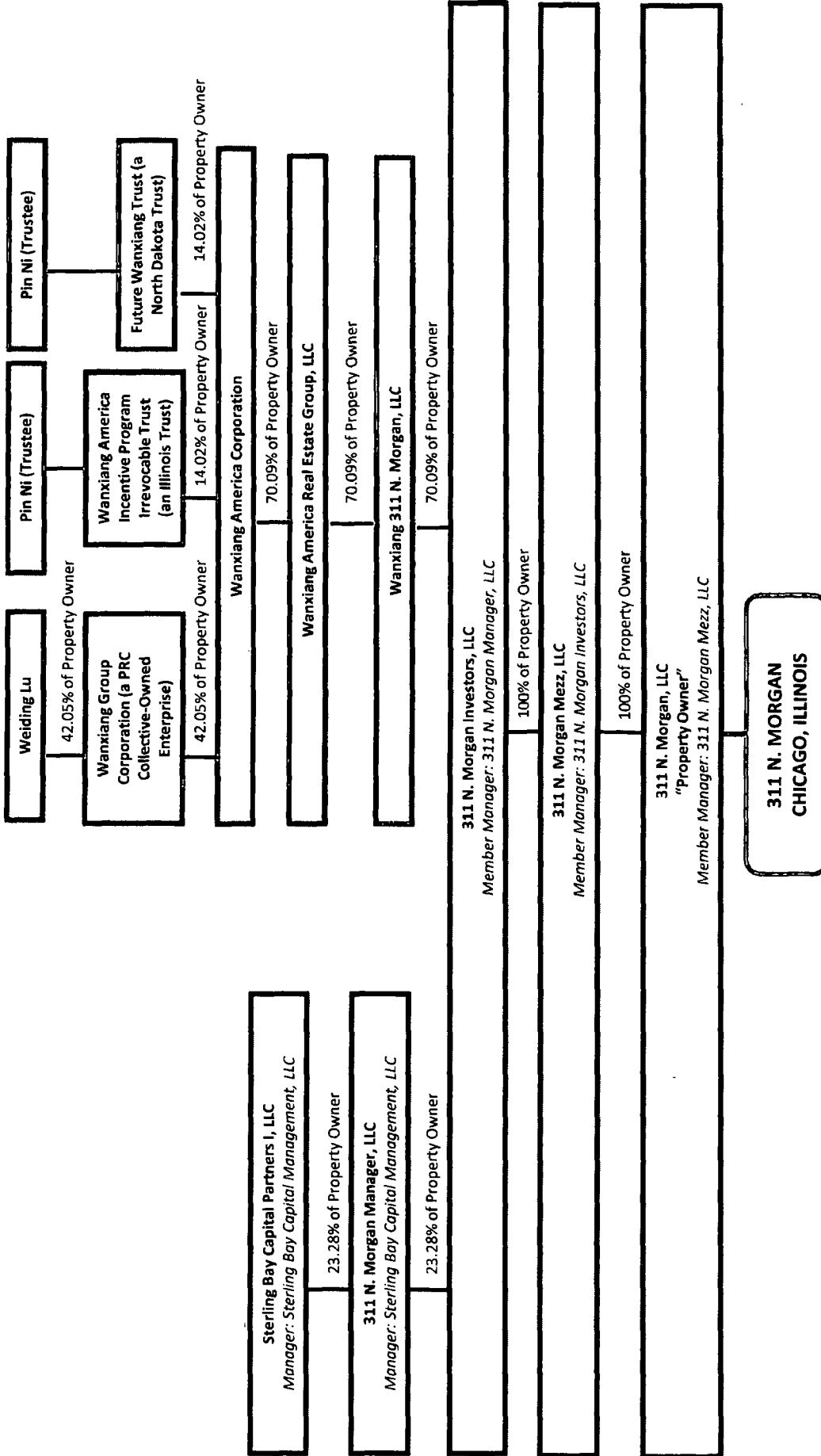

Sterling Bay Capital Partners I, LLC
 Manager: Sterling Bay Capital Management, LLC

311 N. Morgan Manager, LLC
 Manager: Sterling Bay Capital Management, LLC

311 N. Morgan Investors, LLC
 Member Manager: 311 N. Morgan Manager, LLC

311 N. Morgan Mezz, LLC
 Member Manager: 311 N. Morgan Investors, LLC

311 N. Morgan, LLC
 "Property Owner"
 Member Manager: 311 N. Morgan Mezz, LLC

311 N. MORGAN
CHICAGO, ILLINOIS

*All entities in blue have a business address of 1330 W. Fulton Street, Suite 800, Chicago, IL 60607; Wanxiang America Real Estate Group, LLC has a business address of 150 N. Riverside Plaza, Suite 1810, Chicago, IL 60606; Wanxiang 311 N. Morgan, LLC and Wanxiang America Corporation each have a business address of 88 Airport Rd., Elgin, IL 60123; Wanxiang Group Corporation, Wanxiang America Incentive Program Irrevocable Trust, and Future Wanxiang Trust each have a business address of Xiaoshan Economic and Technological Development Zone, Hanzhou, Zhejiang Province, The People's Republic of China

Name (indicate whether retained or anticipated to be retained)	Business Address	Relationship to Disclosing Party (subcontractor, attorney, lobbyist, etc.)	Fees (<u>indicate whether paid or estimated.</u>) NOTE: "hourly rate" or "t.b.d." is not an acceptable response.
--	------------------	--	---

(Add sheets if necessary)

Check here if the Disclosing Party has not retained, nor expects to retain, any such persons or entities.

SECTION V -- CERTIFICATIONS

A. COURT-ORDERED CHILD SUPPORT COMPLIANCE

Under MCC Section 2-92-415, substantial owners of business entities that contract with the City must remain in compliance with their child support obligations throughout the contract's term.

Has any person who directly or indirectly owns 10% or more of the Disclosing Party been declared in arrearage on any child support obligations by any Illinois court of competent jurisdiction?

Yes No No person directly or indirectly owns 10% or more of the Disclosing Party.

If "Yes," has the person entered into a court-approved agreement for payment of all support owed and is the person in compliance with that agreement?

Yes No

B. FURTHER CERTIFICATIONS

1. [This paragraph 1 applies only if the Matter is a contract being handled by the City's Department of Procurement Services.] In the 5-year period preceding the date of this EDS, neither the Disclosing Party nor any Affiliated Entity [see definition in (5) below] has engaged, in connection with the performance of any public contract, the services of an integrity monitor, independent private sector inspector general, or integrity compliance consultant (i.e., an individual or entity with legal, auditing, investigative, or other similar skills, designated by a public agency to help the agency monitor the activity of specified agency vendors as well as help the vendors reform their business practices so they can be considered for agency contracts in the future, or continue with a contract in progress).

2. The Disclosing Party and its Affiliated Entities are not delinquent in the payment of any fine, fee, tax or other source of indebtedness owed to the City of Chicago, including, but not limited to, water and sewer charges, license fees, parking tickets, property taxes and sales taxes, nor is the Disclosing Party delinquent in the payment of any tax administered by the Illinois Department of Revenue.

3. The Disclosing Party and, if the Disclosing Party is a legal entity, all of those persons or entities identified in Section II(B)(1) of this EDS:

a. are not presently debarred, suspended, proposed for debarment, declared ineligible or voluntarily excluded from any transactions by any federal, state or local unit of government;

b. have not, during the 5 years before the date of this EDS, been convicted of a criminal offense, adjudged guilty, or had a civil judgment rendered against them in connection with: obtaining, attempting to obtain, or performing a public (federal, state or local) transaction or contract under a public transaction; a violation of federal or state antitrust statutes; fraud; embezzlement; theft; forgery; bribery; falsification or destruction of records; making false statements; or receiving stolen property;

c. are not presently indicted for, or criminally or civilly charged by, a governmental entity (federal, state or local) with committing any of the offenses set forth in subparagraph (b) above;

d. have not, during the 5 years before the date of this EDS, had one or more public transactions (federal, state or local) terminated for cause or default; and

e. have not, during the 5 years before the date of this EDS, been convicted, adjudged guilty, or found liable in a civil proceeding, or in any criminal or civil action, including actions concerning environmental violations, instituted by the City or by the federal government, any state, or any other unit of local government.

4. The Disclosing Party understands and shall comply with the applicable requirements of MCC Chapters 2-56 (Inspector General) and 2-156 (Governmental Ethics).

5. Certifications (5), (6) and (7) concern:

- the Disclosing Party;
- any "Contractor" (meaning any contractor or subcontractor used by the Disclosing Party in connection with the Matter, including but not limited to all persons or legal entities disclosed under Section IV, "Disclosure of Subcontractors and Other Retained Parties");
- any "Affiliated Entity" (meaning a person or entity that, directly or indirectly: controls the Disclosing Party, is controlled by the Disclosing Party, or is, with the Disclosing Party, under common control of another person or entity). Indicia of control include, without limitation: interlocking management or ownership; identity of interests among family members, shared facilities and equipment; common use of employees; or organization of a business entity following the ineligibility of a business entity to do business with federal or state or local government, including the City, using substantially the same management, ownership, or principals as the ineligible entity. With respect to Contractors, the term Affiliated Entity means a person or entity that directly or indirectly controls the Contractor, is controlled by it, or, with the Contractor, is under common control of another person or entity;
- any responsible official of the Disclosing Party, any Contractor or any Affiliated Entity or any other official, agent or employee of the Disclosing Party, any Contractor or any Affiliated Entity, acting pursuant to the direction or authorization of a responsible official of the Disclosing Party, any Contractor or any Affiliated Entity (collectively "Agents").

Neither the Disclosing Party, nor any Contractor, nor any Affiliated Entity of either the Disclosing Party or any Contractor, nor any Agents have, during the 5 years before the date of this EDS, or, with respect to a Contractor, an Affiliated Entity, or an Affiliated Entity of a Contractor during the 5 years before the date of such Contractor's or Affiliated Entity's contract or engagement in connection with the Matter:

- a. bribed or attempted to bribe, or been convicted or adjudged guilty of bribery or attempting to bribe, a public officer or employee of the City, the State of Illinois, or any agency of the federal government or of any state or local government in the United States of America, in that officer's or employee's official capacity;
 - b. agreed or colluded with other bidders or prospective bidders, or been a party to any such agreement, or been convicted or adjudged guilty of agreement or collusion among bidders or prospective bidders, in restraint of freedom of competition by agreement to bid a fixed price or otherwise; or
 - c. made an admission of such conduct described in subparagraph (a) or (b) above that is a matter of record, but have not been prosecuted for such conduct; or
 - d. violated the provisions referenced in MCC Subsection 2-92-320(a)(4)(Contracts Requiring a Base Wage); (a)(5)(Debarment Regulations); or (a)(6)(Minimum Wage Ordinance).
6. Neither the Disclosing Party, nor any Affiliated Entity or Contractor, or any of their employees, officials, agents or partners, is barred from contracting with any unit of state or local government as a result of engaging in or being convicted of (1) bid-rigging in violation of 720 ILCS 5/33E-3; (2) bid-rotating in violation of 720 ILCS 5/33E-4; or (3) any similar offense of any state or of the United States of America that contains the same elements as the offense of bid-rigging or bid-rotating.
7. Neither the Disclosing Party nor any Affiliated Entity is listed on a Sanctions List maintained by the United States Department of Commerce, State, or Treasury, or any successor federal agency.
8. [FOR APPLICANT ONLY] (i) Neither the Applicant nor any "controlling person" [see MCC Chapter 1-23, Article I for applicability and defined terms] of the Applicant is currently indicted or charged with, or has admitted guilt of, or has ever been convicted of, or placed under supervision for, any criminal offense involving actual, attempted, or conspiracy to commit bribery, theft, fraud, forgery, perjury, dishonesty or deceit against an officer or employee of the City or any "sister agency"; and (ii) the Applicant understands and acknowledges that compliance with Article I is a continuing requirement for doing business with the City. NOTE: If MCC Chapter 1-23, Article I applies to the Applicant, that Article's permanent compliance timeframe supersedes 5-year compliance timeframes in this Section V.
9. [FOR APPLICANT ONLY] The Applicant and its Affiliated Entities will not use, nor permit their subcontractors to use, any facility listed as having an active exclusion by the U.S. EPA on the federal System for Award Management ("SAM").
10. [FOR APPLICANT ONLY] The Applicant will obtain from any contractors/subcontractors hired or to be hired in connection with the Matter certifications equal in form and substance to those in Certifications (2) and (9) above and will not, without the prior written consent of the City, use any such

contractor/subcontractor that does not provide such certifications or that the Applicant has reason to believe has not provided or cannot provide truthful certifications.

11. If the Disclosing Party is unable to certify to any of the above statements in this Part B (Further Certifications), the Disclosing Party must explain below:

N/A

If the letters "NA," the word "None," or no response appears on the lines above, it will be conclusively presumed that the Disclosing Party certified to the above statements.

12. To the best of the Disclosing Party's knowledge after reasonable inquiry, the following is a complete list of all current employees of the Disclosing Party who were, at any time during the 12-month period preceding the date of this EDS, an employee, or elected or appointed official, of the City of Chicago (if none, indicate with "N/A" or "none").

N/A

13. To the best of the Disclosing Party's knowledge after reasonable inquiry, the following is a complete list of all gifts that the Disclosing Party has given or caused to be given, at any time during the 12-month period preceding the execution date of this EDS, to an employee, or elected or appointed official, of the City of Chicago. For purposes of this statement, a "gift" does not include: (i) anything made generally available to City employees or to the general public, or (ii) food or drink provided in the course of official City business and having a retail value of less than \$25 per recipient, or (iii) a political contribution otherwise duly reported as required by law (if none, indicate with "N/A" or "none"). As to any gift listed below, please also list the name of the City recipient.

N/A

C. CERTIFICATION OF STATUS AS FINANCIAL INSTITUTION

1. The Disclosing Party certifies that the Disclosing Party (check one)

is is not

a "financial institution" as defined in MCC Section 2-32-455(b).

2. If the Disclosing Party IS a financial institution, then the Disclosing Party pledges:

"We are not and will not become a predatory lender as defined in MCC Chapter 2-32. We further pledge that none of our affiliates is, and none of them will become, a predatory lender as defined in MCC Chapter 2-32. We understand that becoming a predatory lender or becoming an affiliate of a predatory lender may result in the loss of the privilege of doing business with the City."

If the Disclosing Party is unable to make this pledge because it or any of its affiliates (as defined in MCC Section 2-32-455(b)) is a predatory lender within the meaning of MCC Chapter 2-32, explain here (attach additional pages if necessary):

N/A

If the letters "NA," the word "None," or no response appears on the lines above, it will be conclusively presumed that the Disclosing Party certified to the above statements.

D. CERTIFICATION REGARDING FINANCIAL INTEREST IN CITY BUSINESS

Any words or terms defined in MCC Chapter 2-156 have the same meanings if used in this Part D.

1. In accordance with MCC Section 2-156-110: To the best of the Disclosing Party's knowledge after reasonable inquiry, does any official or employee of the City have a financial interest in his or her own name or in the name of any other person or entity in the Matter?

Yes

No

NOTE: If you checked "Yes" to Item D(1), proceed to Items D(2) and D(3). If you checked "No" to Item D(1), skip Items D(2) and D(3) and proceed to Part E.

2. Unless sold pursuant to a process of competitive bidding, or otherwise permitted, no City elected official or employee shall have a financial interest in his or her own name or in the name of any other person or entity in the purchase of any property that (i) belongs to the City, or (ii) is sold for taxes or assessments, or (iii) is sold by virtue of legal process at the suit of the City (collectively, "City Property Sale"). Compensation for property taken pursuant to the City's eminent domain power does not constitute a financial interest within the meaning of this Part D.

Does the Matter involve a City Property Sale?

Yes

No

3. If you checked "Yes" to Item D(1), provide the names and business addresses of the City officials or employees having such financial interest and identify the nature of the financial interest:

Name	Business Address	Nature of Financial Interest
<hr/>		
<hr/>		
<hr/>		

4. The Disclosing Party further certifies that no prohibited financial interest in the Matter will be acquired by any City official or employee.

E. CERTIFICATION REGARDING SLAVERY ERA BUSINESS

Please check either (1) or (2) below. If the Disclosing Party checks (2), the Disclosing Party must disclose below or in an attachment to this EDS all information required by (2). Failure to comply with these disclosure requirements may make any contract entered into with the City in connection with the Matter voidable by the City.

X 1. The Disclosing Party verifies that the Disclosing Party has searched any and all records of the Disclosing Party and any and all predecessor entities regarding records of investments or profits from slavery or slaveholder insurance policies during the slavery era (including insurance policies issued to slaveholders that provided coverage for damage to or injury or death of their slaves), and the Disclosing Party has found no such records.

___ 2. The Disclosing Party verifies that, as a result of conducting the search in step (1) above, the Disclosing Party has found records of investments or profits from slavery or slaveholder insurance policies. The Disclosing Party verifies that the following constitutes full disclosure of all such records, including the names of any and all slaves or slaveholders described in those records:

SECTION VI -- CERTIFICATIONS FOR FEDERALLY FUNDED MATTERS

NOTE: If the Matter is federally funded, complete this Section VI. If the Matter is not federally funded, proceed to Section VII. For purposes of this Section VI, tax credits allocated by the City and proceeds of debt obligations of the City are not federal funding.

A. CERTIFICATION REGARDING LOBBYING

1. List below the names of all persons or entities registered under the federal Lobbying Disclosure Act of 1995, as amended, who have made lobbying contacts on behalf of the Disclosing Party with respect to the Matter: (Add sheets if necessary):

(If no explanation appears or begins on the lines above, or if the letters "NA" or if the word "None" appear, it will be conclusively presumed that the Disclosing Party means that NO persons or entities registered under the Lobbying Disclosure Act of 1995, as amended, have made lobbying contacts on behalf of the Disclosing Party with respect to the Matter.)

2. The Disclosing Party has not spent and will not expend any federally appropriated funds to pay any person or entity listed in paragraph A(1) above for his or her lobbying activities or to pay any person or entity to influence or attempt to influence an officer or employee of any agency, as defined by applicable federal law, a member of Congress, an officer or employee of Congress, or an employee

of a member of Congress, in connection with the award of any federally funded contract, making any federally funded grant or loan, entering into any cooperative agreement, or to extend, continue, renew, amend, or modify any federally funded contract, grant, loan, or cooperative agreement.

3. The Disclosing Party will submit an updated certification at the end of each calendar quarter in which there occurs any event that materially affects the accuracy of the statements and information set forth in paragraphs A(1) and A(2) above.

4. The Disclosing Party certifies that either: (i) it is not an organization described in section 501(c)(4) of the Internal Revenue Code of 1986; or (ii) it is an organization described in section 501(c)(4) of the Internal Revenue Code of 1986 but has not engaged and will not engage in "Lobbying Activities," as that term is defined in the Lobbying Disclosure Act of 1995, as amended.

5. If the Disclosing Party is the Applicant, the Disclosing Party must obtain certifications equal in form and substance to paragraphs A(1) through A(4) above from all subcontractors before it awards any subcontract and the Disclosing Party must maintain all such subcontractors' certifications for the duration of the Matter and must make such certifications promptly available to the City upon request.

B. CERTIFICATION REGARDING EQUAL EMPLOYMENT OPPORTUNITY

If the Matter is federally funded, federal regulations require the Applicant and all proposed subcontractors to submit the following information with their bids or in writing at the outset of negotiations.

Is the Disclosing Party the Applicant?

Yes No

If "Yes," answer the three questions below:

1. Have you developed and do you have on file affirmative action programs pursuant to applicable federal regulations? (See 41 CFR Part 60-2.)

Yes No

2. Have you filed with the Joint Reporting Committee, the Director of the Office of Federal Contract Compliance Programs, or the Equal Employment Opportunity Commission all reports due under the applicable filing requirements?

Yes No Reports not required

3. Have you participated in any previous contracts or subcontracts subject to the equal opportunity clause?

Yes No

If you checked "No" to question (1) or (2) above, please provide an explanation:

SECTION VII -- FURTHER ACKNOWLEDGMENTS AND CERTIFICATION

The Disclosing Party understands and agrees that:

A. The certifications, disclosures, and acknowledgments contained in this EDS will become part of any contract or other agreement between the ^{Property Owner} Applicant and the City in connection with the Matter, whether procurement, City assistance, or other City action, and are material inducements to the City's execution of any contract or taking other action with respect to the Matter. The Disclosing Party understands that it must comply with all statutes, ordinances, and regulations on which this EDS is based.

B. The City's Governmental Ethics Ordinance, MCC Chapter 2-156, imposes certain duties and obligations on persons or entities seeking City contracts, work, business, or transactions. The full text of this ordinance and a training program is available on line at www.cityofchicago.org/Ethics, and may also be obtained from the City's Board of Ethics, 740 N. Sedgwick St., Suite 500, Chicago, IL 60610, (312) 744-9660. The Disclosing Party must comply fully with this ordinance.

C. If the City determines that any information provided in this EDS is false, incomplete or inaccurate, any contract or other agreement in connection with which it is submitted may be rescinded or be void or voidable, and the City may pursue any remedies under the contract or agreement (if not rescinded or void), at law, or in equity, including terminating the Disclosing Party's participation in the Matter and/or declining to allow the Disclosing Party to participate in other City transactions. Remedies at law for a false statement of material fact may include incarceration and an award to the City of treble damages.

D. It is the City's policy to make this document available to the public on its Internet site and/or upon request. Some or all of the information provided in, and appended to, this EDS may be made publicly available on the Internet, in response to a Freedom of Information Act request, or otherwise. By completing and signing this EDS, the Disclosing Party waives and releases any possible rights or claims which it may have against the City in connection with the public release of information contained in this EDS and also authorizes the City to verify the accuracy of any information submitted in this EDS.

E. The information provided in this EDS must be kept current. In the event of changes, the Disclosing Party must supplement this EDS up to the time the City takes action on the Matter. If the Matter is a contract being handled by the City's Department of Procurement Services, the Disclosing Party must update this EDS as the contract requires. **NOTE:** With respect to Matters subject to MCC Chapter 1-23, Article I (imposing **PERMANENT INELIGIBILITY** for certain specified offenses), the information provided herein regarding eligibility must be kept current for a longer period, as required by MCC Chapter 1-23 and Section 2-154-020.

CERTIFICATION

Under penalty of perjury, the person signing below: (1) warrants that he/she is authorized to execute this EDS, and all applicable Appendices, on behalf of the Disclosing Party, and (2) warrants that all certifications and statements contained in this EDS, and all applicable Appendices, are true, accurate and complete as of the date furnished to the City.

Future Wanxiang Trust (an North Dakota Trust)
(Print or type exact legal name of Disclosing Party)

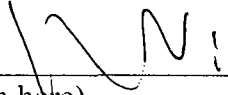
By: 
(Sign here)

Pin Ni
(Print or type name of person signing)

Trustee
(Print or type title of person signing)

Signed and sworn to before me on (date) 2/26/19.

at Cook County, Illinois (state).

Raquel E. Cortes
Notary Public



Commission expires: 4/30/22

OFFICIAL SEAL
RACHEL E. COATES
NOTARY PUBLIC - STATE OF ILLINOIS
MY COMMISSION EXPIRES 04/30/23

**CITY OF CHICAGO
ECONOMIC DISCLOSURE STATEMENT AND AFFIDAVIT
APPENDIX A**

**FAMILIAL RELATIONSHIPS WITH ELECTED CITY OFFICIALS
AND DEPARTMENT HEADS**

Property Owner

This Appendix is to be completed only by (a) the Applicant, and (b) any legal entity which has a direct ownership interest in the Applicant exceeding 7.5%. It is not to be completed by any legal entity which has only an indirect ownership interest in the Applicant.

~~Applicant~~
Property Owner

Property Owner

Under MCC Section 2-154-015, the Disclosing Party must disclose whether such Disclosing Party or any "Applicable Party" or any Spouse or Domestic Partner thereof currently has a "familial relationship" with any elected city official or department head. A "familial relationship" exists if, as of the date this EDS is signed, the Disclosing Party or any "Applicable Party" or any Spouse or Domestic Partner thereof is related to the mayor, any alderman, the city clerk, the city treasurer or any city department head as spouse or domestic partner or as any of the following, whether by blood or adoption: parent, child, brother or sister, aunt or uncle, niece or nephew, grandparent, grandchild, father-in-law, mother-in-law, son-in-law, daughter-in-law, stepfather or stepmother, stepson or stepdaughter, stepbrother or stepsister or half-brother or half-sister.

"Applicable Party" means (1) all executive officers of the Disclosing Party listed in Section II.B.1.a., if the Disclosing Party is a corporation; all partners of the Disclosing Party, if the Disclosing Party is a general partnership; all general partners and limited partners of the Disclosing Party, if the Disclosing Party is a limited partnership; all managers, managing members and members of the Disclosing Party, if the Disclosing Party is a limited liability company; (2) all principal officers of the Disclosing Party; and (3) any person having more than a 7.5% ownership interest in the Disclosing Party. "Principal officers" means the president, chief operating officer, executive director, chief financial officer, treasurer or secretary of a legal entity or any person exercising similar authority.

Does the Disclosing Party or any "Applicable Party" or any Spouse or Domestic Partner thereof currently have a "familial relationship" with an elected city official or department head?

Yes

No

If yes, please identify below (1) the name and title of such person, (2) the name of the legal entity to which such person is connected; (3) the name and title of the elected city official or department head to whom such person has a familial relationship, and (4) the precise nature of such familial relationship.

**CITY OF CHICAGO
ECONOMIC DISCLOSURE STATEMENT AND AFFIDAVIT
APPENDIX B**

BUILDING CODE SCOFFLAW/PROBLEM LANDLORD CERTIFICATION

This Appendix is to be completed only by (a) the ^{Property Owner} ~~Applicant~~, and (b) any legal entity which has a direct ownership interest in the ^{Property Owner} ~~Applicant~~ exceeding 7.5% (an "Owner"). It is not to be completed by any legal entity which has only an indirect ownership interest in the ^{Property Owner} ~~Applicant~~.

1. Pursuant to MCC Section 2-154-010, is the ^{Property Owner} ~~Applicant~~ or any Owner identified as a building code scofflaw or problem landlord pursuant to MCC Section 2-92-416?

Yes No

2. If the ^{Property Owner} ~~Applicant~~ is a legal entity publicly traded on any exchange, is any officer or director of the ^{Property Owner} ~~Applicant~~ identified as a building code scofflaw or problem landlord pursuant to MCC Section 2-92-416?

Yes No The ^{Property Owner} ~~Applicant~~ is not publicly traded on any exchange.

3. If yes to (1) or (2) above, please identify below the name of each person or legal entity identified as a building code scofflaw or problem landlord and the address of each building or buildings to which the pertinent code violations apply.

**CITY OF CHICAGO
ECONOMIC DISCLOSURE STATEMENT AND AFFIDAVIT
APPENDIX C**

PROHIBITION ON WAGE & SALARY HISTORY SCREENING - CERTIFICATION

Property Owner

This Appendix is to be completed only by an ~~Applicant~~ that is completing this EDS as a “contractor” as defined in MCC Section 2-92-385. That section, which should be consulted (www.amlegal.com), generally covers a party to any agreement pursuant to which they: (i) receive City of Chicago funds in consideration for services, work or goods provided (including for legal or other professional services), or (ii) pay the City money for a license, grant or concession allowing them to conduct a business on City premises.

Property Owner

On behalf of an ~~Applicant~~ that is a contractor pursuant to MCC Section 2-92-385, I hereby certify that the ~~Applicant~~ is in compliance with MCC Section 2-92-385(b)(1) and (2), which prohibit: (i) screening job applicants based on their wage or salary history, or (ii) seeking job applicants’ wage or salary history from current or former employers. I also certify that the ~~Applicant~~ has adopted a policy that includes those prohibitions.

Yes

No

Property Owner

N/A – I am not an ~~Applicant~~ that is a “contractor” as defined in MCC Section 2-92-385.

This certification shall serve as the affidavit required by MCC Section 2-92-385(c)(1).

If you checked “no” to the above, please explain.

Exhibit A

345 N. MORGAN ORGANIZATIONAL CHART

"Applicant"

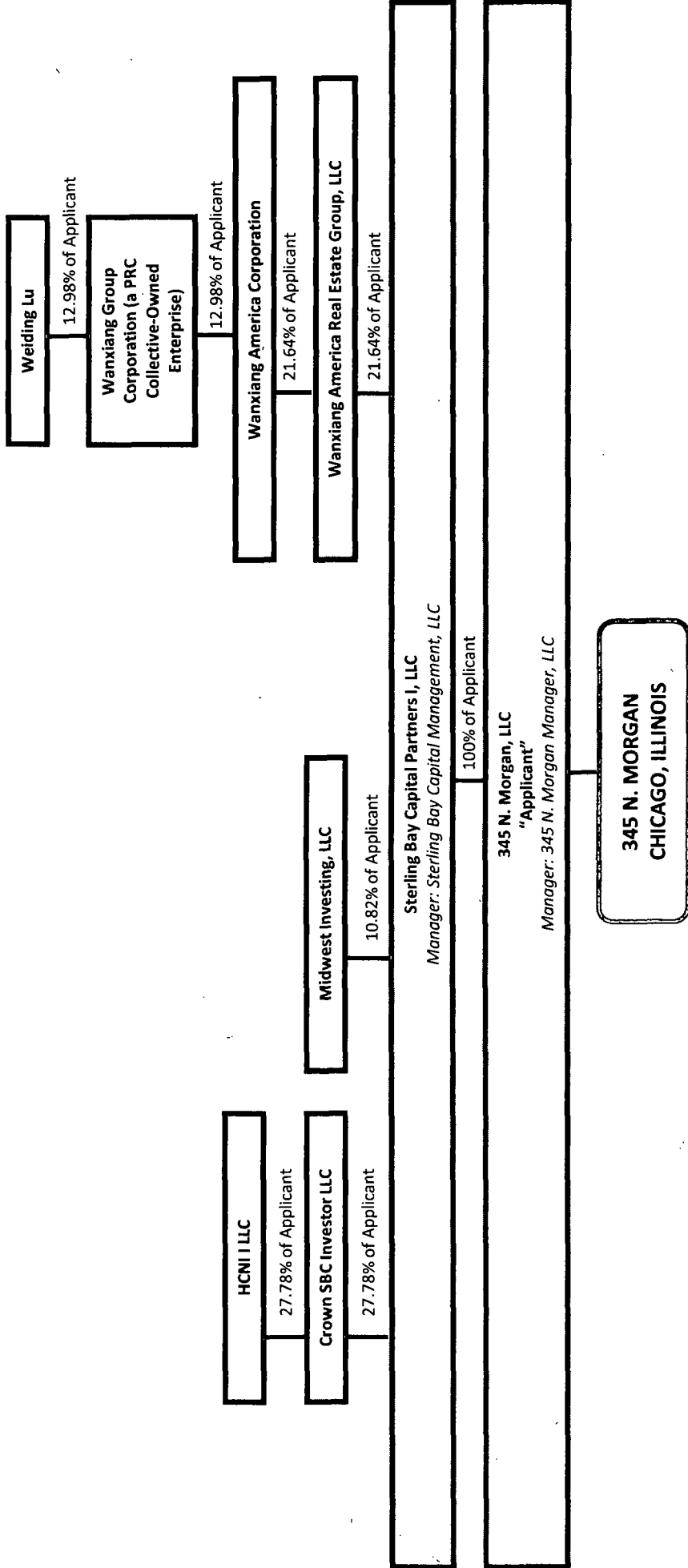

*All entities in blue have a business address of 1330 W. Fulton Street, Suite 800, Chicago, IL 60607; Midwest Investing, LLC has a business address of 7900 Glades Road, Suite 320, Boca Raton, FL 33434, Crown SBC Investor LLC and HCNI I LLC each have a business address of 222 N. LaSalle St., Suite 2000, Chicago, IL 60601; Wanyang America Real Estate Group, LLC has a business address of 150 N. Riverside Plaza, Suite 1810, Chicago, IL 60606; Wanyang America Corporation has a business address of 88 Airport Rd., Elgin, IL 60123; Wanyang Group Corporation has a business address of Xiaoshan Economic and Technological Development Zone, Hanzhou, Zhejiang Province, The People's Republic of China

AUTHORIZATION

The undersigned, Carpenter Carroll LLC, an Illinois limited liability company, being the owner of real property located generally at 1000 West Carroll in Chicago, Illinois (the "**Subject Property**"), hereby authorizes 345 N. Morgan, LLC, a Delaware limited liability company, and any affiliate or designee thereof and its attorneys, DLA Piper LLP (US), to file one or more applications for zoning approvals and related permits and approvals with the City of Chicago relating to the Subject Property.

IN WITNESS WHEREOF, the undersigned has executed this Authorization as of this 20 day of February, 2019.

CARPENTER CARROLL LLC, an Illinois
limited liability company

By: Susan Milligan
Name: Susan Milligan
Its: Manager

**CITY OF CHICAGO
ECONOMIC DISCLOSURE STATEMENT
AND AFFIDAVIT**

SECTION I -- GENERAL INFORMATION

A. Legal name of the Disclosing Party submitting this EDS. Include d/b/a/ if applicable:

345 N. MORGAN, LLC

Check ONE of the following three boxes:

Indicate whether the Disclosing Party submitting this EDS is:

1. the Applicant

OR

2. a legal entity currently holding, or anticipated to hold within six months after City action on the contract, transaction or other undertaking to which this EDS pertains (referred to below as the "Matter"), a direct or indirect interest in excess of 7.5% in the Applicant. State the Applicant's legal name: _____

OR

3. a legal entity with a direct or indirect right of control of the Applicant (see Section II(B)(1)) State the legal name of the entity in which the Disclosing Party holds a right of control: _____

B. Business address of the Disclosing Party: 1330 W. FULTON ST., SUITE 800
CHICAGO, IL 60607

C. Telephone: 312-466-4142 Fax: 312-874-7008 Email: asimpson@sterlingbay.com

D. Name of contact person: Anna Simpson

E. Federal Employer Identification No. (if you have one): _____

F. Brief description of the Matter to which this EDS pertains. (Include project number and location of property, if applicable):
Application for planned development for property located at 345 N. Morgan St., 311 N. Morgan St., and 1000 W. Carroll, Chicago, IL

G. Which City agency or department is requesting this EDS? DPD

If the Matter is a contract being handled by the City's Department of Procurement Services, please complete the following:

Specification # N/A and Contract # N/A

SECTION II -- DISCLOSURE OF OWNERSHIP INTERESTS

A. NATURE OF THE DISCLOSING PARTY

1. Indicate the nature of the Disclosing Party:

- Person
- Limited liability company
- Publicly registered business corporation
- Limited liability partnership
- Privately held business corporation
- Joint venture
- Sole proprietorship
- Not-for-profit corporation
- General partnership
- (Is the not-for-profit corporation also a 501(c)(3))?
- Limited partnership
- Yes No
- Trust
- Other (please specify)

2. For legal entities, the state (or foreign country) of incorporation or organization, if applicable:

DELAWARE

3. For legal entities not organized in the State of Illinois: Has the organization registered to do business in the State of Illinois as a foreign entity?

- Yes
- No
- Organized in Illinois

B. IF THE DISCLOSING PARTY IS A LEGAL ENTITY:

1. List below the full names and titles, if applicable, of: (i) all executive officers and all directors of the entity; (ii) **for not-for-profit corporations**, all members, if any, which are legal entities (if there are no such members, write "no members which are legal entities"); (iii) **for trusts, estates or other similar entities**, the trustee, executor, administrator, or similarly situated party; (iv) **for general or limited partnerships, limited liability companies, limited liability partnerships or joint ventures**, each general partner, managing member, manager or any other person or legal entity that directly or indirectly controls the day-to-day management of the Applicant.

NOTE: Each legal entity listed below must submit an EDS on its own behalf.

Name	Title
345 N. MORGAN MANAGER, LLC-	MANAGER OF APPLICANT
STERLING BAY CAPITAL MANAGEMENT, LLC-	MANAGER OF 345 N. MORGAN MANAGER, LLC
ANDREW GLOOR-	SOLE MANAGER OF STERLING BAY CAPITAL MANAGEMENT, LLC

2. Please provide the following information concerning each person or legal entity having a direct or indirect, current or prospective (i.e. within 6 months after City action) beneficial interest (including ownership) in excess of 7.5% of the Applicant. Examples of such an interest include shares in a corporation, partnership interest in a partnership or joint venture, interest of a member or manager in a

limited liability company, or interest of a beneficiary of a trust, estate or other similar entity. If none, state "None."

NOTE: Each legal entity listed below may be required to submit an EDS on its own behalf.

Name	Business Address	Percentage Interest in the Applicant
PLEASE SEE ATTACHED EXHIBIT A		

SECTION III -- INCOME OR COMPENSATION TO, OR OWNERSHIP BY, CITY ELECTED OFFICIALS

Has the Disclosing Party provided any income or compensation to any City elected official during the 12-month period preceding the date of this EDS? Yes No

Does the Disclosing Party reasonably expect to provide any income or compensation to any City elected official during the 12-month period following the date of this EDS? Yes No

If "yes" to either of the above, please identify below the name(s) of such City elected official(s) and describe such income or compensation:

Does any City elected official or, to the best of the Disclosing Party's knowledge after reasonable inquiry, any City elected official's spouse or domestic partner, have a financial interest (as defined in Chapter 2-156 of the Municipal Code of Chicago ("MCC")) in the Disclosing Party? Yes No

If "yes," please identify below the name(s) of such City elected official(s) and/or spouse(s)/domestic partner(s) and describe the financial interest(s).

SECTION IV -- DISCLOSURE OF SUBCONTRACTORS AND OTHER RETAINED PARTIES

The Disclosing Party must disclose the name and business address of each subcontractor, attorney, lobbyist (as defined in MCC Chapter 2-156), accountant, consultant and any other person or entity whom the Disclosing Party has retained or expects to retain in connection with the Matter, as well as the nature of the relationship, and the total amount of the fees paid or estimated to be paid. The Disclosing Party is not required to disclose employees who are paid solely through the Disclosing Party's regular payroll. If the Disclosing Party is uncertain whether a disclosure is required under this Section, the Disclosing Party must either ask the City whether disclosure is required or make the disclosure.

Name (indicate whether retained or anticipated to be retained)	Business Address	Relationship to Disclosing Party (subcontractor, attorney, lobbyist, etc.)	Fees (<u>indicate whether paid or estimated.</u>) NOTE: "hourly rate" or "t.b.d." is not an acceptable response.
DLA Piper LLP (US)- retained-	444 W. Lake Street, Suite 900,	Chicago, IL 60606-	attorney- estimated \$25,000+
Kenig, Lindgren, O'Hara, Aboona, Inc.-retained-	9575 W. Higgins Rd., Ste 400,	Rosemont, IL 60018-	traffic analysis- estimated fees \$16,000

(Add sheets if necessary)

Check here if the Disclosing Party has not retained, nor expects to retain, any such persons or entities.

SECTION V -- CERTIFICATIONS

A. COURT-ORDERED CHILD SUPPORT COMPLIANCE

Under MCC Section 2-92-415, substantial owners of business entities that contract with the City must remain in compliance with their child support obligations throughout the contract's term.

Has any person who directly or indirectly owns 10% or more of the Disclosing Party been declared in arrearage on any child support obligations by any Illinois court of competent jurisdiction?

Yes No No person directly or indirectly owns 10% or more of the Disclosing Party.

If "Yes," has the person entered into a court-approved agreement for payment of all support owed and is the person in compliance with that agreement?

Yes No

B. FURTHER CERTIFICATIONS

1. [This paragraph 1 applies only if the Matter is a contract being handled by the City's Department of Procurement Services.] In the 5-year period preceding the date of this EDS, neither the Disclosing Party nor any Affiliated Entity [see definition in (5) below] has engaged, in connection with the performance of any public contract, the services of an integrity monitor, independent private sector inspector general, or integrity compliance consultant (i.e., an individual or entity with legal, auditing, investigative, or other similar skills, designated by a public agency to help the agency monitor the activity of specified agency vendors as well as help the vendors reform their business practices so they can be considered for agency contracts in the future, or continue with a contract in progress).

2. The Disclosing Party and its Affiliated Entities are not delinquent in the payment of any fine, fee, tax or other source of indebtedness owed to the City of Chicago, including, but not limited to, water and sewer charges, license fees, parking tickets, property taxes and sales taxes, nor is the Disclosing Party delinquent in the payment of any tax administered by the Illinois Department of Revenue.

3. The Disclosing Party and, if the Disclosing Party is a legal entity, all of those persons or entities identified in Section II(B)(1) of this EDS:

- a. are not presently debarred, suspended, proposed for debarment, declared ineligible or voluntarily excluded from any transactions by any federal, state or local unit of government;
- b. have not, during the 5 years before the date of this EDS, been convicted of a criminal offense, adjudged guilty, or had a civil judgment rendered against them in connection with: obtaining, attempting to obtain, or performing a public (federal, state or local) transaction or contract under a public transaction; a violation of federal or state antitrust statutes; fraud; embezzlement; theft; forgery; bribery; falsification or destruction of records; making false statements; or receiving stolen property;
- c. are not presently indicted for, or criminally or civilly charged by, a governmental entity (federal, state or local) with committing any of the offenses set forth in subparagraph (b) above;
- d. have not, during the 5 years before the date of this EDS, had one or more public transactions (federal, state or local) terminated for cause or default; and
- e. have not, during the 5 years before the date of this EDS, been convicted, adjudged guilty, or found liable in a civil proceeding, or in any criminal or civil action, including actions concerning environmental violations, instituted by the City or by the federal government, any state, or any other unit of local government.

4. The Disclosing Party understands and shall comply with the applicable requirements of MCC Chapters 2-56 (Inspector General) and 2-156 (Governmental Ethics).

5. Certifications (5), (6) and (7) concern:

- the Disclosing Party;
- any "Contractor" (meaning any contractor or subcontractor used by the Disclosing Party in connection with the Matter, including but not limited to all persons or legal entities disclosed under Section IV, "Disclosure of Subcontractors and Other Retained Parties");
- any "Affiliated Entity" (meaning a person or entity that, directly or indirectly: controls the Disclosing Party, is controlled by the Disclosing Party, or is, with the Disclosing Party, under common control of another person or entity). Indicia of control include, without limitation: interlocking management or ownership; identity of interests among family members, shared facilities and equipment; common use of employees; or organization of a business entity following the ineligibility of a business entity to do business with federal or state or local government, including the City, using substantially the same management, ownership, or principals as the ineligible entity. With respect to Contractors, the term Affiliated Entity means a person or entity that directly or indirectly controls the Contractor, is controlled by it, or, with the Contractor, is under common control of another person or entity;
- any responsible official of the Disclosing Party, any Contractor or any Affiliated Entity or any other official, agent or employee of the Disclosing Party, any Contractor or any Affiliated Entity, acting pursuant to the direction or authorization of a responsible official of the Disclosing Party, any Contractor or any Affiliated Entity (collectively "Agents").

Neither the Disclosing Party, nor any Contractor, nor any Affiliated Entity of either the Disclosing Party or any Contractor, nor any Agents have, during the 5 years before the date of this EDS, or, with respect to a Contractor, an Affiliated Entity, or an Affiliated Entity of a Contractor during the 5 years before the date of such Contractor's or Affiliated Entity's contract or engagement in connection with the Matter:

- a. bribed or attempted to bribe, or been convicted or adjudged guilty of bribery or attempting to bribe, a public officer or employee of the City, the State of Illinois, or any agency of the federal government or of any state or local government in the United States of America, in that officer's or employee's official capacity;
 - b. agreed or colluded with other bidders or prospective bidders, or been a party to any such agreement, or been convicted or adjudged guilty of agreement or collusion among bidders or prospective bidders, in restraint of freedom of competition by agreement to bid a fixed price or otherwise; or
 - c. made an admission of such conduct described in subparagraph (a) or (b) above that is a matter of record, but have not been prosecuted for such conduct; or
 - d. violated the provisions referenced in MCC Subsection 2-92-320(a)(4)(Contracts Requiring a Base Wage); (a)(5)(Debarment Regulations); or (a)(6)(Minimum Wage Ordinance).
6. Neither the Disclosing Party, nor any Affiliated Entity or Contractor, or any of their employees, officials, agents or partners, is barred from contracting with any unit of state or local government as a result of engaging in or being convicted of (1) bid-rigging in violation of 720 ILCS 5/33E-3; (2) bid-rotating in violation of 720 ILCS 5/33E-4; or (3) any similar offense of any state or of the United States of America that contains the same elements as the offense of bid-rigging or bid-rotating.
7. Neither the Disclosing Party nor any Affiliated Entity is listed on a Sanctions List maintained by the United States Department of Commerce, State, or Treasury, or any successor federal agency.
8. [FOR APPLICANT ONLY] (i) Neither the Applicant nor any "controlling person" [see MCC Chapter 1-23, Article I for applicability and defined terms] of the Applicant is currently indicted or charged with, or has admitted guilt of, or has ever been convicted of, or placed under supervision for, any criminal offense involving actual, attempted, or conspiracy to commit bribery, theft, fraud, forgery, perjury, dishonesty or deceit against an officer or employee of the City or any "sister agency"; and (ii) the Applicant understands and acknowledges that compliance with Article I is a continuing requirement for doing business with the City. NOTE: If MCC Chapter 1-23, Article I applies to the Applicant, that Article's permanent compliance timeframe supersedes 5-year compliance timeframes in this Section V.
9. [FOR APPLICANT ONLY] The Applicant and its Affiliated Entities will not use, nor permit their subcontractors to use, any facility listed as having an active exclusion by the U.S. EPA on the federal System for Award Management ("SAM").
10. [FOR APPLICANT ONLY] The Applicant will obtain from any contractors/subcontractors hired or to be hired in connection with the Matter certifications equal in form and substance to those in Certifications (2) and (9) above and will not, without the prior written consent of the City, use any such

contractor/subcontractor that does not provide such certifications or that the Applicant has reason to believe has not provided or cannot provide truthful certifications.

11. If the Disclosing Party is unable to certify to any of the above statements in this Part B (Further Certifications), the Disclosing Party must explain below:

N/A

If the letters "NA," the word "None," or no response appears on the lines above, it will be conclusively presumed that the Disclosing Party certified to the above statements.

12. To the best of the Disclosing Party's knowledge after reasonable inquiry, the following is a complete list of all current employees of the Disclosing Party who were, at any time during the 12-month period preceding the date of this EDS, an employee, or elected or appointed official, of the City of Chicago (if none, indicate with "N/A" or "none").

N/A

13. To the best of the Disclosing Party's knowledge after reasonable inquiry, the following is a complete list of all gifts that the Disclosing Party has given or caused to be given, at any time during the 12-month period preceding the execution date of this EDS, to an employee, or elected or appointed official, of the City of Chicago. For purposes of this statement, a "gift" does not include: (i) anything made generally available to City employees or to the general public, or (ii) food or drink provided in the course of official City business and having a retail value of less than \$25 per recipient, or (iii) a political contribution otherwise duly reported as required by law (if none, indicate with "N/A" or "none"). As to any gift listed below, please also list the name of the City recipient.

N/A

C. CERTIFICATION OF STATUS AS FINANCIAL INSTITUTION

1. The Disclosing Party certifies that the Disclosing Party (check one)

is is not

a "financial institution" as defined in MCC Section 2-32-455(b).

2. If the Disclosing Party IS a financial institution, then the Disclosing Party pledges:

"We are not and will not become a predatory lender as defined in MCC Chapter 2-32. We further pledge that none of our affiliates is, and none of them will become, a predatory lender as defined in MCC Chapter 2-32. We understand that becoming a predatory lender or becoming an affiliate of a predatory lender may result in the loss of the privilege of doing business with the City."

If the Disclosing Party is unable to make this pledge because it or any of its affiliates (as defined in MCC Section 2-32-455(b)) is a predatory lender within the meaning of MCC Chapter 2-32, explain here (attach additional pages if necessary):

If the letters "NA," the word "None," or no response appears on the lines above, it will be conclusively presumed that the Disclosing Party certified to the above statements.

D. CERTIFICATION REGARDING FINANCIAL INTEREST IN CITY BUSINESS

Any words or terms defined in MCC Chapter 2-156 have the same meanings if used in this Part D.

1. In accordance with MCC Section 2-156-110: To the best of the Disclosing Party's knowledge after reasonable inquiry, does any official or employee of the City have a financial interest in his or her own name or in the name of any other person or entity in the Matter?

Yes No

NOTE: If you checked "Yes" to Item D(1), proceed to Items D(2) and D(3). If you checked "No" to Item D(1), skip Items D(2) and D(3) and proceed to Part E.

2. Unless sold pursuant to a process of competitive bidding, or otherwise permitted, no City elected official or employee shall have a financial interest in his or her own name or in the name of any other person or entity in the purchase of any property that (i) belongs to the City, or (ii) is sold for taxes or assessments, or (iii) is sold by virtue of legal process at the suit of the City (collectively, "City Property Sale"). Compensation for property taken pursuant to the City's eminent domain power does not constitute a financial interest within the meaning of this Part D.

Does the Matter involve a City Property Sale?

Yes No

3. If you checked "Yes" to Item D(1), provide the names and business addresses of the City officials or employees having such financial interest and identify the nature of the financial interest:

Name	Business Address	Nature of Financial Interest
------	------------------	------------------------------

4. The Disclosing Party further certifies that no prohibited financial interest in the Matter will be acquired by any City official or employee.

E. CERTIFICATION REGARDING SLAVERY ERA BUSINESS

Please check either (1) or (2) below. If the Disclosing Party checks (2), the Disclosing Party must disclose below or in an attachment to this EDS all information required by (2). Failure to comply with these disclosure requirements may make any contract entered into with the City in connection with the Matter voidable by the City.

X 1. The Disclosing Party verifies that the Disclosing Party has searched any and all records of the Disclosing Party and any and all predecessor entities regarding records of investments or profits from slavery or slaveholder insurance policies during the slavery era (including insurance policies issued to slaveholders that provided coverage for damage to or injury or death of their slaves), and the Disclosing Party has found no such records.

2. The Disclosing Party verifies that, as a result of conducting the search in step (1) above, the Disclosing Party has found records of investments or profits from slavery or slaveholder insurance policies. The Disclosing Party verifies that the following constitutes full disclosure of all such records, including the names of any and all slaves or slaveholders described in those records:

SECTION VI -- CERTIFICATIONS FOR FEDERALLY FUNDED MATTERS

NOTE: If the Matter is federally funded, complete this Section VI. **If the Matter is not federally funded**, proceed to Section VII. For purposes of this Section VI, tax credits allocated by the City and proceeds of debt obligations of the City are not federal funding.

A. CERTIFICATION REGARDING LOBBYING

1. List below the names of all persons or entities registered under the federal Lobbying Disclosure Act of 1995, as amended, who have made lobbying contacts on behalf of the Disclosing Party with respect to the Matter: (Add sheets if necessary):

(If no explanation appears or begins on the lines above, or if the letters "NA" or if the word "None" appear, it will be conclusively presumed that the Disclosing Party means that NO persons or entities registered under the Lobbying Disclosure Act of 1995, as amended, have made lobbying contacts on behalf of the Disclosing Party with respect to the Matter.)

2. The Disclosing Party has not spent and will not expend any federally appropriated funds to pay any person or entity listed in paragraph A(1) above for his or her lobbying activities or to pay any person or entity to influence or attempt to influence an officer or employee of any agency, as defined by applicable federal law, a member of Congress, an officer or employee of Congress, or an employee

of a member of Congress, in connection with the award of any federally funded contract, making any federally funded grant or loan, entering into any cooperative agreement, or to extend, continue, renew, amend, or modify any federally funded contract, grant, loan, or cooperative agreement.

3. The Disclosing Party will submit an updated certification at the end of each calendar quarter in which there occurs any event that materially affects the accuracy of the statements and information set forth in paragraphs A(1) and A(2) above.

4. The Disclosing Party certifies that either: (i) it is not an organization described in section 501(c)(4) of the Internal Revenue Code of 1986; or (ii) it is an organization described in section 501(c)(4) of the Internal Revenue Code of 1986 but has not engaged and will not engage in "Lobbying Activities," as that term is defined in the Lobbying Disclosure Act of 1995, as amended.

5. If the Disclosing Party is the Applicant, the Disclosing Party must obtain certifications equal in form and substance to paragraphs A(1) through A(4) above from all subcontractors before it awards any subcontract and the Disclosing Party must maintain all such subcontractors' certifications for the duration of the Matter and must make such certifications promptly available to the City upon request.

B. CERTIFICATION REGARDING EQUAL EMPLOYMENT OPPORTUNITY

If the Matter is federally funded, federal regulations require the Applicant and all proposed subcontractors to submit the following information with their bids or in writing at the outset of negotiations.

Is the Disclosing Party the Applicant?

Yes No

If "Yes," answer the three questions below:

1. Have you developed and do you have on file affirmative action programs pursuant to applicable federal regulations? (See 41 CFR Part 60-2.)

Yes No

2. Have you filed with the Joint Reporting Committee, the Director of the Office of Federal Contract Compliance Programs, or the Equal Employment Opportunity Commission all reports due under the applicable filing requirements?

Yes No Reports not required

3. Have you participated in any previous contracts or subcontracts subject to the equal opportunity clause?

Yes No

If you checked "No" to question (1) or (2) above, please provide an explanation:

SECTION VII -- FURTHER ACKNOWLEDGMENTS AND CERTIFICATION

The Disclosing Party understands and agrees that:

A. The certifications, disclosures, and acknowledgments contained in this EDS will become part of any contract or other agreement between the Applicant and the City in connection with the Matter, whether procurement, City assistance, or other City action, and are material inducements to the City's execution of any contract or taking other action with respect to the Matter. The Disclosing Party understands that it must comply with all statutes, ordinances, and regulations on which this EDS is based.

B. The City's Governmental Ethics Ordinance, MCC Chapter 2-156, imposes certain duties and obligations on persons or entities seeking City contracts, work, business, or transactions. The full text of this ordinance and a training program is available on line at www.cityofchicago.org/Ethics, and may also be obtained from the City's Board of Ethics, 740 N. Sedgwick St., Suite 500, Chicago, IL 60610, (312) 744-9660. The Disclosing Party must comply fully with this ordinance.

C. If the City determines that any information provided in this EDS is false, incomplete or inaccurate, any contract or other agreement in connection with which it is submitted may be rescinded or be void or voidable, and the City may pursue any remedies under the contract or agreement (if not rescinded or void), at law, or in equity, including terminating the Disclosing Party's participation in the Matter and/or declining to allow the Disclosing Party to participate in other City transactions. Remedies at law for a false statement of material fact may include incarceration and an award to the City of treble damages.

D. It is the City's policy to make this document available to the public on its Internet site and/or upon request. Some or all of the information provided in, and appended to, this EDS may be made publicly available on the Internet, in response to a Freedom of Information Act request, or otherwise. By completing and signing this EDS, the Disclosing Party waives and releases any possible rights or claims which it may have against the City in connection with the public release of information contained in this EDS and also authorizes the City to verify the accuracy of any information submitted in this EDS.

E. The information provided in this EDS must be kept current. In the event of changes, the Disclosing Party must supplement this EDS up to the time the City takes action on the Matter. If the Matter is a contract being handled by the City's Department of Procurement Services, the Disclosing Party must update this EDS as the contract requires. **NOTE:** With respect to Matters subject to MCC Chapter 1-23, Article I (imposing **PERMANENT INELIGIBILITY** for certain specified offenses), the information provided herein regarding eligibility must be kept current for a longer period, as required by MCC Chapter 1-23 and Section 2-154-020.

CERTIFICATION

Under penalty of perjury, the person signing below: (1) warrants that he/she is authorized to execute this EDS, and all applicable Appendices, on behalf of the Disclosing Party, and (2) warrants that all certifications and statements contained in this EDS, and all applicable Appendices, are true, accurate and complete as of the date furnished to the City.

345 N. MORGAN, LLC
(Print or type exact legal name of Disclosing Party)

By: _____
(Sign here)

ANDREW GLOOR
(Print or type name of person signing)

Sole Manager of Sterling Bay Capital Management, LLC, manager of 345 N. Morgan Manager, LLC, manager of 345 N. Morgan, LLC

(Print or type title of person signing)

Signed and sworn to before me on (date) 2/26/19,

at COOK County, ILLINOIS (state).

[Signature]
Notary Public

Commission expires: 2/2/22

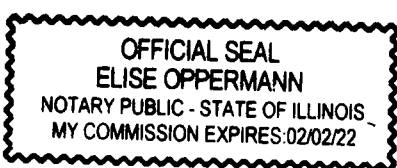

OFFICIAL USE
FBI LABORATORY
WASHINGTON, D.C. 20535

**CITY OF CHICAGO
ECONOMIC DISCLOSURE STATEMENT AND AFFIDAVIT
APPENDIX A**

**FAMILIAL RELATIONSHIPS WITH ELECTED CITY OFFICIALS
AND DEPARTMENT HEADS**

This Appendix is to be completed only by (a) the Applicant, and (b) any legal entity which has a direct ownership interest in the Applicant exceeding 7.5%. It is not to be completed by any legal entity which has only an indirect ownership interest in the Applicant.

Under MCC Section 2-154-015, the Disclosing Party must disclose whether such Disclosing Party or any "Applicable Party" or any Spouse or Domestic Partner thereof currently has a "familial relationship" with any elected city official or department head. A "familial relationship" exists if, as of the date this EDS is signed, the Disclosing Party or any "Applicable Party" or any Spouse or Domestic Partner thereof is related to the mayor, any alderman, the city clerk, the city treasurer or any city department head as spouse or domestic partner or as any of the following, whether by blood or adoption: parent, child, brother or sister, aunt or uncle, niece or nephew, grandparent, grandchild, father-in-law, mother-in-law, son-in-law, daughter-in-law, stepfather or stepmother, stepson or stepdaughter, stepbrother or stepsister or half-brother or half-sister.

"Applicable Party" means (1) all executive officers of the Disclosing Party listed in Section II.B.1.a., if the Disclosing Party is a corporation; all partners of the Disclosing Party, if the Disclosing Party is a general partnership; all general partners and limited partners of the Disclosing Party, if the Disclosing Party is a limited partnership; all managers, managing members and members of the Disclosing Party, if the Disclosing Party is a limited liability company; (2) all principal officers of the Disclosing Party; and (3) any person having more than a 7.5% ownership interest in the Disclosing Party. "Principal officers" means the president, chief operating officer, executive director, chief financial officer, treasurer or secretary of a legal entity or any person exercising similar authority.

Does the Disclosing Party or any "Applicable Party" or any Spouse or Domestic Partner thereof currently have a "familial relationship" with an elected city official or department head?

Yes

No

If yes, please identify below (1) the name and title of such person, (2) the name of the legal entity to which such person is connected; (3) the name and title of the elected city official or department head to whom such person has a familial relationship, and (4) the precise nature of such familial relationship.

**CITY OF CHICAGO
ECONOMIC DISCLOSURE STATEMENT AND AFFIDAVIT
APPENDIX B**

BUILDING CODE SCOFFLAW/PROBLEM LANDLORD CERTIFICATION

This Appendix is to be completed only by (a) the Applicant, and (b) any legal entity which has a direct ownership interest in the Applicant exceeding 7.5% (an "Owner"). It is not to be completed by any legal entity which has only an indirect ownership interest in the Applicant.

1. Pursuant to MCC Section 2-154-010, is the Applicant or any Owner identified as a building code scofflaw or problem landlord pursuant to MCC Section 2-92-416?

Yes No

2. If the Applicant is a legal entity publicly traded on any exchange, is any officer or director of the Applicant identified as a building code scofflaw or problem landlord pursuant to MCC Section 2-92-416?

Yes No The Applicant is not publicly traded on any exchange.

3. If yes to (1) or (2) above, please identify below the name of each person or legal entity identified as a building code scofflaw or problem landlord and the address of each building or buildings to which the pertinent code violations apply.

**CITY OF CHICAGO
ECONOMIC DISCLOSURE STATEMENT AND AFFIDAVIT
APPENDIX C**

PROHIBITION ON WAGE & SALARY HISTORY SCREENING - CERTIFICATION

This Appendix is to be completed only by an Applicant that is completing this EDS as a “contractor” as defined in MCC Section 2-92-385. That section, which should be consulted (www.amlegal.com), generally covers a party to any agreement pursuant to which they: (i) receive City of Chicago funds in consideration for services, work or goods provided (including for legal or other professional services), or (ii) pay the City money for a license, grant or concession allowing them to conduct a business on City premises.

On behalf of an Applicant that is a contractor pursuant to MCC Section 2-92-385, I hereby certify that the Applicant is in compliance with MCC Section 2-92-385(b)(1) and (2), which prohibit: (i) screening job applicants based on their wage or salary history, or (ii) seeking job applicants’ wage or salary history from current or former employers. I also certify that the Applicant has adopted a policy that includes those prohibitions.

Yes

No

N/A – I am not an Applicant that is a “contractor” as defined in MCC Section 2-92-385.

This certification shall serve as the affidavit required by MCC Section 2-92-385(c)(1).

If you checked “no” to the above, please explain.

**CITY OF CHICAGO
ECONOMIC DISCLOSURE STATEMENT
AND AFFIDAVIT**

SECTION I -- GENERAL INFORMATION

A. Legal name of the Disclosing Party submitting this EDS. Include d/b/a/ if applicable:
STERLING BAY CAPITAL PARTNERS I, LLC

Check ONE of the following three boxes:

Indicate whether the Disclosing Party submitting this EDS is:

1. the Applicant
OR

2. a legal entity currently holding, or anticipated to hold within six months after City action on the contract, transaction or other undertaking to which this EDS pertains (referred to below as the "Matter"), a direct or indirect interest in excess of 7.5% in the Applicant. State the Applicant's legal name: 345 N. MORGAN, LLC

OR

3. a legal entity with a direct or indirect right of control of the Applicant (see Section II(B)(1))
State the legal name of the entity in which the Disclosing Party holds a right of control:

B. Business address of the Disclosing Party: 1330 W. FULTON ST., SUITE 800
CHICAGO, IL 60607

C. Telephone: 312-466-4142 Fax: 312-874-7008 Email: asimpson@sterlingbay.com

D. Name of contact person: Anna Simpson

E. Federal Employer Identification No. (if you have one): _____

F. Brief description of the Matter to which this EDS pertains. (Include project number and location of property, if applicable):

Application for Planned Development for property commonly known as 345 N. Morgan St., 311 N. Morgan St., and 1000 W. Carroll Ave., Chicago, IL

G. Which City agency or department is requesting this EDS? DPD

If the Matter is a contract being handled by the City's Department of Procurement Services, please complete the following:

Specification # N/A and Contract # N/A

SECTION II -- DISCLOSURE OF OWNERSHIP INTERESTS

A. NATURE OF THE DISCLOSING PARTY

1. Indicate the nature of the Disclosing Party:

- Person
 - Publicly registered business corporation
 - Privately held business corporation
 - Sole proprietorship
 - General partnership
 - Limited partnership
 - Trust
 - Limited liability company
 - Limited liability partnership
 - Joint venture
 - Not-for-profit corporation
- (Is the not-for-profit corporation also a 501(c)(3))?
 Yes No
 Other (please specify)

2. For legal entities, the state (or foreign country) of incorporation or organization, if applicable:

Delaware

3. For legal entities not organized in the State of Illinois: Has the organization registered to do business in the State of Illinois as a foreign entity?

- Yes
- No
- Organized in Illinois

B. IF THE DISCLOSING PARTY IS A LEGAL ENTITY:

1. List below the full names and titles, if applicable, of: (i) all executive officers and all directors of the entity; (ii) **for not-for-profit corporations**, all members, if any, which are legal entities (if there are no such members, write "no members which are legal entities"); (iii) **for trusts, estates or other similar entities**, the trustee, executor, administrator, or similarly situated party; (iv) **for general or limited partnerships, limited liability companies, limited liability partnerships or joint ventures**, each general partner, managing member, manager or any other person or legal entity that directly or indirectly controls the day-to-day management of the Applicant.

NOTE: Each legal entity listed below must submit an EDS on its own behalf.

Name	Title
Please refer to Applicant EDS	

2. Please provide the following information concerning each person or legal entity having a direct or indirect, current or prospective (i.e. within 6 months after City action) beneficial interest (including ownership) in excess of 7.5% of the Applicant. Examples of such an interest include shares in a corporation, partnership interest in a partnership or joint venture, interest of a member or manager in a

limited liability company, or interest of a beneficiary of a trust, estate or other similar entity. If none, state "None."

NOTE: Each legal entity listed below may be required to submit an EDS on its own behalf.

Name	Business Address	Percentage Interest in the Applicant
Please see attached Exhibit A		

SECTION III -- INCOME OR COMPENSATION TO, OR OWNERSHIP BY, CITY ELECTED OFFICIALS

Has the Disclosing Party provided any income or compensation to any City elected official during the 12-month period preceding the date of this EDS? Yes No

Does the Disclosing Party reasonably expect to provide any income or compensation to any City elected official during the 12-month period following the date of this EDS? Yes No

If "yes" to either of the above, please identify below the name(s) of such City elected official(s) and describe such income or compensation:

Does any City elected official or, to the best of the Disclosing Party's knowledge after reasonable inquiry, any City elected official's spouse or domestic partner, have a financial interest (as defined in Chapter 2-156 of the Municipal Code of Chicago ("MCC")) in the Disclosing Party?

Yes No

If "yes," please identify below the name(s) of such City elected official(s) and/or spouse(s)/domestic partner(s) and describe the financial interest(s).

SECTION IV -- DISCLOSURE OF SUBCONTRACTORS AND OTHER RETAINED PARTIES

The Disclosing Party must disclose the name and business address of each subcontractor, attorney, lobbyist (as defined in MCC Chapter 2-156), accountant, consultant and any other person or entity whom the Disclosing Party has retained or expects to retain in connection with the Matter, as well as the nature of the relationship, and the total amount of the fees paid or estimated to be paid. The Disclosing Party is not required to disclose employees who are paid solely through the Disclosing Party's regular payroll. If the Disclosing Party is uncertain whether a disclosure is required under this Section, the Disclosing Party must either ask the City whether disclosure is required or make the disclosure.

Name (indicate whether retained or anticipated to be retained)	Business Address	Relationship to Disclosing Party (subcontractor, attorney, lobbyist, etc.)	Fees (<u>indicate whether paid or estimated.</u>) NOTE: "hourly rate" or "t.b.d." is not an acceptable response.
--	------------------	--	---

(Add sheets if necessary)

Check here if the Disclosing Party has not retained, nor expects to retain, any such persons or entities.

SECTION V -- CERTIFICATIONS

A. COURT-ORDERED CHILD SUPPORT COMPLIANCE

Under MCC Section 2-92-415, substantial owners of business entities that contract with the City must remain in compliance with their child support obligations throughout the contract's term.

Has any person who directly or indirectly owns 10% or more of the Disclosing Party been declared in arrearage on any child support obligations by any Illinois court of competent jurisdiction?

Yes No No person directly or indirectly owns 10% or more of the Disclosing Party.

If "Yes," has the person entered into a court-approved agreement for payment of all support owed and is the person in compliance with that agreement?

Yes No

B. FURTHER CERTIFICATIONS

1. [This paragraph 1 applies only if the Matter is a contract being handled by the City's Department of Procurement Services.] In the 5-year period preceding the date of this EDS, neither the Disclosing Party nor any Affiliated Entity [see definition in (5) below] has engaged, in connection with the performance of any public contract, the services of an integrity monitor, independent private sector inspector general, or integrity compliance consultant (i.e., an individual or entity with legal, auditing, investigative, or other similar skills, designated by a public agency to help the agency monitor the activity of specified agency vendors as well as help the vendors reform their business practices so they can be considered for agency contracts in the future, or continue with a contract in progress).

2. The Disclosing Party and its Affiliated Entities are not delinquent in the payment of any fine, fee, tax or other source of indebtedness owed to the City of Chicago, including, but not limited to, water and sewer charges, license fees, parking tickets, property taxes and sales taxes, nor is the Disclosing Party delinquent in the payment of any tax administered by the Illinois Department of Revenue.

3. The Disclosing Party and, if the Disclosing Party is a legal entity, all of those persons or entities identified in Section II(B)(1) of this EDS:

- a. are not presently debarred, suspended, proposed for debarment, declared ineligible or voluntarily excluded from any transactions by any federal, state or local unit of government;
- b. have not, during the 5 years before the date of this EDS, been convicted of a criminal offense, adjudged guilty, or had a civil judgment rendered against them in connection with: obtaining, attempting to obtain, or performing a public (federal, state or local) transaction or contract under a public transaction; a violation of federal or state antitrust statutes; fraud; embezzlement; theft; forgery; bribery; falsification or destruction of records; making false statements; or receiving stolen property;
- c. are not presently indicted for, or criminally or civilly charged by, a governmental entity (federal, state or local) with committing any of the offenses set forth in subparagraph (b) above;
- d. have not, during the 5 years before the date of this EDS, had one or more public transactions (federal, state or local) terminated for cause or default; and
- e. have not, during the 5 years before the date of this EDS, been convicted, adjudged guilty, or found liable in a civil proceeding, or in any criminal or civil action, including actions concerning environmental violations, instituted by the City or by the federal government, any state, or any other unit of local government.

4. The Disclosing Party understands and shall comply with the applicable requirements of MCC Chapters 2-56 (Inspector General) and 2-156 (Governmental Ethics).

5. Certifications (5), (6) and (7) concern:

- the Disclosing Party;
- any "Contractor" (meaning any contractor or subcontractor used by the Disclosing Party in connection with the Matter, including but not limited to all persons or legal entities disclosed under Section IV, "Disclosure of Subcontractors and Other Retained Parties");
- any "Affiliated Entity" (meaning a person or entity that, directly or indirectly: controls the Disclosing Party, is controlled by the Disclosing Party, or is, with the Disclosing Party, under common control of another person or entity). Indicia of control include, without limitation: interlocking management or ownership; identity of interests among family members, shared facilities and equipment; common use of employees; or organization of a business entity following the ineligibility of a business entity to do business with federal or state or local government, including the City, using substantially the same management, ownership, or principals as the ineligible entity. With respect to Contractors, the term Affiliated Entity means a person or entity that directly or indirectly controls the Contractor, is controlled by it, or, with the Contractor, is under common control of another person or entity;
- any responsible official of the Disclosing Party, any Contractor or any Affiliated Entity or any other official, agent or employee of the Disclosing Party, any Contractor or any Affiliated Entity, acting pursuant to the direction or authorization of a responsible official of the Disclosing Party, any Contractor or any Affiliated Entity (collectively "Agents").

Neither the Disclosing Party, nor any Contractor, nor any Affiliated Entity of either the Disclosing Party or any Contractor, nor any Agents have, during the 5 years before the date of this EDS, or, with respect to a Contractor, an Affiliated Entity, or an Affiliated Entity of a Contractor during the 5 years before the date of such Contractor's or Affiliated Entity's contract or engagement in connection with the Matter:

a. bribed or attempted to bribe, or been convicted or adjudged guilty of bribery or attempting to bribe, a public officer or employee of the City, the State of Illinois, or any agency of the federal government or of any state or local government in the United States of America, in that officer's or employee's official capacity;

b. agreed or colluded with other bidders or prospective bidders, or been a party to any such agreement, or been convicted or adjudged guilty of agreement or collusion among bidders or prospective bidders, in restraint of freedom of competition by agreement to bid a fixed price or otherwise; or

c. made an admission of such conduct described in subparagraph (a) or (b) above that is a matter of record, but have not been prosecuted for such conduct; or

d. violated the provisions referenced in MCC Subsection 2-92-320(a)(4)(Contracts Requiring a Base Wage); (a)(5)(Debarment Regulations); or (a)(6)(Minimum Wage Ordinance).

6. Neither the Disclosing Party, nor any Affiliated Entity or Contractor, or any of their employees, officials, agents or partners, is barred from contracting with any unit of state or local government as a result of engaging in or being convicted of (1) bid-rigging in violation of 720 ILCS 5/33E-3; (2) bid-rotating in violation of 720 ILCS 5/33E-4; or (3) any similar offense of any state or of the United States of America that contains the same elements as the offense of bid-rigging or bid-rotating.

7. Neither the Disclosing Party nor any Affiliated Entity is listed on a Sanctions List maintained by the United States Department of Commerce, State, or Treasury, or any successor federal agency.

8. [FOR APPLICANT ONLY] (i) Neither the Applicant nor any "controlling person" [see MCC Chapter 1-23, Article I for applicability and defined terms] of the Applicant is currently indicted or charged with, or has admitted guilt of, or has ever been convicted of, or placed under supervision for, any criminal offense involving actual, attempted, or conspiracy to commit bribery, theft, fraud, forgery, perjury, dishonesty or deceit against an officer or employee of the City or any "sister agency"; and (ii) the Applicant understands and acknowledges that compliance with Article I is a continuing requirement for doing business with the City. NOTE: If MCC Chapter 1-23, Article I applies to the Applicant, that Article's permanent compliance timeframe supersedes 5-year compliance timeframes in this Section V.

9. [FOR APPLICANT ONLY] The Applicant and its Affiliated Entities will not use, nor permit their subcontractors to use, any facility listed as having an active exclusion by the U.S. EPA on the federal System for Award Management ("SAM").

10. [FOR APPLICANT ONLY] The Applicant will obtain from any contractors/subcontractors hired or to be hired in connection with the Matter certifications equal in form and substance to those in Certifications (2) and (9) above and will not, without the prior written consent of the City, use any such

contractor/subcontractor that does not provide such certifications or that the Applicant has reason to believe has not provided or cannot provide truthful certifications.

11. If the Disclosing Party is unable to certify to any of the above statements in this Part B (Further Certifications), the Disclosing Party must explain below:

N/A

If the letters "NA," the word "None," or no response appears on the lines above, it will be conclusively presumed that the Disclosing Party certified to the above statements.

12. To the best of the Disclosing Party's knowledge after reasonable inquiry, the following is a complete list of all current employees of the Disclosing Party who were, at any time during the 12-month period preceding the date of this EDS, an employee, or elected or appointed official, of the City of Chicago (if none, indicate with "N/A" or "none").

N/A

13. To the best of the Disclosing Party's knowledge after reasonable inquiry, the following is a complete list of all gifts that the Disclosing Party has given or caused to be given, at any time during the 12-month period preceding the execution date of this EDS, to an employee, or elected or appointed official, of the City of Chicago. For purposes of this statement, a "gift" does not include: (i) anything made generally available to City employees or to the general public, or (ii) food or drink provided in the course of official City business and having a retail value of less than \$25 per recipient, or (iii) a political contribution otherwise duly reported as required by law (if none, indicate with "N/A" or "none"). As to any gift listed below, please also list the name of the City recipient.

N/A

C. CERTIFICATION OF STATUS AS FINANCIAL INSTITUTION

1. The Disclosing Party certifies that the Disclosing Party (check one)

is is not

a "financial institution" as defined in MCC Section 2-32-455(b).

2. If the Disclosing Party IS a financial institution, then the Disclosing Party pledges:

"We are not and will not become a predatory lender as defined in MCC Chapter 2-32. We further pledge that none of our affiliates is, and none of them will become, a predatory lender as defined in MCC Chapter 2-32. We understand that becoming a predatory lender or becoming an affiliate of a predatory lender may result in the loss of the privilege of doing business with the City."

If the Disclosing Party is unable to make this pledge because it or any of its affiliates (as defined in MCC Section 2-32-455(b)) is a predatory lender within the meaning of MCC Chapter 2-32, explain here (attach additional pages if necessary):

N/A

If the letters "NA," the word "None," or no response appears on the lines above, it will be conclusively presumed that the Disclosing Party certified to the above statements.

D. CERTIFICATION REGARDING FINANCIAL INTEREST IN CITY BUSINESS

Any words or terms defined in MCC Chapter 2-156 have the same meanings if used in this Part D.

1. In accordance with MCC Section 2-156-110: To the best of the Disclosing Party's knowledge after reasonable inquiry, does any official or employee of the City have a financial interest in his or her own name or in the name of any other person or entity in the Matter?

Yes

No

NOTE: If you checked "Yes" to Item D(1), proceed to Items D(2) and D(3). If you checked "No" to Item D(1), skip Items D(2) and D(3) and proceed to Part E.

2. Unless sold pursuant to a process of competitive bidding, or otherwise permitted, no City elected official or employee shall have a financial interest in his or her own name or in the name of any other person or entity in the purchase of any property that (i) belongs to the City, or (ii) is sold for taxes or assessments, or (iii) is sold by virtue of legal process at the suit of the City (collectively, "City Property Sale"). Compensation for property taken pursuant to the City's eminent domain power does not constitute a financial interest within the meaning of this Part D.

Does the Matter involve a City Property Sale?

Yes

No

3. If you checked "Yes" to Item D(1), provide the names and business addresses of the City officials or employees having such financial interest and identify the nature of the financial interest:

Name	Business Address	Nature of Financial Interest
------	------------------	------------------------------

4. The Disclosing Party further certifies that no prohibited financial interest in the Matter will be acquired by any City official or employee.

E. CERTIFICATION REGARDING SLAVERY ERA BUSINESS

Please check either (1) or (2) below. If the Disclosing Party checks (2), the Disclosing Party must disclose below or in an attachment to this EDS all information required by (2). Failure to comply with these disclosure requirements may make any contract entered into with the City in connection with the Matter voidable by the City.

 x 1. The Disclosing Party verifies that the Disclosing Party has searched any and all records of the Disclosing Party and any and all predecessor entities regarding records of investments or profits from slavery or slaveholder insurance policies during the slavery era (including insurance policies issued to slaveholders that provided coverage for damage to or injury or death of their slaves), and the Disclosing Party has found no such records.

 2. The Disclosing Party verifies that, as a result of conducting the search in step (1) above, the Disclosing Party has found records of investments or profits from slavery or slaveholder insurance policies. The Disclosing Party verifies that the following constitutes full disclosure of all such records, including the names of any and all slaves or slaveholders described in those records:

SECTION VI -- CERTIFICATIONS FOR FEDERALLY FUNDED MATTERS

NOTE: If the Matter is federally funded, complete this Section VI. If the Matter is not federally funded, proceed to Section VII. For purposes of this Section VI, tax credits allocated by the City and proceeds of debt obligations of the City are not federal funding.

A. CERTIFICATION REGARDING LOBBYING

1. List below the names of all persons or entities registered under the federal Lobbying Disclosure Act of 1995, as amended, who have made lobbying contacts on behalf of the Disclosing Party with respect to the Matter: (Add sheets if necessary):

(If no explanation appears or begins on the lines above, or if the letters "NA" or if the word "None" appear, it will be conclusively presumed that the Disclosing Party means that NO persons or entities registered under the Lobbying Disclosure Act of 1995, as amended, have made lobbying contacts on behalf of the Disclosing Party with respect to the Matter.)

2. The Disclosing Party has not spent and will not expend any federally appropriated funds to pay any person or entity listed in paragraph A(1) above for his or her lobbying activities or to pay any person or entity to influence or attempt to influence an officer or employee of any agency, as defined by applicable federal law, a member of Congress, an officer or employee of Congress, or an employee

of a member of Congress, in connection with the award of any federally funded contract, making any federally funded grant or loan, entering into any cooperative agreement, or to extend, continue, renew, amend, or modify any federally funded contract, grant, loan, or cooperative agreement.

3. The Disclosing Party will submit an updated certification at the end of each calendar quarter in which there occurs any event that materially affects the accuracy of the statements and information set forth in paragraphs A(1) and A(2) above.

4. The Disclosing Party certifies that either: (i) it is not an organization described in section 501(c)(4) of the Internal Revenue Code of 1986; or (ii) it is an organization described in section 501(c)(4) of the Internal Revenue Code of 1986 but has not engaged and will not engage in "Lobbying Activities," as that term is defined in the Lobbying Disclosure Act of 1995, as amended.

5. If the Disclosing Party is the Applicant, the Disclosing Party must obtain certifications equal in form and substance to paragraphs A(1) through A(4) above from all subcontractors before it awards any subcontract and the Disclosing Party must maintain all such subcontractors' certifications for the duration of the Matter and must make such certifications promptly available to the City upon request.

B. CERTIFICATION REGARDING EQUAL EMPLOYMENT OPPORTUNITY

If the Matter is federally funded, federal regulations require the Applicant and all proposed subcontractors to submit the following information with their bids or in writing at the outset of negotiations.

Is the Disclosing Party the Applicant?

Yes No

If "Yes," answer the three questions below:

1. Have you developed and do you have on file affirmative action programs pursuant to applicable federal regulations? (See 41 CFR Part 60-2.)

Yes No

2. Have you filed with the Joint Reporting Committee, the Director of the Office of Federal Contract Compliance Programs, or the Equal Employment Opportunity Commission all reports due under the applicable filing requirements?

Yes No Reports not required

3. Have you participated in any previous contracts or subcontracts subject to the equal opportunity clause?

Yes No

If you checked "No" to question (1) or (2) above, please provide an explanation:

SECTION VII -- FURTHER ACKNOWLEDGMENTS AND CERTIFICATION

The Disclosing Party understands and agrees that:

A. The certifications, disclosures, and acknowledgments contained in this EDS will become part of any contract or other agreement between the Applicant and the City in connection with the Matter, whether procurement, City assistance, or other City action, and are material inducements to the City's execution of any contract or taking other action with respect to the Matter. The Disclosing Party understands that it must comply with all statutes, ordinances, and regulations on which this EDS is based.

B. The City's Governmental Ethics Ordinance, MCC Chapter 2-156, imposes certain duties and obligations on persons or entities seeking City contracts, work, business, or transactions. The full text of this ordinance and a training program is available on line at www.cityofchicago.org/Ethics, and may also be obtained from the City's Board of Ethics, 740 N. Sedgwick St., Suite 500, Chicago, IL 60610, (312) 744-9660. The Disclosing Party must comply fully with this ordinance.

C. If the City determines that any information provided in this EDS is false, incomplete or inaccurate, any contract or other agreement in connection with which it is submitted may be rescinded or be void or voidable, and the City may pursue any remedies under the contract or agreement (if not rescinded or void), at law, or in equity, including terminating the Disclosing Party's participation in the Matter and/or declining to allow the Disclosing Party to participate in other City transactions. Remedies at law for a false statement of material fact may include incarceration and an award to the City of treble damages.

D. It is the City's policy to make this document available to the public on its Internet site and/or upon request. Some or all of the information provided in, and appended to, this EDS may be made publicly available on the Internet, in response to a Freedom of Information Act request, or otherwise. By completing and signing this EDS, the Disclosing Party waives and releases any possible rights or claims which it may have against the City in connection with the public release of information contained in this EDS and also authorizes the City to verify the accuracy of any information submitted in this EDS.

E. The information provided in this EDS must be kept current. In the event of changes, the Disclosing Party must supplement this EDS up to the time the City takes action on the Matter. If the Matter is a contract being handled by the City's Department of Procurement Services, the Disclosing Party must update this EDS as the contract requires. **NOTE:** With respect to Matters subject to MCC Chapter 1-23, Article I (imposing **PERMANENT INELIGIBILITY** for certain specified offenses), the information provided herein regarding eligibility must be kept current for a longer period, as required by MCC Chapter 1-23 and Section 2-154-020.

CERTIFICATION

Under penalty of perjury, the person signing below: (1) warrants that he/she is authorized to execute this EDS, and all applicable Appendices, on behalf of the Disclosing Party, and (2) warrants that all certifications and statements contained in this EDS, and all applicable Appendices, are true, accurate and complete as of the date furnished to the City.

STERLING BAY CAPITAL PARTNERS I, LLC

(Print or type exact legal name of Disclosing Party)

By: _____

(Sign here)

ANDREW GLOOR

(Print or type name of person signing)

Sole Manager of Sterling Bay Capital Management, LLC, manager of Sterling Bay Capital Partners I, LLC
(Print or type title of person signing)

Signed and sworn to before me on (date) 2/26/19,

at Cook County, Illinois (state).

Notary Public



Commission expires: 2/2/22

MISSION STATEMENT
The purpose of the organization is to provide a safe and secure environment for all members of the community. We are committed to the highest standards of service and to the well-being of our members.

**CITY OF CHICAGO
ECONOMIC DISCLOSURE STATEMENT AND AFFIDAVIT
APPENDIX A**

**FAMILIAL RELATIONSHIPS WITH ELECTED CITY OFFICIALS
AND DEPARTMENT HEADS**

This Appendix is to be completed only by (a) the Applicant, and (b) any legal entity which has a direct ownership interest in the Applicant exceeding 7.5%. It is not to be completed by any legal entity which has only an indirect ownership interest in the Applicant.

Under MCC Section 2-154-015, the Disclosing Party must disclose whether such Disclosing Party or any "Applicable Party" or any Spouse or Domestic Partner thereof currently has a "familial relationship" with any elected city official or department head. A "familial relationship" exists if, as of the date this EDS is signed, the Disclosing Party or any "Applicable Party" or any Spouse or Domestic Partner thereof is related to the mayor, any alderman, the city clerk, the city treasurer or any city department head as spouse or domestic partner or as any of the following, whether by blood or adoption: parent, child, brother or sister, aunt or uncle, niece or nephew, grandparent, grandchild, father-in-law, mother-in-law, son-in-law, daughter-in-law, stepfather or stepmother, stepson or stepdaughter, stepbrother or stepsister or half-brother or half-sister.

"Applicable Party" means (1) all executive officers of the Disclosing Party listed in Section II.B.1.a., if the Disclosing Party is a corporation; all partners of the Disclosing Party, if the Disclosing Party is a general partnership; all general partners and limited partners of the Disclosing Party, if the Disclosing Party is a limited partnership; all managers, managing members and members of the Disclosing Party, if the Disclosing Party is a limited liability company; (2) all principal officers of the Disclosing Party; and (3) any person having more than a 7.5% ownership interest in the Disclosing Party. "Principal officers" means the president, chief operating officer, executive director, chief financial officer, treasurer or secretary of a legal entity or any person exercising similar authority.

Does the Disclosing Party or any "Applicable Party" or any Spouse or Domestic Partner thereof currently have a "familial relationship" with an elected city official or department head?

Yes

No

If yes, please identify below (1) the name and title of such person, (2) the name of the legal entity to which such person is connected; (3) the name and title of the elected city official or department head to whom such person has a familial relationship, and (4) the precise nature of such familial relationship.

**CITY OF CHICAGO
ECONOMIC DISCLOSURE STATEMENT AND AFFIDAVIT
APPENDIX B**

BUILDING CODE SCOFFLAW/PROBLEM LANDLORD CERTIFICATION

This Appendix is to be completed only by (a) the Applicant, and (b) any legal entity which has a direct ownership interest in the Applicant exceeding 7.5% (an "Owner"). It is not to be completed by any legal entity which has only an indirect ownership interest in the Applicant.

1. Pursuant to MCC Section 2-154-010, is the Applicant or any Owner identified as a building code scofflaw or problem landlord pursuant to MCC Section 2-92-416?

Yes No

2. If the Applicant is a legal entity publicly traded on any exchange, is any officer or director of the Applicant identified as a building code scofflaw or problem landlord pursuant to MCC Section 2-92-416?

Yes No The Applicant is not publicly traded on any exchange.

3. If yes to (1) or (2) above, please identify below the name of each person or legal entity identified as a building code scofflaw or problem landlord and the address of each building or buildings to which the pertinent code violations apply.

**CITY OF CHICAGO
ECONOMIC DISCLOSURE STATEMENT AND AFFIDAVIT
APPENDIX C**

PROHIBITION ON WAGE & SALARY HISTORY SCREENING - CERTIFICATION

This Appendix is to be completed only by an Applicant that is completing this EDS as a “contractor” as defined in MCC Section 2-92-385. That section, which should be consulted (www.amlegal.com), generally covers a party to any agreement pursuant to which they: (i) receive City of Chicago funds in consideration for services, work or goods provided (including for legal or other professional services), or (ii) pay the City money for a license, grant or concession allowing them to conduct a business on City premises.

On behalf of an Applicant that is a contractor pursuant to MCC Section 2-92-385, I hereby certify that the Applicant is in compliance with MCC Section 2-92-385(b)(1) and (2), which prohibit: (i) screening job applicants based on their wage or salary history, or (ii) seeking job applicants’ wage or salary history from current or former employers. I also certify that the Applicant has adopted a policy that includes those prohibitions.

Yes

No

N/A – I am not an Applicant that is a “contractor” as defined in MCC Section 2-92-385.

This certification shall serve as the affidavit required by MCC Section 2-92-385(c)(1).

If you checked “no” to the above, please explain.

**CITY OF CHICAGO
ECONOMIC DISCLOSURE STATEMENT
AND AFFIDAVIT**

SECTION I -- GENERAL INFORMATION

A. Legal name of the Disclosing Party submitting this EDS. Include d/b/a/ if applicable:

STERLING BAY CAPITAL MANAGEMENT, LLC

Check ONE of the following three boxes:

Indicate whether the Disclosing Party submitting this EDS is:

1. the Applicant

OR

2. a legal entity currently holding, or anticipated to hold within six months after City action on the contract, transaction or other undertaking to which this EDS pertains (referred to below as the "Matter"), a direct or indirect interest in excess of 7.5% in the Applicant. State the Applicant's legal name: _____

OR

3. a legal entity with a direct or indirect right of control of the Applicant (see Section II(B)(1)) State the legal name of the entity in which the Disclosing Party holds a right of control:

345 N. MORGAN, LLC

B. Business address of the Disclosing Party: 1330 W. FULTON ST., SUITE 800
CHICAGO, IL 60607

C. Telephone: 312-466-4142 Fax: 312-874-7008 Email: asimpson@sterlingbay.com

D. Name of contact person: Anna Simpson

E. Federal Employer Identification No. (if you have one): _____

F. Brief description of the Matter to which this EDS pertains. (Include project number and location of property, if applicable):

Application for Planned Development for property commonly known as 345 N. Morgan St., 311 N. Morgan St., and 1000 W. Carroll Ave., Chicago, IL

G. Which City agency or department is requesting this EDS? DPD

If the Matter is a contract being handled by the City's Department of Procurement Services, please complete the following:

Specification # N/A and Contract # N/A

SECTION II -- DISCLOSURE OF OWNERSHIP INTERESTS

A. NATURE OF THE DISCLOSING PARTY

1. Indicate the nature of the Disclosing Party:

- Person
 - Publicly registered business corporation
 - Privately held business corporation
 - Sole proprietorship
 - General partnership
 - Limited partnership
 - Trust
 - Limited liability company
 - Limited liability partnership
 - Joint venture
 - Not-for-profit corporation
- (Is the not-for-profit corporation also a 501(c)(3))?
- Yes No
- Other (please specify)
-

2. For legal entities, the state (or foreign country) of incorporation or organization, if applicable:

Delaware

3. For legal entities not organized in the State of Illinois: Has the organization registered to do business in the State of Illinois as a foreign entity?

- Yes No Organized in Illinois

B. IF THE DISCLOSING PARTY IS A LEGAL ENTITY:

1. List below the full names and titles, if applicable, of: (i) all executive officers and all directors of the entity; (ii) **for not-for-profit corporations**, all members, if any, which are legal entities (if there are no such members, write "no members which are legal entities"); (iii) **for trusts, estates or other similar entities**, the trustee, executor, administrator, or similarly situated party; (iv) **for general or limited partnerships, limited liability companies, limited liability partnerships or joint ventures**, each general partner, managing member, manager or any other person or legal entity that directly or indirectly controls the day-to-day management of the Applicant.

NOTE: Each legal entity listed below must submit an EDS on its own behalf.

Name	Title
Please refer to Applicant EDS	
<hr/>	
<hr/>	

2. Please provide the following information concerning each person or legal entity having a direct or indirect, current or prospective (i.e. within 6 months after City action) beneficial interest (including ownership) in excess of 7.5% of the Applicant. Examples of such an interest include shares in a corporation, partnership interest in a partnership or joint venture, interest of a member or manager in a

Name (indicate whether retained or anticipated to be retained)	Business Address	Relationship to Disclosing Party (subcontractor, attorney, lobbyist, etc.)	Fees (<u>indicate whether paid or estimated.</u>) NOTE: "hourly rate" or "t.b.d." is not an acceptable response.
--	------------------	--	---

(Add sheets if necessary)

Check here if the Disclosing Party has not retained, nor expects to retain, any such persons or entities.

SECTION V -- CERTIFICATIONS

A. COURT-ORDERED CHILD SUPPORT COMPLIANCE

Under MCC Section 2-92-415, substantial owners of business entities that contract with the City must remain in compliance with their child support obligations throughout the contract's term.

Has any person who directly or indirectly owns 10% or more of the Disclosing Party been declared in arrearage on any child support obligations by any Illinois court of competent jurisdiction?

Yes No No person directly or indirectly owns 10% or more of the Disclosing Party.

If "Yes," has the person entered into a court-approved agreement for payment of all support owed and is the person in compliance with that agreement?

Yes No

B. FURTHER CERTIFICATIONS

1. [This paragraph 1 applies only if the Matter is a contract being handled by the City's Department of Procurement Services.] In the 5-year period preceding the date of this EDS, neither the Disclosing Party nor any Affiliated Entity [see definition in (5) below] has engaged, in connection with the performance of any public contract, the services of an integrity monitor, independent private sector inspector general, or integrity compliance consultant (i.e., an individual or entity with legal, auditing, investigative, or other similar skills, designated by a public agency to help the agency monitor the activity of specified agency vendors as well as help the vendors reform their business practices so they can be considered for agency contracts in the future, or continue with a contract in progress).

2. The Disclosing Party and its Affiliated Entities are not delinquent in the payment of any fine, fee, tax or other source of indebtedness owed to the City of Chicago, including, but not limited to, water and sewer charges, license fees, parking tickets, property taxes and sales taxes, nor is the Disclosing Party delinquent in the payment of any tax administered by the Illinois Department of Revenue.

3. The Disclosing Party and, if the Disclosing Party is a legal entity, all of those persons or entities identified in Section II(B)(1) of this EDS:

- a. are not presently debarred, suspended, proposed for debarment, declared ineligible or voluntarily excluded from any transactions by any federal, state or local unit of government;
- b. have not, during the 5 years before the date of this EDS, been convicted of a criminal offense, adjudged guilty, or had a civil judgment rendered against them in connection with: obtaining, attempting to obtain, or performing a public (federal, state or local) transaction or contract under a public transaction; a violation of federal or state antitrust statutes; fraud; embezzlement; theft; forgery; bribery; falsification or destruction of records; making false statements; or receiving stolen property;
- c. are not presently indicted for, or criminally or civilly charged by, a governmental entity (federal, state or local) with committing any of the offenses set forth in subparagraph (b) above;
- d. have not, during the 5 years before the date of this EDS, had one or more public transactions (federal, state or local) terminated for cause or default; and
- e. have not, during the 5 years before the date of this EDS, been convicted, adjudged guilty, or found liable in a civil proceeding, or in any criminal or civil action, including actions concerning environmental violations, instituted by the City or by the federal government, any state, or any other unit of local government.

4. The Disclosing Party understands and shall comply with the applicable requirements of MCC Chapters 2-56 (Inspector General) and 2-156 (Governmental Ethics).

5. Certifications (5), (6) and (7) concern:

- the Disclosing Party;
- any "Contractor" (meaning any contractor or subcontractor used by the Disclosing Party in connection with the Matter, including but not limited to all persons or legal entities disclosed under Section IV, "Disclosure of Subcontractors and Other Retained Parties");
- any "Affiliated Entity" (meaning a person or entity that, directly or indirectly: controls the Disclosing Party, is controlled by the Disclosing Party, or is, with the Disclosing Party, under common control of another person or entity). Indicia of control include, without limitation: interlocking management or ownership; identity of interests among family members, shared facilities and equipment; common use of employees; or organization of a business entity following the ineligibility of a business entity to do business with federal or state or local government, including the City, using substantially the same management, ownership, or principals as the ineligible entity. With respect to Contractors, the term Affiliated Entity means a person or entity that directly or indirectly controls the Contractor, is controlled by it, or, with the Contractor, is under common control of another person or entity;
- any responsible official of the Disclosing Party, any Contractor or any Affiliated Entity or any other official, agent or employee of the Disclosing Party, any Contractor or any Affiliated Entity, acting pursuant to the direction or authorization of a responsible official of the Disclosing Party, any Contractor or any Affiliated Entity (collectively "Agents").

Neither the Disclosing Party, nor any Contractor, nor any Affiliated Entity of either the Disclosing Party or any Contractor, nor any Agents have, during the 5 years before the date of this EDS, or, with respect to a Contractor, an Affiliated Entity, or an Affiliated Entity of a Contractor during the 5 years before the date of such Contractor's or Affiliated Entity's contract or engagement in connection with the Matter:

- a. bribed or attempted to bribe, or been convicted or adjudged guilty of bribery or attempting to bribe, a public officer or employee of the City, the State of Illinois, or any agency of the federal government or of any state or local government in the United States of America, in that officer's or employee's official capacity;
 - b. agreed or colluded with other bidders or prospective bidders, or been a party to any such agreement, or been convicted or adjudged guilty of agreement or collusion among bidders or prospective bidders, in restraint of freedom of competition by agreement to bid a fixed price or otherwise; or
 - c. made an admission of such conduct described in subparagraph (a) or (b) above that is a matter of record, but have not been prosecuted for such conduct; or
 - d. violated the provisions referenced in MCC Subsection 2-92-320(a)(4)(Contracts Requiring a Base Wage); (a)(5)(Debarment Regulations); or (a)(6)(Minimum Wage Ordinance).
6. Neither the Disclosing Party, nor any Affiliated Entity or Contractor, or any of their employees, officials, agents or partners, is barred from contracting with any unit of state or local government as a result of engaging in or being convicted of (1) bid-rigging in violation of 720 ILCS 5/33E-3; (2) bid-rotating in violation of 720 ILCS 5/33E-4; or (3) any similar offense of any state or of the United States of America that contains the same elements as the offense of bid-rigging or bid-rotating.
7. Neither the Disclosing Party nor any Affiliated Entity is listed on a Sanctions List maintained by the United States Department of Commerce, State, or Treasury, or any successor federal agency.
8. [FOR APPLICANT ONLY] (i) Neither the Applicant nor any "controlling person" [see MCC Chapter 1-23, Article I for applicability and defined terms] of the Applicant is currently indicted or charged with, or has admitted guilt of, or has ever been convicted of, or placed under supervision for, any criminal offense involving actual, attempted, or conspiracy to commit bribery, theft, fraud, forgery, perjury, dishonesty or deceit against an officer or employee of the City or any "sister agency"; and (ii) the Applicant understands and acknowledges that compliance with Article I is a continuing requirement for doing business with the City. NOTE: If MCC Chapter 1-23, Article I applies to the Applicant, that Article's permanent compliance timeframe supersedes 5-year compliance timeframes in this Section V.
9. [FOR APPLICANT ONLY] The Applicant and its Affiliated Entities will not use, nor permit their subcontractors to use, any facility listed as having an active exclusion by the U.S. EPA on the federal System for Award Management ("SAM").
10. [FOR APPLICANT ONLY] The Applicant will obtain from any contractors/subcontractors hired or to be hired in connection with the Matter certifications equal in form and substance to those in Certifications (2) and (9) above and will not, without the prior written consent of the City, use any such

contractor/subcontractor that does not provide such certifications or that the Applicant has reason to believe has not provided or cannot provide truthful certifications.

11. If the Disclosing Party is unable to certify to any of the above statements in this Part B (Further Certifications), the Disclosing Party must explain below:

N/A

If the letters "NA," the word "None," or no response appears on the lines above, it will be conclusively presumed that the Disclosing Party certified to the above statements.

12. To the best of the Disclosing Party's knowledge after reasonable inquiry, the following is a complete list of all current employees of the Disclosing Party who were, at any time during the 12-month period preceding the date of this EDS, an employee, or elected or appointed official, of the City of Chicago (if none, indicate with "N/A" or "none").

N/A

13. To the best of the Disclosing Party's knowledge after reasonable inquiry, the following is a complete list of all gifts that the Disclosing Party has given or caused to be given, at any time during the 12-month period preceding the execution date of this EDS, to an employee, or elected or appointed official, of the City of Chicago. For purposes of this statement, a "gift" does not include: (i) anything made generally available to City employees or to the general public, or (ii) food or drink provided in the course of official City business and having a retail value of less than \$25 per recipient, or (iii) a political contribution otherwise duly reported as required by law (if none, indicate with "N/A" or "none"). As to any gift listed below, please also list the name of the City recipient.

N/A

C. CERTIFICATION OF STATUS AS FINANCIAL INSTITUTION

1. The Disclosing Party certifies that the Disclosing Party (check one)

is is not

a "financial institution" as defined in MCC Section 2-32-455(b).

2. If the Disclosing Party IS a financial institution, then the Disclosing Party pledges:

"We are not and will not become a predatory lender as defined in MCC Chapter 2-32. We further pledge that none of our affiliates is, and none of them will become, a predatory lender as defined in MCC Chapter 2-32. We understand that becoming a predatory lender or becoming an affiliate of a predatory lender may result in the loss of the privilege of doing business with the City."

If the Disclosing Party is unable to make this pledge because it or any of its affiliates (as defined in MCC Section 2-32-455(b)) is a predatory lender within the meaning of MCC Chapter 2-32, explain here (attach additional pages if necessary):
N/A

If the letters "NA," the word "None," or no response appears on the lines above, it will be conclusively presumed that the Disclosing Party certified to the above statements.

D. CERTIFICATION REGARDING FINANCIAL INTEREST IN CITY BUSINESS

Any words or terms defined in MCC Chapter 2-156 have the same meanings if used in this Part D.

1. In accordance with MCC Section 2-156-110: To the best of the Disclosing Party's knowledge after reasonable inquiry, does any official or employee of the City have a financial interest in his or her own name or in the name of any other person or entity in the Matter?

Yes No

NOTE: If you checked "Yes" to Item D(1), proceed to Items D(2) and D(3). If you checked "No" to Item D(1), skip Items D(2) and D(3) and proceed to Part E.

2. Unless sold pursuant to a process of competitive bidding, or otherwise permitted, no City elected official or employee shall have a financial interest in his or her own name or in the name of any other person or entity in the purchase of any property that (i) belongs to the City, or (ii) is sold for taxes or assessments, or (iii) is sold by virtue of legal process at the suit of the City (collectively, "City Property Sale"). Compensation for property taken pursuant to the City's eminent domain power does not constitute a financial interest within the meaning of this Part D.

Does the Matter involve a City Property Sale?

Yes No

3. If you checked "Yes" to Item D(1), provide the names and business addresses of the City officials or employees having such financial interest and identify the nature of the financial interest:

Name	Business Address	Nature of Financial Interest
_____	_____	_____
_____	_____	_____
_____	_____	_____

4. The Disclosing Party further certifies that no prohibited financial interest in the Matter will be acquired by any City official or employee.

E. CERTIFICATION REGARDING SLAVERY ERA BUSINESS

Please check either (1) or (2) below. If the Disclosing Party checks (2), the Disclosing Party must disclose below or in an attachment to this EDS all information required by (2). Failure to comply with these disclosure requirements may make any contract entered into with the City in connection with the Matter voidable by the City.

 x 1. The Disclosing Party verifies that the Disclosing Party has searched any and all records of the Disclosing Party and any and all predecessor entities regarding records of investments or profits from slavery or slaveholder insurance policies during the slavery era (including insurance policies issued to slaveholders that provided coverage for damage to or injury or death of their slaves), and the Disclosing Party has found no such records.

 2. The Disclosing Party verifies that, as a result of conducting the search in step (1) above, the Disclosing Party has found records of investments or profits from slavery or slaveholder insurance policies. The Disclosing Party verifies that the following constitutes full disclosure of all such records, including the names of any and all slaves or slaveholders described in those records:

SECTION VI -- CERTIFICATIONS FOR FEDERALLY FUNDED MATTERS

NOTE: If the Matter is federally funded, complete this Section VI. If the Matter is not federally funded, proceed to Section VII. For purposes of this Section VI, tax credits allocated by the City and proceeds of debt obligations of the City are not federal funding.

A. CERTIFICATION REGARDING LOBBYING

1. List below the names of all persons or entities registered under the federal Lobbying Disclosure Act of 1995, as amended, who have made lobbying contacts on behalf of the Disclosing Party with respect to the Matter: (Add sheets if necessary):

(If no explanation appears or begins on the lines above, or if the letters "NA" or if the word "None" appear, it will be conclusively presumed that the Disclosing Party means that NO persons or entities registered under the Lobbying Disclosure Act of 1995, as amended, have made lobbying contacts on behalf of the Disclosing Party with respect to the Matter.)

2. The Disclosing Party has not spent and will not expend any federally appropriated funds to pay any person or entity listed in paragraph A(1) above for his or her lobbying activities or to pay any person or entity to influence or attempt to influence an officer or employee of any agency, as defined by applicable federal law, a member of Congress, an officer or employee of Congress, or an employee

of a member of Congress, in connection with the award of any federally funded contract, making any federally funded grant or loan, entering into any cooperative agreement, or to extend, continue, renew, amend, or modify any federally funded contract, grant, loan, or cooperative agreement.

3. The Disclosing Party will submit an updated certification at the end of each calendar quarter in which there occurs any event that materially affects the accuracy of the statements and information set forth in paragraphs A(1) and A(2) above.

4. The Disclosing Party certifies that either: (i) it is not an organization described in section 501(c)(4) of the Internal Revenue Code of 1986; or (ii) it is an organization described in section 501(c)(4) of the Internal Revenue Code of 1986 but has not engaged and will not engage in "Lobbying Activities," as that term is defined in the Lobbying Disclosure Act of 1995, as amended.

5. If the Disclosing Party is the Applicant, the Disclosing Party must obtain certifications equal in form and substance to paragraphs A(1) through A(4) above from all subcontractors before it awards any subcontract and the Disclosing Party must maintain all such subcontractors' certifications for the duration of the Matter and must make such certifications promptly available to the City upon request.

B. CERTIFICATION REGARDING EQUAL EMPLOYMENT OPPORTUNITY

If the Matter is federally funded, federal regulations require the Applicant and all proposed subcontractors to submit the following information with their bids or in writing at the outset of negotiations.

Is the Disclosing Party the Applicant?

Yes

No

If "Yes," answer the three questions below:

1. Have you developed and do you have on file affirmative action programs pursuant to applicable federal regulations? (See 41 CFR Part 60-2.)

Yes

No

2. Have you filed with the Joint Reporting Committee, the Director of the Office of Federal Contract Compliance Programs, or the Equal Employment Opportunity Commission all reports due under the applicable filing requirements?

Yes

No

Reports not required

3. Have you participated in any previous contracts or subcontracts subject to the equal opportunity clause?

Yes

No

If you checked "No" to question (1) or (2) above, please provide an explanation:

SECTION VII -- FURTHER ACKNOWLEDGMENTS AND CERTIFICATION

The Disclosing Party understands and agrees that:

A. The certifications, disclosures, and acknowledgments contained in this EDS will become part of any contract or other agreement between the Applicant and the City in connection with the Matter, whether procurement, City assistance, or other City action, and are material inducements to the City's execution of any contract or taking other action with respect to the Matter. The Disclosing Party understands that it must comply with all statutes, ordinances, and regulations on which this EDS is based.

B. The City's Governmental Ethics Ordinance, MCC Chapter 2-156, imposes certain duties and obligations on persons or entities seeking City contracts, work, business, or transactions. The full text of this ordinance and a training program is available on line at www.cityofchicago.org/Ethics, and may also be obtained from the City's Board of Ethics, 740 N. Sedgwick St., Suite 500, Chicago, IL 60610, (312) 744-9660. The Disclosing Party must comply fully with this ordinance.

C. If the City determines that any information provided in this EDS is false, incomplete or inaccurate, any contract or other agreement in connection with which it is submitted may be rescinded or be void or voidable, and the City may pursue any remedies under the contract or agreement (if not rescinded or void), at law, or in equity, including terminating the Disclosing Party's participation in the Matter and/or declining to allow the Disclosing Party to participate in other City transactions. Remedies at law for a false statement of material fact may include incarceration and an award to the City of treble damages.

D. It is the City's policy to make this document available to the public on its Internet site and/or upon request. Some or all of the information provided in, and appended to, this EDS may be made publicly available on the Internet, in response to a Freedom of Information Act request, or otherwise. By completing and signing this EDS, the Disclosing Party waives and releases any possible rights or claims which it may have against the City in connection with the public release of information contained in this EDS and also authorizes the City to verify the accuracy of any information submitted in this EDS.

E. The information provided in this EDS must be kept current. In the event of changes, the Disclosing Party must supplement this EDS up to the time the City takes action on the Matter. If the Matter is a contract being handled by the City's Department of Procurement Services, the Disclosing Party must update this EDS as the contract requires. **NOTE:** With respect to Matters subject to MCC Chapter 1-23, Article I (imposing **PERMANENT INELIGIBILITY** for certain specified offenses), the information provided herein regarding eligibility must be kept current for a longer period, as required by MCC Chapter 1-23 and Section 2-154-020.

CERTIFICATION

Under penalty of perjury, the person signing below: (1) warrants that he/she is authorized to execute this EDS, and all applicable Appendices, on behalf of the Disclosing Party, and (2) warrants that all certifications and statements contained in this EDS, and all applicable Appendices, are true, accurate and complete as of the date furnished to the City.

STERLING BAY CAPITAL MANAGEMENT, LLC

(Print or type exact legal name of Disclosing Party)

By: _____

(Sign here)

ANDREW GLOOR

(Print or type name of person signing)

Sole Manager of Sterling Bay Capital Management, LLC

(Print or type title of person signing)

Signed and sworn to before me on (date) 2/26/19,

at Cook County, Illinois (state).

Notary Public

Commission expires: 2/2/22



THE UNIVERSITY OF CHICAGO
LIBRARY
1100 EAST 58TH STREET
CHICAGO, ILL. 60637
TEL: 773-936-3200

**CITY OF CHICAGO
ECONOMIC DISCLOSURE STATEMENT AND AFFIDAVIT
APPENDIX A**

**FAMILIAL RELATIONSHIPS WITH ELECTED CITY OFFICIALS
AND DEPARTMENT HEADS**

This Appendix is to be completed only by (a) the Applicant, and (b) any legal entity which has a direct ownership interest in the Applicant exceeding 7.5%. It is not to be completed by any legal entity which has only an indirect ownership interest in the Applicant.

Under MCC Section 2-154-015, the Disclosing Party must disclose whether such Disclosing Party or any "Applicable Party" or any Spouse or Domestic Partner thereof currently has a "familial relationship" with any elected city official or department head. A "familial relationship" exists if, as of the date this EDS is signed, the Disclosing Party or any "Applicable Party" or any Spouse or Domestic Partner thereof is related to the mayor, any alderman, the city clerk, the city treasurer or any city department head as spouse or domestic partner or as any of the following, whether by blood or adoption: parent, child, brother or sister, aunt or uncle, niece or nephew, grandparent, grandchild, father-in-law, mother-in-law, son-in-law, daughter-in-law, stepfather or stepmother, stepson or stepdaughter, stepbrother or stepsister or half-brother or half-sister.

"Applicable Party" means (1) all executive officers of the Disclosing Party listed in Section II.B.1.a., if the Disclosing Party is a corporation; all partners of the Disclosing Party, if the Disclosing Party is a general partnership; all general partners and limited partners of the Disclosing Party, if the Disclosing Party is a limited partnership; all managers, managing members and members of the Disclosing Party, if the Disclosing Party is a limited liability company; (2) all principal officers of the Disclosing Party; and (3) any person having more than a 7.5% ownership interest in the Disclosing Party. "Principal officers" means the president, chief operating officer, executive director, chief financial officer, treasurer or secretary of a legal entity or any person exercising similar authority.

Does the Disclosing Party or any "Applicable Party" or any Spouse or Domestic Partner thereof currently have a "familial relationship" with an elected city official or department head?

[] Yes

[x] No

If yes, please identify below (1) the name and title of such person, (2) the name of the legal entity to which such person is connected; (3) the name and title of the elected city official or department head to whom such person has a familial relationship, and (4) the precise nature of such familial relationship.

**CITY OF CHICAGO
ECONOMIC DISCLOSURE STATEMENT AND AFFIDAVIT
APPENDIX B**

BUILDING CODE SCOFFLAW/PROBLEM LANDLORD CERTIFICATION

This Appendix is to be completed only by (a) the Applicant, and (b) any legal entity which has a direct ownership interest in the Applicant exceeding 7.5% (an "Owner"). It is not to be completed by any legal entity which has only an indirect ownership interest in the Applicant.

1. Pursuant to MCC Section 2-154-010, is the Applicant or any Owner identified as a building code scofflaw or problem landlord pursuant to MCC Section 2-92-416?

Yes No

2. If the Applicant is a legal entity publicly traded on any exchange, is any officer or director of the Applicant identified as a building code scofflaw or problem landlord pursuant to MCC Section 2-92-416?

Yes No The Applicant is not publicly traded on any exchange.

3. If yes to (1) or (2) above, please identify below the name of each person or legal entity identified as a building code scofflaw or problem landlord and the address of each building or buildings to which the pertinent code violations apply.

**CITY OF CHICAGO
ECONOMIC DISCLOSURE STATEMENT AND AFFIDAVIT
APPENDIX C**

PROHIBITION ON WAGE & SALARY HISTORY SCREENING - CERTIFICATION

This Appendix is to be completed only by an Applicant that is completing this EDS as a “contractor” as defined in MCC Section 2-92-385. That section, which should be consulted (www.amlegal.com), generally covers a party to any agreement pursuant to which they: (i) receive City of Chicago funds in consideration for services, work or goods provided (including for legal or other professional services), or (ii) pay the City money for a license, grant or concession allowing them to conduct a business on City premises.

On behalf of an Applicant that is a contractor pursuant to MCC Section 2-92-385, I hereby certify that the Applicant is in compliance with MCC Section 2-92-385(b)(1) and (2), which prohibit: (i) screening job applicants based on their wage or salary history, or (ii) seeking job applicants’ wage or salary history from current or former employers. I also certify that the Applicant has adopted a policy that includes those prohibitions.

Yes

No

N/A – I am not an Applicant that is a “contractor” as defined in MCC Section 2-92-385.

This certification shall serve as the affidavit required by MCC Section 2-92-385(c)(1).

If you checked “no” to the above, please explain.

**CITY OF CHICAGO
ECONOMIC DISCLOSURE STATEMENT
AND AFFIDAVIT**

SECTION I -- GENERAL INFORMATION

A. Legal name of the Disclosing Party submitting this EDS. Include d/b/a/ if applicable:

345 N. MORGAN MANAGER, LLC

Check ONE of the following three boxes:

Indicate whether the Disclosing Party submitting this EDS is:

1. the Applicant

OR

2. a legal entity currently holding, or anticipated to hold within six months after City action on the contract, transaction or other undertaking to which this EDS pertains (referred to below as the "Matter"), a direct or indirect interest in excess of 7.5% in the Applicant. State the Applicant's legal name:

OR

3. a legal entity with a direct or indirect right of control of the Applicant (see Section II(B)(1))

State the legal name of the entity in which the Disclosing Party holds a right of control:

345 N. MORGAN, LLC

B. Business address of the Disclosing Party: 1330 W. FULTON ST., SUITE 800
CHICAGO, IL 60607

C. Telephone: 312-466-4142 Fax: 312-874-7008 Email: asimpson@sterlingbay.com

D. Name of contact person: Anna Simpson

E. Federal Employer Identification No. (if you have one): _____

F. Brief description of the Matter to which this EDS pertains. (Include project number and location of property, if applicable):

Application for Planned Development for property commonly known as 345 N. Morgan St., 311 N. Morgan St., and 1000 W. Carroll Ave., Chicago, IL

G. Which City agency or department is requesting this EDS? DPD

If the Matter is a contract being handled by the City's Department of Procurement Services, please complete the following:

Specification # N/A and Contract # N/A

SECTION II -- DISCLOSURE OF OWNERSHIP INTERESTS

A. NATURE OF THE DISCLOSING PARTY

1. Indicate the nature of the Disclosing Party:

- Person
 - Publicly registered business corporation
 - Privately held business corporation
 - Sole proprietorship
 - General partnership
 - Limited partnership
 - Trust
 - Limited liability company
 - Limited liability partnership
 - Joint venture
 - Not-for-profit corporation
(Is the not-for-profit corporation also a 501(c)(3))?
 Yes No
 - Other (please specify)
-

2. For legal entities, the state (or foreign country) of incorporation or organization, if applicable:

Delaware

3. For legal entities not organized in the State of Illinois: Has the organization registered to do business in the State of Illinois as a foreign entity?

- Yes
- No
- Organized in Illinois

B. IF THE DISCLOSING PARTY IS A LEGAL ENTITY:

1. List below the full names and titles, if applicable, of: (i) all executive officers and all directors of the entity; (ii) **for not-for-profit corporations**, all members, if any, which are legal entities (if there are no such members, write "no members which are legal entities"); (iii) **for trusts, estates or other similar entities**, the trustee, executor, administrator, or similarly situated party; (iv) **for general or limited partnerships, limited liability companies, limited liability partnerships or joint ventures**, each general partner, managing member, manager or any other person or legal entity that directly or indirectly controls the day-to-day management of the Applicant.

NOTE: Each legal entity listed below must submit an EDS on its own behalf.

Name	Title
Please refer to Applicant EDS	

2. Please provide the following information concerning each person or legal entity having a direct or indirect, current or prospective (i.e. within 6 months after City action) beneficial interest (including ownership) in excess of 7.5% of the Applicant. Examples of such an interest include shares in a corporation, partnership interest in a partnership or joint venture, interest of a member or manager in a

limited liability company, or interest of a beneficiary of a trust, estate or other similar entity. If none, state "None."

NOTE: Each legal entity listed below may be required to submit an EDS on its own behalf.

Name	Business Address	Percentage Interest in the Applicant
Please see attached Exhibit A		

SECTION III -- INCOME OR COMPENSATION TO, OR OWNERSHIP BY, CITY ELECTED OFFICIALS

Has the Disclosing Party provided any income or compensation to any City elected official during the 12-month period preceding the date of this EDS? Yes No

Does the Disclosing Party reasonably expect to provide any income or compensation to any City elected official during the 12-month period following the date of this EDS? Yes No

If "yes" to either of the above, please identify below the name(s) of such City elected official(s) and describe such income or compensation:

Does any City elected official or, to the best of the Disclosing Party's knowledge after reasonable inquiry, any City elected official's spouse or domestic partner, have a financial interest (as defined in Chapter 2-156 of the Municipal Code of Chicago ("MCC")) in the Disclosing Party? Yes No

If "yes," please identify below the name(s) of such City elected official(s) and/or spouse(s)/domestic partner(s) and describe the financial interest(s).

SECTION IV -- DISCLOSURE OF SUBCONTRACTORS AND OTHER RETAINED PARTIES

The Disclosing Party must disclose the name and business address of each subcontractor, attorney, lobbyist (as defined in MCC Chapter 2-156), accountant, consultant and any other person or entity whom the Disclosing Party has retained or expects to retain in connection with the Matter, as well as the nature of the relationship, and the total amount of the fees paid or estimated to be paid. The Disclosing Party is not required to disclose employees who are paid solely through the Disclosing Party's regular payroll. If the Disclosing Party is uncertain whether a disclosure is required under this Section, the Disclosing Party must either ask the City whether disclosure is required or make the disclosure.

Name (indicate whether retained or anticipated to be retained)	Business Address	Relationship to Disclosing Party (subcontractor, attorney, lobbyist, etc.)	Fees (<u>indicate whether paid or estimated.</u>) NOTE: "hourly rate" or "t.b.d." is not an acceptable response.
--	------------------	--	---

(Add sheets if necessary)

Check here if the Disclosing Party has not retained, nor expects to retain, any such persons or entities.

SECTION V -- CERTIFICATIONS

A. COURT-ORDERED CHILD SUPPORT COMPLIANCE

Under MCC Section 2-92-415, substantial owners of business entities that contract with the City must remain in compliance with their child support obligations throughout the contract's term.

Has any person who directly or indirectly owns 10% or more of the Disclosing Party been declared in arrearage on any child support obligations by any Illinois court of competent jurisdiction?

Yes No No person directly or indirectly owns 10% or more of the Disclosing Party.

If "Yes," has the person entered into a court-approved agreement for payment of all support owed and is the person in compliance with that agreement?

Yes No

B. FURTHER CERTIFICATIONS

1. [This paragraph 1 applies only if the Matter is a contract being handled by the City's Department of Procurement Services.] In the 5-year period preceding the date of this EDS, neither the Disclosing Party nor any Affiliated Entity [see definition in (5) below] has engaged, in connection with the performance of any public contract, the services of an integrity monitor, independent private sector inspector general, or integrity compliance consultant (i.e., an individual or entity with legal, auditing, investigative, or other similar skills, designated by a public agency to help the agency monitor the activity of specified agency vendors as well as help the vendors reform their business practices so they can be considered for agency contracts in the future, or continue with a contract in progress).

2. The Disclosing Party and its Affiliated Entities are not delinquent in the payment of any fine, fee, tax or other source of indebtedness owed to the City of Chicago, including, but not limited to, water and sewer charges, license fees, parking tickets, property taxes and sales taxes, nor is the Disclosing Party delinquent in the payment of any tax administered by the Illinois Department of Revenue.

3. The Disclosing Party and, if the Disclosing Party is a legal entity, all of those persons or entities identified in Section II(B)(1) of this EDS:

- a. are not presently debarred, suspended, proposed for debarment, declared ineligible or voluntarily excluded from any transactions by any federal, state or local unit of government;
- b. have not, during the 5 years before the date of this EDS, been convicted of a criminal offense, adjudged guilty, or had a civil judgment rendered against them in connection with: obtaining, attempting to obtain, or performing a public (federal, state or local) transaction or contract under a public transaction; a violation of federal or state antitrust statutes; fraud; embezzlement; theft; forgery; bribery; falsification or destruction of records; making false statements; or receiving stolen property;
- c. are not presently indicted for, or criminally or civilly charged by, a governmental entity (federal, state or local) with committing any of the offenses set forth in subparagraph (b) above;
- d. have not, during the 5 years before the date of this EDS, had one or more public transactions (federal, state or local) terminated for cause or default; and
- e. have not, during the 5 years before the date of this EDS, been convicted, adjudged guilty, or found liable in a civil proceeding, or in any criminal or civil action, including actions concerning environmental violations, instituted by the City or by the federal government, any state, or any other unit of local government.

4. The Disclosing Party understands and shall comply with the applicable requirements of MCC Chapters 2-56 (Inspector General) and 2-156 (Governmental Ethics).

5. Certifications (5), (6) and (7) concern:

- the Disclosing Party;
- any "Contractor" (meaning any contractor or subcontractor used by the Disclosing Party in connection with the Matter, including but not limited to all persons or legal entities disclosed under Section IV, "Disclosure of Subcontractors and Other Retained Parties");
- any "Affiliated Entity" (meaning a person or entity that, directly or indirectly: controls the Disclosing Party, is controlled by the Disclosing Party, or is, with the Disclosing Party, under common control of another person or entity). Indicia of control include, without limitation: interlocking management or ownership; identity of interests among family members, shared facilities and equipment; common use of employees; or organization of a business entity following the ineligibility of a business entity to do business with federal or state or local government, including the City, using substantially the same management, ownership, or principals as the ineligible entity. With respect to Contractors, the term Affiliated Entity means a person or entity that directly or indirectly controls the Contractor, is controlled by it, or, with the Contractor, is under common control of another person or entity;
- any responsible official of the Disclosing Party, any Contractor or any Affiliated Entity or any other official, agent or employee of the Disclosing Party, any Contractor or any Affiliated Entity, acting pursuant to the direction or authorization of a responsible official of the Disclosing Party, any Contractor or any Affiliated Entity (collectively "Agents").

Neither the Disclosing Party, nor any Contractor, nor any Affiliated Entity of either the Disclosing Party or any Contractor, nor any Agents have, during the 5 years before the date of this EDS, or, with respect to a Contractor, an Affiliated Entity, or an Affiliated Entity of a Contractor during the 5 years before the date of such Contractor's or Affiliated Entity's contract or engagement in connection with the Matter:

- a. bribed or attempted to bribe, or been convicted or adjudged guilty of bribery or attempting to bribe, a public officer or employee of the City, the State of Illinois, or any agency of the federal government or of any state or local government in the United States of America, in that officer's or employee's official capacity;
 - b. agreed or colluded with other bidders or prospective bidders, or been a party to any such agreement, or been convicted or adjudged guilty of agreement or collusion among bidders or prospective bidders, in restraint of freedom of competition by agreement to bid a fixed price or otherwise; or
 - c. made an admission of such conduct described in subparagraph (a) or (b) above that is a matter of record, but have not been prosecuted for such conduct; or
 - d. violated the provisions referenced in MCC Subsection 2-92-320(a)(4)(Contracts Requiring a Base Wage); (a)(5)(Debarment Regulations); or (a)(6)(Minimum Wage Ordinance).
6. Neither the Disclosing Party, nor any Affiliated Entity or Contractor, or any of their employees, officials, agents or partners, is barred from contracting with any unit of state or local government as a result of engaging in or being convicted of (1) bid-rigging in violation of 720 ILCS 5/33E-3; (2) bid-rotating in violation of 720 ILCS 5/33E-4; or (3) any similar offense of any state or of the United States of America that contains the same elements as the offense of bid-rigging or bid-rotating.
7. Neither the Disclosing Party nor any Affiliated Entity is listed on a Sanctions List maintained by the United States Department of Commerce, State, or Treasury, or any successor federal agency.
8. [FOR APPLICANT ONLY] (i) Neither the Applicant nor any "controlling person" [see MCC Chapter 1-23, Article I for applicability and defined terms] of the Applicant is currently indicted or charged with, or has admitted guilt of, or has ever been convicted of, or placed under supervision for, any criminal offense involving actual, attempted, or conspiracy to commit bribery, theft, fraud, forgery, perjury, dishonesty or deceit against an officer or employee of the City or any "sister agency"; and (ii) the Applicant understands and acknowledges that compliance with Article I is a continuing requirement for doing business with the City. NOTE: If MCC Chapter 1-23, Article I applies to the Applicant, that Article's permanent compliance timeframe supersedes 5-year compliance timeframes in this Section V.
9. [FOR APPLICANT ONLY] The Applicant and its Affiliated Entities will not use, nor permit their subcontractors to use, any facility listed as having an active exclusion by the U.S. EPA on the federal System for Award Management ("SAM").
10. [FOR APPLICANT ONLY] The Applicant will obtain from any contractors/subcontractors hired or to be hired in connection with the Matter certifications equal in form and substance to those in Certifications (2) and (9) above and will not, without the prior written consent of the City, use any such

contractor/subcontractor that does not provide such certifications or that the Applicant has reason to believe has not provided or cannot provide truthful certifications.

11. If the Disclosing Party is unable to certify to any of the above statements in this Part B (Further Certifications), the Disclosing Party must explain below:

N/A

If the letters "NA," the word "None," or no response appears on the lines above, it will be conclusively presumed that the Disclosing Party certified to the above statements.

12. To the best of the Disclosing Party's knowledge after reasonable inquiry, the following is a complete list of all current employees of the Disclosing Party who were, at any time during the 12-month period preceding the date of this EDS, an employee, or elected or appointed official, of the City of Chicago (if none, indicate with "N/A" or "none").

N/A

13. To the best of the Disclosing Party's knowledge after reasonable inquiry, the following is a complete list of all gifts that the Disclosing Party has given or caused to be given, at any time during the 12-month period preceding the execution date of this EDS, to an employee, or elected or appointed official, of the City of Chicago. For purposes of this statement, a "gift" does not include: (i) anything made generally available to City employees or to the general public, or (ii) food or drink provided in the course of official City business and having a retail value of less than \$25 per recipient, or (iii) a political contribution otherwise duly reported as required by law (if none, indicate with "N/A" or "none"). As to any gift listed below, please also list the name of the City recipient.

N/A

C. CERTIFICATION OF STATUS AS FINANCIAL INSTITUTION

1. The Disclosing Party certifies that the Disclosing Party (check one)

is is not

a "financial institution" as defined in MCC Section 2-32-455(b).

2. If the Disclosing Party IS a financial institution, then the Disclosing Party pledges:

"We are not and will not become a predatory lender as defined in MCC Chapter 2-32. We further pledge that none of our affiliates is, and none of them will become, a predatory lender as defined in MCC Chapter 2-32. We understand that becoming a predatory lender or becoming an affiliate of a predatory lender may result in the loss of the privilege of doing business with the City."

If the Disclosing Party is unable to make this pledge because it or any of its affiliates (as defined in MCC Section 2-32-455(b)) is a predatory lender within the meaning of MCC Chapter 2-32, explain here (attach additional pages if necessary):

N/A

If the letters "NA," the word "None," or no response appears on the lines above, it will be conclusively presumed that the Disclosing Party certified to the above statements.

D. CERTIFICATION REGARDING FINANCIAL INTEREST IN CITY BUSINESS

Any words or terms defined in MCC Chapter 2-156 have the same meanings if used in this Part D.

1. In accordance with MCC Section 2-156-110: To the best of the Disclosing Party's knowledge after reasonable inquiry, does any official or employee of the City have a financial interest in his or her own name or in the name of any other person or entity in the Matter?

Yes

No

NOTE: If you checked "Yes" to Item D(1), proceed to Items D(2) and D(3). If you checked "No" to Item D(1), skip Items D(2) and D(3) and proceed to Part E.

2. Unless sold pursuant to a process of competitive bidding, or otherwise permitted, no City elected official or employee shall have a financial interest in his or her own name or in the name of any other person or entity in the purchase of any property that (i) belongs to the City, or (ii) is sold for taxes or assessments, or (iii) is sold by virtue of legal process at the suit of the City (collectively, "City Property Sale"). Compensation for property taken pursuant to the City's eminent domain power does not constitute a financial interest within the meaning of this Part D.

Does the Matter involve a City Property Sale?

Yes

No

3. If you checked "Yes" to Item D(1), provide the names and business addresses of the City officials or employees having such financial interest and identify the nature of the financial interest:

Name	Business Address	Nature of Financial Interest
<hr/>		
<hr/>		
<hr/>		

4. The Disclosing Party further certifies that no prohibited financial interest in the Matter will be acquired by any City official or employee.

E. CERTIFICATION REGARDING SLAVERY ERA BUSINESS

Please check either (1) or (2) below. If the Disclosing Party checks (2), the Disclosing Party must disclose below or in an attachment to this EDS all information required by (2). Failure to comply with these disclosure requirements may make any contract entered into with the City in connection with the Matter voidable by the City.

 x 1. The Disclosing Party verifies that the Disclosing Party has searched any and all records of the Disclosing Party and any and all predecessor entities regarding records of investments or profits from slavery or slaveholder insurance policies during the slavery era (including insurance policies issued to slaveholders that provided coverage for damage to or injury or death of their slaves), and the Disclosing Party has found no such records.

 2. The Disclosing Party verifies that, as a result of conducting the search in step (1) above, the Disclosing Party has found records of investments or profits from slavery or slaveholder insurance policies. The Disclosing Party verifies that the following constitutes full disclosure of all such records, including the names of any and all slaves or slaveholders described in those records:

SECTION VI -- CERTIFICATIONS FOR FEDERALLY FUNDED MATTERS

NOTE: If the Matter is federally funded, complete this Section VI. If the Matter is not federally funded, proceed to Section VII. For purposes of this Section VI, tax credits allocated by the City and proceeds of debt obligations of the City are not federal funding.

A. CERTIFICATION REGARDING LOBBYING

1. List below the names of all persons or entities registered under the federal Lobbying Disclosure Act of 1995, as amended, who have made lobbying contacts on behalf of the Disclosing Party with respect to the Matter: (Add sheets if necessary):

(If no explanation appears or begins on the lines above, or if the letters "NA" or if the word "None" appear, it will be conclusively presumed that the Disclosing Party means that NO persons or entities registered under the Lobbying Disclosure Act of 1995, as amended, have made lobbying contacts on behalf of the Disclosing Party with respect to the Matter.)

2. The Disclosing Party has not spent and will not expend any federally appropriated funds to pay any person or entity listed in paragraph A(1) above for his or her lobbying activities or to pay any person or entity to influence or attempt to influence an officer or employee of any agency, as defined by applicable federal law, a member of Congress, an officer or employee of Congress, or an employee

of a member of Congress, in connection with the award of any federally funded contract, making any federally funded grant or loan, entering into any cooperative agreement, or to extend, continue, renew, amend, or modify any federally funded contract, grant, loan, or cooperative agreement.

3. The Disclosing Party will submit an updated certification at the end of each calendar quarter in which there occurs any event that materially affects the accuracy of the statements and information set forth in paragraphs A(1) and A(2) above.

4. The Disclosing Party certifies that either: (i) it is not an organization described in section 501(c)(4) of the Internal Revenue Code of 1986; or (ii) it is an organization described in section 501(c)(4) of the Internal Revenue Code of 1986 but has not engaged and will not engage in "Lobbying Activities," as that term is defined in the Lobbying Disclosure Act of 1995, as amended.

5. If the Disclosing Party is the Applicant, the Disclosing Party must obtain certifications equal in form and substance to paragraphs A(1) through A(4) above from all subcontractors before it awards any subcontract and the Disclosing Party must maintain all such subcontractors' certifications for the duration of the Matter and must make such certifications promptly available to the City upon request.

B. CERTIFICATION REGARDING EQUAL EMPLOYMENT OPPORTUNITY

If the Matter is federally funded, federal regulations require the Applicant and all proposed subcontractors to submit the following information with their bids or in writing at the outset of negotiations.

Is the Disclosing Party the Applicant?

Yes

No

If "Yes," answer the three questions below:

1. Have you developed and do you have on file affirmative action programs pursuant to applicable federal regulations? (See 41 CFR Part 60-2.)

Yes

No

2. Have you filed with the Joint Reporting Committee, the Director of the Office of Federal Contract Compliance Programs, or the Equal Employment Opportunity Commission all reports due under the applicable filing requirements?

Yes

No

Reports not required

3. Have you participated in any previous contracts or subcontracts subject to the equal opportunity clause?

Yes

No

If you checked "No" to question (1) or (2) above, please provide an explanation:

SECTION VII -- FURTHER ACKNOWLEDGMENTS AND CERTIFICATION

The Disclosing Party understands and agrees that:

A. The certifications, disclosures, and acknowledgments contained in this EDS will become part of any contract or other agreement between the Applicant and the City in connection with the Matter, whether procurement, City assistance, or other City action, and are material inducements to the City's execution of any contract or taking other action with respect to the Matter. The Disclosing Party understands that it must comply with all statutes, ordinances, and regulations on which this EDS is based.

B. The City's Governmental Ethics Ordinance, MCC Chapter 2-156, imposes certain duties and obligations on persons or entities seeking City contracts, work, business, or transactions. The full text of this ordinance and a training program is available on line at www.cityofchicago.org/Ethics, and may also be obtained from the City's Board of Ethics, 740 N. Sedgwick St., Suite 500, Chicago, IL 60610, (312) 744-9660. The Disclosing Party must comply fully with this ordinance.

C. If the City determines that any information provided in this EDS is false, incomplete or inaccurate, any contract or other agreement in connection with which it is submitted may be rescinded or be void or voidable, and the City may pursue any remedies under the contract or agreement (if not rescinded or void), at law, or in equity, including terminating the Disclosing Party's participation in the Matter and/or declining to allow the Disclosing Party to participate in other City transactions. Remedies at law for a false statement of material fact may include incarceration and an award to the City of treble damages.

D. It is the City's policy to make this document available to the public on its Internet site and/or upon request. Some or all of the information provided in, and appended to, this EDS may be made publicly available on the Internet, in response to a Freedom of Information Act request, or otherwise. By completing and signing this EDS, the Disclosing Party waives and releases any possible rights or claims which it may have against the City in connection with the public release of information contained in this EDS and also authorizes the City to verify the accuracy of any information submitted in this EDS.

E. The information provided in this EDS must be kept current. In the event of changes, the Disclosing Party must supplement this EDS up to the time the City takes action on the Matter. If the Matter is a contract being handled by the City's Department of Procurement Services, the Disclosing Party must update this EDS as the contract requires. **NOTE:** With respect to Matters subject to MCC Chapter 1-23, Article I (imposing **PERMANENT INELIGIBILITY** for certain specified offenses), the information provided herein regarding eligibility must be kept current for a longer period, as required by MCC Chapter 1-23 and Section 2-154-020.

CERTIFICATION

Under penalty of perjury, the person signing below: (1) warrants that he/she is authorized to execute this EDS, and all applicable Appendices, on behalf of the Disclosing Party, and (2) warrants that all certifications and statements contained in this EDS, and all applicable Appendices, are true, accurate and complete as of the date furnished to the City.

345 N. MORGAN MANAGER, LLC
(Print or type exact legal name of Disclosing Party)

By: _____
(Sign here)

ANDREW GLOOR
(Print or type name of person signing)

Sole Manager of Sterling Bay Capital Management, LLC, manager of 345 N. Morgan Manager, LLC
(Print or type title of person signing)

Signed and sworn to before me on (date) 2/26/19,

at Cook County, Illinois (state).

Notary Public

Commission expires: 2/2/22



1

OFFICE OF THE
ATTORNEY GENERAL
STATE OF CALIFORNIA
SAN FRANCISCO

**CITY OF CHICAGO
ECONOMIC DISCLOSURE STATEMENT AND AFFIDAVIT
APPENDIX A**

**FAMILIAL RELATIONSHIPS WITH ELECTED CITY OFFICIALS
AND DEPARTMENT HEADS**

This Appendix is to be completed only by (a) the Applicant, and (b) any legal entity which has a direct ownership interest in the Applicant exceeding 7.5%. It is not to be completed by any legal entity which has only an indirect ownership interest in the Applicant.

Under MCC Section 2-154-015, the Disclosing Party must disclose whether such Disclosing Party or any "Applicable Party" or any Spouse or Domestic Partner thereof currently has a "familial relationship" with any elected city official or department head. A "familial relationship" exists if, as of the date this EDS is signed, the Disclosing Party or any "Applicable Party" or any Spouse or Domestic Partner thereof is related to the mayor, any alderman, the city clerk, the city treasurer or any city department head as spouse or domestic partner or as any of the following, whether by blood or adoption: parent, child, brother or sister, aunt or uncle, niece or nephew, grandparent, grandchild, father-in-law, mother-in-law, son-in-law, daughter-in-law, stepfather or stepmother, stepson or stepdaughter, stepbrother or stepsister or half-brother or half-sister.

"Applicable Party" means (1) all executive officers of the Disclosing Party listed in Section II.B.1.a., if the Disclosing Party is a corporation; all partners of the Disclosing Party, if the Disclosing Party is a general partnership; all general partners and limited partners of the Disclosing Party, if the Disclosing Party is a limited partnership; all managers, managing members and members of the Disclosing Party, if the Disclosing Party is a limited liability company; (2) all principal officers of the Disclosing Party; and (3) any person having more than a 7.5% ownership interest in the Disclosing Party. "Principal officers" means the president, chief operating officer, executive director, chief financial officer, treasurer or secretary of a legal entity or any person exercising similar authority.

Does the Disclosing Party or any "Applicable Party" or any Spouse or Domestic Partner thereof currently have a "familial relationship" with an elected city official or department head?

Yes

No

If yes, please identify below (1) the name and title of such person, (2) the name of the legal entity to which such person is connected; (3) the name and title of the elected city official or department head to whom such person has a familial relationship, and (4) the precise nature of such familial relationship.

**CITY OF CHICAGO
ECONOMIC DISCLOSURE STATEMENT AND AFFIDAVIT
APPENDIX B**

BUILDING CODE SCOFFLAW/PROBLEM LANDLORD CERTIFICATION

This Appendix is to be completed only by (a) the Applicant, and (b) any legal entity which has a direct ownership interest in the Applicant exceeding 7.5% (an "Owner"). It is not to be completed by any legal entity which has only an indirect ownership interest in the Applicant.

1. Pursuant to MCC Section 2-154-010, is the Applicant or any Owner identified as a building code scofflaw or problem landlord pursuant to MCC Section 2-92-416?

Yes No

2. If the Applicant is a legal entity publicly traded on any exchange, is any officer or director of the Applicant identified as a building code scofflaw or problem landlord pursuant to MCC Section 2-92-416?

Yes No The Applicant is not publicly traded on any exchange.

3. If yes to (1) or (2) above, please identify below the name of each person or legal entity identified as a building code scofflaw or problem landlord and the address of each building or buildings to which the pertinent code violations apply.

**CITY OF CHICAGO
ECONOMIC DISCLOSURE STATEMENT AND AFFIDAVIT
APPENDIX C**

PROHIBITION ON WAGE & SALARY HISTORY SCREENING - CERTIFICATION

This Appendix is to be completed only by an Applicant that is completing this EDS as a “contractor” as defined in MCC Section 2-92-385. That section, which should be consulted (www.amlegal.com), generally covers a party to any agreement pursuant to which they: (i) receive City of Chicago funds in consideration for services, work or goods provided (including for legal or other professional services), or (ii) pay the City money for a license, grant or concession allowing them to conduct a business on City premises.

On behalf of an Applicant that is a contractor pursuant to MCC Section 2-92-385, I hereby certify that the Applicant is in compliance with MCC Section 2-92-385(b)(1) and (2), which prohibit: (i) screening job applicants based on their wage or salary history, or (ii) seeking job applicants’ wage or salary history from current or former employers. I also certify that the Applicant has adopted a policy that includes those prohibitions.

Yes

No

N/A – I am not an Applicant that is a “contractor” as defined in MCC Section 2-92-385.

This certification shall serve as the affidavit required by MCC Section 2-92-385(c)(1).

If you checked “no” to the above, please explain.

**CITY OF CHICAGO
ECONOMIC DISCLOSURE STATEMENT
AND AFFIDAVIT**

SECTION I -- GENERAL INFORMATION

A. Legal name of the Disclosing Party submitting this EDS. Include d/b/a/ if applicable:

Midwest Investing, LLC

Check ONE of the following three boxes:

Indicate whether the Disclosing Party submitting this EDS is:

1. the Applicant

OR

2. a legal entity currently holding, or anticipated to hold within six months after City action on the contract, transaction or other undertaking to which this EDS pertains (referred to below as the "Matter"), a direct or indirect interest in excess of 7.5% in the Applicant. State the Applicant's legal name: 345 N. Morgan, LLC

OR

3. a legal entity with a direct or indirect right of control of the Applicant (see Section II(B)(1)) State the legal name of the entity in which the Disclosing Party holds a right of control:

B. Business address of the Disclosing Party: 7900 Glades Road, Suite 320
Boca Raton, Florida

C. Telephone: 561.883.5959 Fax: 561.883.3138 Email: _____

D. Name of contact person: Gary R Koolik

E. Federal Employer Identification No. (if you have one): _____

F. Brief description of the Matter to which this EDS pertains. (Include project number and location of property, if applicable):

Application for planned development for the property commonly known as 345 N. Morgan St. , 311 N. Morgan St, and 1000 W. Carroll, Chicago, IL

G. Which City agency or department is requesting this EDS? DPD

If the Matter is a contract being handled by the City's Department of Procurement Services, please complete the following:

Specification # n/a and Contract # n/a

SECTION II -- DISCLOSURE OF OWNERSHIP INTERESTS

A. NATURE OF THE DISCLOSING PARTY

1. Indicate the nature of the Disclosing Party:

- Person
 - Publicly registered business corporation
 - Privately held business corporation
 - Sole proprietorship
 - General partnership
 - Limited partnership
 - Trust
 - Limited liability company
 - Limited liability partnership
 - Joint venture
 - Not-for-profit corporation
- (Is the not-for-profit corporation also a 501(c)(3))?
 Yes No
 Other (please specify)

2. For legal entities, the state (or foreign country) of incorporation or organization, if applicable:

State of Florida

3. For legal entities not organized in the State of Illinois: Has the organization registered to do business in the State of Illinois as a foreign entity?

- Yes
- No
- Organized in Illinois

B. IF THE DISCLOSING PARTY IS A LEGAL ENTITY:

1. List below the full names and titles, if applicable, of: (i) all executive officers and all directors of the entity; (ii) **for not-for-profit corporations**, all members, if any, which are legal entities (if there are no such members, write "no members which are legal entities"); (iii) **for trusts, estates or other similar entities**, the trustee, executor, administrator, or similarly situated party; (iv) **for general or limited partnerships, limited liability companies, limited liability partnerships or joint ventures**, each general partner, managing member, manager or any other person or legal entity that directly or indirectly controls the day-to-day management of the Applicant.

NOTE: Each legal entity listed below must submit an EDS on its own behalf.

Name	Title
Please refer to Applicant	

2. Please provide the following information concerning each person or legal entity having a direct or indirect, current or prospective (i.e. within 6 months after City action) beneficial interest (including ownership) in excess of 7.5% of the Applicant. Examples of such an interest include shares in a corporation, partnership interest in a partnership or joint venture, interest of a member or manager in a

limited liability company, or interest of a beneficiary of a trust, estate or other similar entity. If none, state "None."

NOTE: Each legal entity listed below may be required to submit an EDS on its own behalf.

Name	Business Address	Percentage Interest in the Applicant
NONE		

SECTION III -- INCOME OR COMPENSATION TO, OR OWNERSHIP BY, CITY ELECTED OFFICIALS

Has the Disclosing Party provided any income or compensation to any City elected official during the 12-month period preceding the date of this EDS? Yes No

Does the Disclosing Party reasonably expect to provide any income or compensation to any City elected official during the 12-month period following the date of this EDS? Yes No

If "yes" to either of the above, please identify below the name(s) of such City elected official(s) and describe such income or compensation:

Does any City elected official or, to the best of the Disclosing Party's knowledge after reasonable inquiry, any City elected official's spouse or domestic partner, have a financial interest (as defined in Chapter 2-156 of the Municipal Code of Chicago ("MCC")) in the Disclosing Party?

Yes No

If "yes," please identify below the name(s) of such City elected official(s) and/or spouse(s)/domestic partner(s) and describe the financial interest(s).

SECTION IV -- DISCLOSURE OF SUBCONTRACTORS AND OTHER RETAINED PARTIES

The Disclosing Party must disclose the name and business address of each subcontractor, attorney, lobbyist (as defined in MCC Chapter 2-156), accountant, consultant and any other person or entity whom the Disclosing Party has retained or expects to retain in connection with the Matter, as well as the nature of the relationship, and the total amount of the fees paid or estimated to be paid. The Disclosing Party is not required to disclose employees who are paid solely through the Disclosing Party's regular payroll. If the Disclosing Party is uncertain whether a disclosure is required under this Section, the Disclosing Party must either ask the City whether disclosure is required or make the disclosure.

Name (indicate whether retained or anticipated to be retained)	Business Address	Relationship to Disclosing Party (subcontractor, attorney, lobbyist, etc.)	Fees (<u>indicate whether paid or estimated.</u>) NOTE: "hourly rate" or "t.b.d." is not an acceptable response.
--	------------------	--	---

(Add sheets if necessary)

Check here if the Disclosing Party has not retained, nor expects to retain, any such persons or entities.

SECTION V -- CERTIFICATIONS

A. COURT-ORDERED CHILD SUPPORT COMPLIANCE

Under MCC Section 2-92-415, substantial owners of business entities that contract with the City must remain in compliance with their child support obligations throughout the contract's term.

Has any person who directly or indirectly owns 10% or more of the Disclosing Party been declared in arrearage on any child support obligations by any Illinois court of competent jurisdiction?

Yes No No person directly or indirectly owns 10% or more of the Disclosing Party.

If "Yes," has the person entered into a court-approved agreement for payment of all support owed and is the person in compliance with that agreement?

Yes No

B. FURTHER CERTIFICATIONS

1. [This paragraph 1 applies only if the Matter is a contract being handled by the City's Department of Procurement Services.] In the 5-year period preceding the date of this EDS, neither the Disclosing Party nor any Affiliated Entity [see definition in (5) below] has engaged, in connection with the performance of any public contract, the services of an integrity monitor, independent private sector inspector general, or integrity compliance consultant (i.e., an individual or entity with legal, auditing, investigative, or other similar skills, designated by a public agency to help the agency monitor the activity of specified agency vendors as well as help the vendors reform their business practices so they can be considered for agency contracts in the future, or continue with a contract in progress).

2. The Disclosing Party and its Affiliated Entities are not delinquent in the payment of any fine, fee, tax or other source of indebtedness owed to the City of Chicago, including, but not limited to, water and sewer charges, license fees, parking tickets, property taxes and sales taxes, nor is the Disclosing Party delinquent in the payment of any tax administered by the Illinois Department of Revenue.

3. The Disclosing Party and, if the Disclosing Party is a legal entity, all of those persons or entities identified in Section II(B)(1) of this EDS:

- a. are not presently debarred, suspended, proposed for debarment, declared ineligible or voluntarily excluded from any transactions by any federal, state or local unit of government;
- b. have not, during the 5 years before the date of this EDS, been convicted of a criminal offense, adjudged guilty, or had a civil judgment rendered against them in connection with: obtaining, attempting to obtain, or performing a public (federal, state or local) transaction or contract under a public transaction; a violation of federal or state antitrust statutes; fraud; embezzlement; theft; forgery; bribery; falsification or destruction of records; making false statements; or receiving stolen property;
- c. are not presently indicted for, or criminally or civilly charged by, a governmental entity (federal, state or local) with committing any of the offenses set forth in subparagraph (b) above;
- d. have not, during the 5 years before the date of this EDS, had one or more public transactions (federal, state or local) terminated for cause or default; and
- e. have not, during the 5 years before the date of this EDS, been convicted, adjudged guilty, or found liable in a civil proceeding, or in any criminal or civil action, including actions concerning environmental violations, instituted by the City or by the federal government, any state, or any other unit of local government.

4. The Disclosing Party understands and shall comply with the applicable requirements of MCC Chapters 2-56 (Inspector General) and 2-156 (Governmental Ethics).

5. Certifications (5), (6) and (7) concern:

- the Disclosing Party;
- any "Contractor" (meaning any contractor or subcontractor used by the Disclosing Party in connection with the Matter, including but not limited to all persons or legal entities disclosed under Section IV, "Disclosure of Subcontractors and Other Retained Parties");
- any "Affiliated Entity" (meaning a person or entity that, directly or indirectly: controls the Disclosing Party, is controlled by the Disclosing Party, or is, with the Disclosing Party, under common control of another person or entity). Indicia of control include, without limitation: interlocking management or ownership; identity of interests among family members, shared facilities and equipment; common use of employees; or organization of a business entity following the ineligibility of a business entity to do business with federal or state or local government, including the City, using substantially the same management, ownership, or principals as the ineligible entity. With respect to Contractors, the term Affiliated Entity means a person or entity that directly or indirectly controls the Contractor, is controlled by it, or, with the Contractor, is under common control of another person or entity;
- any responsible official of the Disclosing Party, any Contractor or any Affiliated Entity or any other official, agent or employee of the Disclosing Party, any Contractor or any Affiliated Entity, acting pursuant to the direction or authorization of a responsible official of the Disclosing Party, any Contractor or any Affiliated Entity (collectively "Agents").

Neither the Disclosing Party, nor any Contractor, nor any Affiliated Entity of either the Disclosing Party or any Contractor, nor any Agents have, during the 5 years before the date of this EDS, or, with respect to a Contractor, an Affiliated Entity, or an Affiliated Entity of a Contractor during the 5 years before the date of such Contractor's or Affiliated Entity's contract or engagement in connection with the Matter:

a. bribed or attempted to bribe, or been convicted or adjudged guilty of bribery or attempting to bribe, a public officer or employee of the City, the State of Illinois, or any agency of the federal government or of any state or local government in the United States of America, in that officer's or employee's official capacity;

b. agreed or colluded with other bidders or prospective bidders, or been a party to any such agreement, or been convicted or adjudged guilty of agreement or collusion among bidders or prospective bidders, in restraint of freedom of competition by agreement to bid a fixed price or otherwise; or

c. made an admission of such conduct described in subparagraph (a) or (b) above that is a matter of record, but have not been prosecuted for such conduct; or

d. violated the provisions referenced in MCC Subsection 2-92-320(a)(4)(Contracts Requiring a Base Wage); (a)(5)(Debarment Regulations); or (a)(6)(Minimum Wage Ordinance).

6. Neither the Disclosing Party, nor any Affiliated Entity or Contractor, or any of their employees, officials, agents or partners, is barred from contracting with any unit of state or local government as a result of engaging in or being convicted of (1) bid-rigging in violation of 720 ILCS 5/33E-3; (2) bid-rotating in violation of 720 ILCS 5/33E-4; or (3) any similar offense of any state or of the United States of America that contains the same elements as the offense of bid-rigging or bid-rotating.

7. Neither the Disclosing Party nor any Affiliated Entity is listed on a Sanctions List maintained by the United States Department of Commerce, State, or Treasury, or any successor federal agency.

8. [FOR APPLICANT ONLY] (i) Neither the Applicant nor any "controlling person" [see MCC Chapter 1-23, Article I for applicability and defined terms] of the Applicant is currently indicted or charged with, or has admitted guilt of, or has ever been convicted of, or placed under supervision for, any criminal offense involving actual, attempted, or conspiracy to commit bribery, theft, fraud, forgery, perjury, dishonesty or deceit against an officer or employee of the City or any "sister agency"; and (ii) the Applicant understands and acknowledges that compliance with Article I is a continuing requirement for doing business with the City. NOTE: If MCC Chapter 1-23, Article I applies to the Applicant, that Article's permanent compliance timeframe supersedes 5-year compliance timeframes in this Section V.

9. [FOR APPLICANT ONLY] The Applicant and its Affiliated Entities will not use, nor permit their subcontractors to use, any facility listed as having an active exclusion by the U.S. EPA on the federal System for Award Management ("SAM").

10. [FOR APPLICANT ONLY] The Applicant will obtain from any contractors/subcontractors hired or to be hired in connection with the Matter certifications equal in form and substance to those in Certifications (2) and (9) above and will not, without the prior written consent of the City, use any such

contractor/subcontractor that does not provide such certifications or that the Applicant has reason to believe has not provided or cannot provide truthful certifications.

11. If the Disclosing Party is unable to certify to any of the above statements in this Part B (Further Certifications), the Disclosing Party must explain below:

NONE

If the letters "NA," the word "None," or no response appears on the lines above, it will be conclusively presumed that the Disclosing Party certified to the above statements.

12. To the best of the Disclosing Party's knowledge after reasonable inquiry, the following is a complete list of all current employees of the Disclosing Party who were, at any time during the 12-month period preceding the date of this EDS, an employee, or elected or appointed official, of the City of Chicago (if none, indicate with "N/A" or "none").

NONE

13. To the best of the Disclosing Party's knowledge after reasonable inquiry, the following is a complete list of all gifts that the Disclosing Party has given or caused to be given, at any time during the 12-month period preceding the execution date of this EDS, to an employee, or elected or appointed official, of the City of Chicago. For purposes of this statement, a "gift" does not include: (i) anything made generally available to City employees or to the general public, or (ii) food or drink provided in the course of official City business and having a retail value of less than \$25 per recipient, or (iii) a political contribution otherwise duly reported as required by law (if none, indicate with "N/A" or "none"). As to any gift listed below, please also list the name of the City recipient.

NONE

C. CERTIFICATION OF STATUS AS FINANCIAL INSTITUTION

1. The Disclosing Party certifies that the Disclosing Party (check one)

is is not

a "financial institution" as defined in MCC Section 2-32-455(b).

2. If the Disclosing Party IS a financial institution, then the Disclosing Party pledges:

"We are not and will not become a predatory lender as defined in MCC Chapter 2-32. We further pledge that none of our affiliates is, and none of them will become, a predatory lender as defined in MCC Chapter 2-32. We understand that becoming a predatory lender or becoming an affiliate of a predatory lender may result in the loss of the privilege of doing business with the City."

If the Disclosing Party is unable to make this pledge because it or any of its affiliates (as defined in MCC Section 2-32-455(b)) is a predatory lender within the meaning of MCC Chapter 2-32, explain here (attach additional pages if necessary):

NA

If the letters "NA," the word "None," or no response appears on the lines above, it will be conclusively presumed that the Disclosing Party certified to the above statements.

D. CERTIFICATION REGARDING FINANCIAL INTEREST IN CITY BUSINESS

Any words or terms defined in MCC Chapter 2-156 have the same meanings if used in this Part D.

1. In accordance with MCC Section 2-156-110: To the best of the Disclosing Party's knowledge after reasonable inquiry, does any official or employee of the City have a financial interest in his or her own name or in the name of any other person or entity in the Matter?

Yes No

NOTE: If you checked "Yes" to Item D(1), proceed to Items D(2) and D(3). If you checked "No" to Item D(1), skip Items D(2) and D(3) and proceed to Part E.

2. Unless sold pursuant to a process of competitive bidding, or otherwise permitted, no City elected official or employee shall have a financial interest in his or her own name or in the name of any other person or entity in the purchase of any property that (i) belongs to the City, or (ii) is sold for taxes or assessments, or (iii) is sold by virtue of legal process at the suit of the City (collectively, "City Property Sale"). Compensation for property taken pursuant to the City's eminent domain power does not constitute a financial interest within the meaning of this Part D.

Does the Matter involve a City Property Sale?

Yes No

3. If you checked "Yes" to Item D(1), provide the names and business addresses of the City officials or employees having such financial interest and identify the nature of the financial interest:

Name	Business Address	Nature of Financial Interest

4. The Disclosing Party further certifies that no prohibited financial interest in the Matter will be acquired by any City official or employee.

E. CERTIFICATION REGARDING SLAVERY ERA BUSINESS

Please check either (1) or (2) below. If the Disclosing Party checks (2), the Disclosing Party must disclose below or in an attachment to this EDS all information required by (2). Failure to comply with these disclosure requirements may make any contract entered into with the City in connection with the Matter voidable by the City.

 X 1. The Disclosing Party verifies that the Disclosing Party has searched any and all records of the Disclosing Party and any and all predecessor entities regarding records of investments or profits from slavery or slaveholder insurance policies during the slavery era (including insurance policies issued to slaveholders that provided coverage for damage to or injury or death of their slaves), and the Disclosing Party has found no such records.

 2. The Disclosing Party verifies that, as a result of conducting the search in step (1) above, the Disclosing Party has found records of investments or profits from slavery or slaveholder insurance policies. The Disclosing Party verifies that the following constitutes full disclosure of all such records, including the names of any and all slaves or slaveholders described in those records:

SECTION VI -- CERTIFICATIONS FOR FEDERALLY FUNDED MATTERS

NOTE: If the Matter is federally funded, complete this Section VI. **If the Matter is not federally funded**, proceed to Section VII. For purposes of this Section VI, tax credits allocated by the City and proceeds of debt obligations of the City are not federal funding.

A. CERTIFICATION REGARDING LOBBYING

1. List below the names of all persons or entities registered under the federal Lobbying Disclosure Act of 1995, as amended, who have made lobbying contacts on behalf of the Disclosing Party with respect to the Matter: (Add sheets if necessary):

(If no explanation appears or begins on the lines above, or if the letters "NA" or if the word "None" appear, it will be conclusively presumed that the Disclosing Party means that NO persons or entities registered under the Lobbying Disclosure Act of 1995, as amended, have made lobbying contacts on behalf of the Disclosing Party with respect to the Matter.)

2. The Disclosing Party has not spent and will not expend any federally appropriated funds to pay any person or entity listed in paragraph A(1) above for his or her lobbying activities or to pay any person or entity to influence or attempt to influence an officer or employee of any agency, as defined by applicable federal law, a member of Congress, an officer or employee of Congress, or an employee

of a member of Congress, in connection with the award of any federally funded contract, making any federally funded grant or loan, entering into any cooperative agreement, or to extend, continue, renew, amend, or modify any federally funded contract, grant, loan, or cooperative agreement.

3. The Disclosing Party will submit an updated certification at the end of each calendar quarter in which there occurs any event that materially affects the accuracy of the statements and information set forth in paragraphs A(1) and A(2) above.

4. The Disclosing Party certifies that either: (i) it is not an organization described in section 501(c)(4) of the Internal Revenue Code of 1986; or (ii) it is an organization described in section 501(c)(4) of the Internal Revenue Code of 1986 but has not engaged and will not engage in "Lobbying Activities," as that term is defined in the Lobbying Disclosure Act of 1995, as amended.

5. If the Disclosing Party is the Applicant, the Disclosing Party must obtain certifications equal in form and substance to paragraphs A(1) through A(4) above from all subcontractors before it awards any subcontract and the Disclosing Party must maintain all such subcontractors' certifications for the duration of the Matter and must make such certifications promptly available to the City upon request.

B. CERTIFICATION REGARDING EQUAL EMPLOYMENT OPPORTUNITY

If the Matter is federally funded, federal regulations require the Applicant and all proposed subcontractors to submit the following information with their bids or in writing at the outset of negotiations.

Is the Disclosing Party the Applicant?

Yes

No

If "Yes," answer the three questions below:

1. Have you developed and do you have on file affirmative action programs pursuant to applicable federal regulations? (See 41 CFR Part 60-2.)

Yes

No

2. Have you filed with the Joint Reporting Committee, the Director of the Office of Federal Contract Compliance Programs, or the Equal Employment Opportunity Commission all reports due under the applicable filing requirements?

Yes

No

Reports not required

3. Have you participated in any previous contracts or subcontracts subject to the equal opportunity clause?

Yes

No

If you checked "No" to question (1) or (2) above, please provide an explanation:

SECTION VII -- FURTHER ACKNOWLEDGMENTS AND CERTIFICATION

The Disclosing Party understands and agrees that:

A. The certifications, disclosures, and acknowledgments contained in this EDS will become part of any contract or other agreement between the Applicant and the City in connection with the Matter, whether procurement, City assistance, or other City action, and are material inducements to the City's execution of any contract or taking other action with respect to the Matter. The Disclosing Party understands that it must comply with all statutes, ordinances, and regulations on which this EDS is based.

B. The City's Governmental Ethics Ordinance, MCC Chapter 2-156, imposes certain duties and obligations on persons or entities seeking City contracts, work, business, or transactions. The full text of this ordinance and a training program is available on line at www.cityofchicago.org/Ethics, and may also be obtained from the City's Board of Ethics, 740 N. Sedgwick St., Suite 500, Chicago, IL 60610, (312) 744-9660. The Disclosing Party must comply fully with this ordinance.

C. If the City determines that any information provided in this EDS is false, incomplete or inaccurate, any contract or other agreement in connection with which it is submitted may be rescinded or be void or voidable, and the City may pursue any remedies under the contract or agreement (if not rescinded or void), at law, or in equity, including terminating the Disclosing Party's participation in the Matter and/or declining to allow the Disclosing Party to participate in other City transactions. Remedies at law for a false statement of material fact may include incarceration and an award to the City of treble damages.

D. It is the City's policy to make this document available to the public on its Internet site and/or upon request. Some or all of the information provided in, and appended to, this EDS may be made publicly available on the Internet, in response to a Freedom of Information Act request, or otherwise. By completing and signing this EDS, the Disclosing Party waives and releases any possible rights or claims which it may have against the City in connection with the public release of information contained in this EDS and also authorizes the City to verify the accuracy of any information submitted in this EDS.

E. The information provided in this EDS must be kept current. In the event of changes, the Disclosing Party must supplement this EDS up to the time the City takes action on the Matter. If the Matter is a contract being handled by the City's Department of Procurement Services, the Disclosing Party must update this EDS as the contract requires. **NOTE:** With respect to Matters subject to MCC Chapter 1-23, Article I (imposing **PERMANENT INELIGIBILITY** for certain specified offenses), the information provided herein regarding eligibility must be kept current for a longer period, as required by MCC Chapter 1-23 and Section 2-154-020.

CERTIFICATION

Under penalty of perjury, the person signing below: (1) warrants that he/she is authorized to execute this EDS, and all applicable Appendices, on behalf of the Disclosing Party, and (2) warrants that all certifications and statements contained in this EDS, and all applicable Appendices, are true, accurate and complete as of the date furnished to the City.

Midwest Investing, LLC
(Print or type exact legal name of Disclosing Party)
By: Suprema, Inc. its manager
By: *[Signature]*
(Sign here)

Gary R Koolik
(Print or type name of person signing)
Vice President
(Print or type title of person signing)

Signed and sworn to before me on (date) February 25, 2019,

at Palm Beach County, Florida (state).

Susan V. Hatfield
Notary Public

Commission expires: September 21, 2022

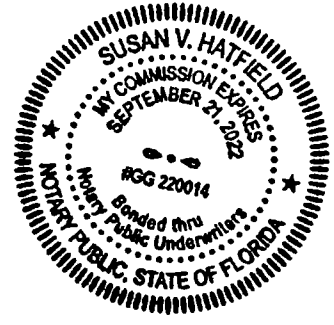

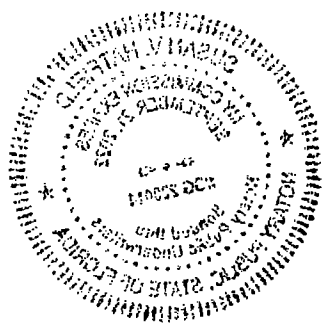

**CITY OF CHICAGO
ECONOMIC DISCLOSURE STATEMENT AND AFFIDAVIT
APPENDIX A**

**FAMILIAL RELATIONSHIPS WITH ELECTED CITY OFFICIALS
AND DEPARTMENT HEADS**

This Appendix is to be completed only by (a) the Applicant, and (b) any legal entity which has a direct ownership interest in the Applicant exceeding 7.5%. It is not to be completed by any legal entity which has only an indirect ownership interest in the Applicant.

Under MCC Section 2-154-015, the Disclosing Party must disclose whether such Disclosing Party or any "Applicable Party" or any Spouse or Domestic Partner thereof currently has a "familial relationship" with any elected city official or department head. A "familial relationship" exists if, as of the date this EDS is signed, the Disclosing Party or any "Applicable Party" or any Spouse or Domestic Partner thereof is related to the mayor, any alderman, the city clerk, the city treasurer or any city department head as spouse or domestic partner or as any of the following, whether by blood or adoption: parent, child, brother or sister, aunt or uncle, niece or nephew, grandparent, grandchild, father-in-law, mother-in-law, son-in-law, daughter-in-law, stepfather or stepmother, stepson or stepdaughter, stepbrother or stepsister or half-brother or half-sister.

"Applicable Party" means (1) all executive officers of the Disclosing Party listed in Section II.B.1.a., if the Disclosing Party is a corporation; all partners of the Disclosing Party, if the Disclosing Party is a general partnership; all general partners and limited partners of the Disclosing Party, if the Disclosing Party is a limited partnership; all managers, managing members and members of the Disclosing Party, if the Disclosing Party is a limited liability company; (2) all principal officers of the Disclosing Party; and (3) any person having more than a 7.5% ownership interest in the Disclosing Party. "Principal officers" means the president, chief operating officer, executive director, chief financial officer, treasurer or secretary of a legal entity or any person exercising similar authority.

Does the Disclosing Party or any "Applicable Party" or any Spouse or Domestic Partner thereof currently have a "familial relationship" with an elected city official or department head?

Yes

No

If yes, please identify below (1) the name and title of such person, (2) the name of the legal entity to which such person is connected; (3) the name and title of the elected city official or department head to whom such person has a familial relationship, and (4) the precise nature of such familial relationship.

**CITY OF CHICAGO
ECONOMIC DISCLOSURE STATEMENT AND AFFIDAVIT
APPENDIX B**

BUILDING CODE SCOFFLAW/PROBLEM LANDLORD CERTIFICATION

This Appendix is to be completed only by (a) the Applicant, and (b) any legal entity which has a direct ownership interest in the Applicant exceeding 7.5% (an "Owner"). It is not to be completed by any legal entity which has only an indirect ownership interest in the Applicant.

1. Pursuant to MCC Section 2-154-010, is the Applicant or any Owner identified as a building code scofflaw or problem landlord pursuant to MCC Section 2-92-416?

Yes No

2. If the Applicant is a legal entity publicly traded on any exchange, is any officer or director of the Applicant identified as a building code scofflaw or problem landlord pursuant to MCC Section 2-92-416?

Yes No The Applicant is not publicly traded on any exchange.

3. If yes to (1) or (2) above, please identify below the name of each person or legal entity identified as a building code scofflaw or problem landlord and the address of each building or buildings to which the pertinent code violations apply.

**CITY OF CHICAGO
ECONOMIC DISCLOSURE STATEMENT AND AFFIDAVIT
APPENDIX C**

PROHIBITION ON WAGE & SALARY HISTORY SCREENING - CERTIFICATION

This Appendix is to be completed only by an Applicant that is completing this EDS as a “contractor” as defined in MCC Section 2-92-385. That section, which should be consulted (www.amlegal.com), generally covers a party to any agreement pursuant to which they: (i) receive City of Chicago funds in consideration for services, work or goods provided (including for legal or other professional services), or (ii) pay the City money for a license, grant or concession allowing them to conduct a business on City premises.

On behalf of an Applicant that is a contractor pursuant to MCC Section 2-92-385, I hereby certify that the Applicant is in compliance with MCC Section 2-92-385(b)(1) and (2), which prohibit: (i) screening job applicants based on their wage or salary history, or (ii) seeking job applicants’ wage or salary history from current or former employers. I also certify that the Applicant has adopted a policy that includes those prohibitions.

Yes

No

N/A – I am not an Applicant that is a “contractor” as defined in MCC Section 2-92-385.

This certification shall serve as the affidavit required by MCC Section 2-92-385(c)(1).

If you checked “no” to the above, please explain.

**CITY OF CHICAGO
ECONOMIC DISCLOSURE STATEMENT
AND AFFIDAVIT**

SECTION I -- GENERAL INFORMATION

A. Legal name of the Disclosing Party submitting this EDS. Include d/b/a/ if applicable:

CROWN SBC INVESTOR LLC

Check ONE of the following three boxes:

Indicate whether the Disclosing Party submitting this EDS is:

1. the Applicant
OR

2. a legal entity currently holding, or anticipated to hold within six months after City action on the contract, transaction or other undertaking to which this EDS pertains (referred to below as the "Matter"), a direct or indirect interest in excess of 7.5% in the Applicant. State the Applicant's legal name: 345 N. MORGAN, LLC

OR

3. a legal entity with a direct or indirect right of control of the Applicant (see Section II(B)(1))
State the legal name of the entity in which the Disclosing Party holds a right of control:

B. Business address of the Disclosing Party: 222 North LaSalle Street, Suite 2000
Chicago, IL 60601

C. Telephone: (312)236-3003 Fax: (312) 236-3241 Email: ssandler@gouldratner.com

D. Name of contact person: Stephen P. Sandler

E. Federal Employer Identification No. (if you have one): _____

F. Brief description of the Matter to which this EDS pertains. (Include project number and location of property, if applicable):

Application for planned development for the property commonly known as 345 N. Morgan St., 311 N. Morgan St., and 1000 W. Carroll, Chicago, IL.

G. Which City agency or department is requesting this EDS? DPD

If the Matter is a contract being handled by the City's Department of Procurement Services, please complete the following:

Specification # N/A and Contract # N/A

SECTION II -- DISCLOSURE OF OWNERSHIP INTERESTS

A. NATURE OF THE DISCLOSING PARTY

1. Indicate the nature of the Disclosing Party:

- Person Limited liability company
- Publicly registered business corporation Limited liability partnership
- Privately held business corporation Joint venture
- Sole proprietorship Not-for-profit corporation
- General partnership (Is the not-for-profit corporation also a 501(c)(3))?
- Limited partnership Yes No
- Trust Other (please specify)

2. For legal entities, the state (or foreign country) of incorporation or organization, if applicable:

Delaware

3. For legal entities not organized in the State of Illinois: Has the organization registered to do business in the State of Illinois as a foreign entity?

- Yes No Organized in Illinois

B. IF THE DISCLOSING PARTY IS A LEGAL ENTITY:

1. List below the full names and titles, if applicable, of: (i) all executive officers and all directors of the entity; (ii) **for not-for-profit corporations**, all members, if any, which are legal entities (if there are no such members, write "no members which are legal entities"); (iii) **for trusts, estates or other similar entities**, the trustee, executor, administrator, or similarly situated party; (iv) **for general or limited partnerships, limited liability companies, limited liability partnerships or joint ventures**, each general partner, managing member, manager or any other person or legal entity that directly or indirectly controls the day-to-day management of the Applicant.

NOTE: Each legal entity listed below must submit an EDS on its own behalf.

Name	Title
<u>Please refer to Applicant EDS</u>	

2. Please provide the following information concerning each person or legal entity having a direct or indirect, current or prospective (i.e. within 6 months after City action) beneficial interest (including ownership) in excess of 7.5% of the Applicant. Examples of such an interest include shares in a corporation, partnership interest in a partnership or joint venture, interest of a member or manager in a

limited liability company, or interest of a beneficiary of a trust, estate or other similar entity. If none, state "None."

NOTE: Each legal entity listed below may be required to submit an EDS on its own behalf.

Name	Business Address	Percentage Interest in the Applicant
HCN111.LC	222 N LaSalle St., Ste. 2000, Chicago, Il. 60601	27.78%

SECTION III -- INCOME OR COMPENSATION TO, OR OWNERSHIP BY, CITY ELECTED OFFICIALS

Has the Disclosing Party provided any income or compensation to any City elected official during the 12-month period preceding the date of this EDS? Yes No

Does the Disclosing Party reasonably expect to provide any income or compensation to any City elected official during the 12-month period following the date of this EDS? Yes No

If "yes" to either of the above, please identify below the name(s) of such City elected official(s) and describe such income or compensation:

Does any City elected official or, to the best of the Disclosing Party's knowledge after reasonable inquiry, any City elected official's spouse or domestic partner, have a financial interest (as defined in Chapter 2-156 of the Municipal Code of Chicago ("MCC")) in the Disclosing Party?

Yes No

If "yes," please identify below the name(s) of such City elected official(s) and/or spouse(s)/domestic partner(s) and describe the financial interest(s).

SECTION IV -- DISCLOSURE OF SUBCONTRACTORS AND OTHER RETAINED PARTIES

The Disclosing Party must disclose the name and business address of each subcontractor, attorney, lobbyist (as defined in MCC Chapter 2-156), accountant, consultant and any other person or entity whom the Disclosing Party has retained or expects to retain in connection with the Matter, as well as the nature of the relationship, and the total amount of the fees paid or estimated to be paid. The Disclosing Party is not required to disclose employees who are paid solely through the Disclosing Party's regular payroll. If the Disclosing Party is uncertain whether a disclosure is required under this Section, the Disclosing Party must either ask the City whether disclosure is required or make the disclosure.

Name (indicate whether retained or anticipated to be retained)	Business Address	Relationship to Disclosing Party (subcontractor, attorney, lobbyist, etc.)	Fees (indicate whether paid or estimated.) NOTE: "hourly rate" or "t.b.d." is not an acceptable response.
--	------------------	--	---

(Add sheets if necessary)

Check here if the Disclosing Party has not retained, nor expects to retain, any such persons or entities.

SECTION V -- CERTIFICATIONS

A. COURT-ORDERED CHILD SUPPORT COMPLIANCE

Under MCC Section 2-92-415, substantial owners of business entities that contract with the City must remain in compliance with their child support obligations throughout the contract's term.

Has any person who directly or indirectly owns 10% or more of the Disclosing Party been declared in arrearage on any child support obligations by any Illinois court of competent jurisdiction?

Yes No No person directly or indirectly owns 10% or more of the Disclosing Party.

If "Yes," has the person entered into a court-approved agreement for payment of all support owed and is the person in compliance with that agreement?

Yes No

B. FURTHER CERTIFICATIONS

1 [This paragraph 1 applies only if the Matter is a contract being handled by the City's Department of Procurement Services.] In the 5-year period preceding the date of this EDS, neither the Disclosing Party nor any Affiliated Entity [see definition in (5) below] has engaged, in connection with the performance of any public contract, the services of an integrity monitor, independent private sector inspector general, or integrity compliance consultant (i.e., an individual or entity with legal, auditing, investigative, or other similar skills, designated by a public agency to help the agency monitor the activity of specified agency vendors as well as help the vendors reform their business practices so they can be considered for agency contracts in the future, or continue with a contract in progress).

2. The Disclosing Party and its Affiliated Entities are not delinquent in the payment of any fine, fee, tax or other source of indebtedness owed to the City of Chicago, including, but not limited to, water and sewer charges, license fees, parking tickets, property taxes and sales taxes, nor is the Disclosing Party delinquent in the payment of any tax administered by the Illinois Department of Revenue.

3. The Disclosing Party and, if the Disclosing Party is a legal entity, all of those persons or entities identified in Section II(B)(1) of this EDS:

a. are not presently debarred, suspended, proposed for debarment, declared ineligible or voluntarily excluded from any transactions by any federal, state or local unit of government;

b. have not, during the 5 years before the date of this EDS, been convicted of a criminal offense, adjudged guilty, or had a civil judgment rendered against them in connection with: obtaining, attempting to obtain, or performing a public (federal, state or local) transaction or contract under a public transaction; a violation of federal or state antitrust statutes; fraud; embezzlement; theft; forgery; bribery; falsification or destruction of records; making false statements; or receiving stolen property;

c. are not presently indicted for, or criminally or civilly charged by, a governmental entity (federal, state or local) with committing any of the offenses set forth in subparagraph (b) above;

d. have not, during the 5 years before the date of this EDS, had one or more public transactions (federal, state or local) terminated for cause or default; and

e. have not, during the 5 years before the date of this EDS, been convicted, adjudged guilty, or found liable in a civil proceeding, or in any criminal or civil action, including actions concerning environmental violations, instituted by the City or by the federal government, any state, or any other unit of local government.

4. The Disclosing Party understands and shall comply with the applicable requirements of MCC Chapters 2-56 (Inspector General) and 2-156 (Governmental Ethics).

5. Certifications (5), (6) and (7) concern:

- the Disclosing Party;
- any "Contractor" (meaning any contractor or subcontractor used by the Disclosing Party in connection with the Matter, including but not limited to all persons or legal entities disclosed under Section IV, "Disclosure of Subcontractors and Other Retained Parties");
- any "Affiliated Entity" (meaning a person or entity that, directly or indirectly: controls the Disclosing Party, is controlled by the Disclosing Party, or is, with the Disclosing Party, under common control of another person or entity). Indicia of control include, without limitation: interlocking management or ownership; identity of interests among family members, shared facilities and equipment; common use of employees; or organization of a business entity following the ineligibility of a business entity to do business with federal or state or local government, including the City, using substantially the same management, ownership, or principals as the ineligible entity. With respect to Contractors, the term Affiliated Entity means a person or entity that directly or indirectly controls the Contractor, is controlled by it, or, with the Contractor, is under common control of another person or entity;
- any responsible official of the Disclosing Party, any Contractor or any Affiliated Entity or any other official, agent or employee of the Disclosing Party, any Contractor or any Affiliated Entity, acting pursuant to the direction or authorization of a responsible official of the Disclosing Party, any Contractor or any Affiliated Entity (collectively "Agents").

Neither the Disclosing Party, nor any Contractor, nor any Affiliated Entity of either the Disclosing Party or any Contractor, nor any Agents have, during the 5 years before the date of this EDS, or, with respect to a Contractor, an Affiliated Entity, or an Affiliated Entity of a Contractor during the 5 years before the date of such Contractor's or Affiliated Entity's contract or engagement in connection with the Matter:

- a. bribed or attempted to bribe, or been convicted or adjudged guilty of bribery or attempting to bribe, a public officer or employee of the City, the State of Illinois, or any agency of the federal government or of any state or local government in the United States of America, in that officer's or employee's official capacity;
 - b. agreed or colluded with other bidders or prospective bidders, or been a party to any such agreement, or been convicted or adjudged guilty of agreement or collusion among bidders or prospective bidders, in restraint of freedom of competition by agreement to bid a fixed price or otherwise; or
 - c. made an admission of such conduct described in subparagraph (a) or (b) above that is a matter of record, but have not been prosecuted for such conduct; or
 - d. violated the provisions referenced in MCC Subsection 2-92-320(a)(4)(Contracts Requiring a Base Wage); (a)(5)(Debarment Regulations); or (a)(6)(Minimum Wage Ordinance).
6. Neither the Disclosing Party, nor any Affiliated Entity or Contractor, or any of their employees, officials, agents or partners, is barred from contracting with any unit of state or local government as a result of engaging in or being convicted of (1) bid-rigging in violation of 720 ILCS 5/33E-3; (2) bid-rotating in violation of 720 ILCS 5/33E-4; or (3) any similar offense of any state or of the United States of America that contains the same elements as the offense of bid-rigging or bid-rotating.
7. Neither the Disclosing Party nor any Affiliated Entity is listed on a Sanctions List maintained by the United States Department of Commerce, State, or Treasury, or any successor federal agency.
8. [FOR APPLICANT ONLY] (i) Neither the Applicant nor any "controlling person" [see MCC Chapter 1-23, Article I for applicability and defined terms] of the Applicant is currently indicted or charged with, or has admitted guilt of, or has ever been convicted of, or placed under supervision for, any criminal offense involving actual, attempted, or conspiracy to commit bribery, theft, fraud, forgery, perjury, dishonesty or deceit against an officer or employee of the City or any "sister agency"; and (ii) the Applicant understands and acknowledges that compliance with Article I is a continuing requirement for doing business with the City. NOTE: If MCC Chapter 1-23, Article I applies to the Applicant, that Article's permanent compliance timeframe supersedes 5-year compliance timeframes in this Section V.
9. [FOR APPLICANT ONLY] The Applicant and its Affiliated Entities will not use, nor permit their subcontractors to use, any facility listed as having an active exclusion by the U.S. EPA on the federal System for Award Management ("SAM").
10. [FOR APPLICANT ONLY] The Applicant will obtain from any contractors/subcontractors hired or to be hired in connection with the Matter certifications equal in form and substance to those in Certifications (2) and (9) above and will not, without the prior written consent of the City, use any such

contractor/subcontractor that does not provide such certifications or that the Applicant has reason to believe has not provided or cannot provide truthful certifications.

11. If the Disclosing Party is unable to certify to any of the above statements in this Part B (Further Certifications), the Disclosing Party must explain below:

N/A

If the letters "NA," the word "None," or no response appears on the lines above, it will be conclusively presumed that the Disclosing Party certified to the above statements.

12. To the best of the Disclosing Party's knowledge after reasonable inquiry, the following is a complete list of all current employees of the Disclosing Party who were, at any time during the 12-month period preceding the date of this EDS, an employee, or elected or appointed official, of the City of Chicago (if none, indicate with "N/A" or "none").

N/A

13. To the best of the Disclosing Party's knowledge after reasonable inquiry, the following is a complete list of all gifts that the Disclosing Party has given or caused to be given, at any time during the 12-month period preceding the execution date of this EDS, to an employee, or elected or appointed official, of the City of Chicago. For purposes of this statement, a "gift" does not include: (i) anything made generally available to City employees or to the general public, or (ii) food or drink provided in the course of official City business and having a retail value of less than \$25 per recipient, or (iii) a political contribution otherwise duly reported as required by law (if none, indicate with "N/A" or "none"). As to any gift listed below, please also list the name of the City recipient.

N/A

C. CERTIFICATION OF STATUS AS FINANCIAL INSTITUTION

1. The Disclosing Party certifies that the Disclosing Party (check one)

is is not

a "financial institution" as defined in MCC Section 2-32-455(b).

2. If the Disclosing Party IS a financial institution, then the Disclosing Party pledges:

"We are not and will not become a predatory lender as defined in MCC Chapter 2-32. We further pledge that none of our affiliates is, and none of them will become, a predatory lender as defined in MCC Chapter 2-32. We understand that becoming a predatory lender or becoming an affiliate of a predatory lender may result in the loss of the privilege of doing business with the City."

If the Disclosing Party is unable to make this pledge because it or any of its affiliates (as defined in MCC Section 2-32-455(b)) is a predatory lender within the meaning of MCC Chapter 2-32, explain here (attach additional pages if necessary):

N/A

If the letters "NA," the word "None," or no response appears on the lines above, it will be conclusively presumed that the Disclosing Party certified to the above statements.

D. CERTIFICATION REGARDING FINANCIAL INTEREST IN CITY BUSINESS

Any words or terms defined in MCC Chapter 2-156 have the same meanings if used in this Part D.

1. In accordance with MCC Section 2-156-110: To the best of the Disclosing Party's knowledge after reasonable inquiry, does any official or employee of the City have a financial interest in his or her own name or in the name of any other person or entity in the Matter?

Yes No

NOTE: If you checked "Yes" to Item D(1), proceed to Items D(2) and D(3). If you checked "No" to Item D(1), skip Items D(2) and D(3) and proceed to Part E.

2. Unless sold pursuant to a process of competitive bidding, or otherwise permitted, no City elected official or employee shall have a financial interest in his or her own name or in the name of any other person or entity in the purchase of any property that (i) belongs to the City, or (ii) is sold for taxes or assessments, or (iii) is sold by virtue of legal process at the suit of the City (collectively, "City Property Sale"). Compensation for property taken pursuant to the City's eminent domain power does not constitute a financial interest within the meaning of this Part D.

Does the Matter involve a City Property Sale?

Yes No

3. If you checked "Yes" to Item D(1), provide the names and business addresses of the City officials or employees having such financial interest and identify the nature of the financial interest:

Name	Business Address	Nature of Financial Interest

4. The Disclosing Party further certifies that no prohibited financial interest in the Matter will be acquired by any City official or employee.

E. CERTIFICATION REGARDING SLAVERY ERA BUSINESS

Please check either (1) or (2) below. If the Disclosing Party checks (2), the Disclosing Party must disclose below or in an attachment to this EDS all information required by (2). Failure to comply with these disclosure requirements may make any contract entered into with the City in connection with the Matter voidable by the City.

X 1. The Disclosing Party verifies that the Disclosing Party has searched any and all records of the Disclosing Party and any and all predecessor entities regarding records of investments or profits from slavery or slaveholder insurance policies during the slavery era (including insurance policies issued to slaveholders that provided coverage for damage to or injury or death of their slaves), and the Disclosing Party has found no such records.

 2. The Disclosing Party verifies that, as a result of conducting the search in step (1) above, the Disclosing Party has found records of investments or profits from slavery or slaveholder insurance policies. The Disclosing Party verifies that the following constitutes full disclosure of all such records, including the names of any and all slaves or slaveholders described in those records:

SECTION VI -- CERTIFICATIONS FOR FEDERALLY FUNDED MATTERS

NOTE: If the Matter is federally funded, complete this Section VI. If the Matter is not federally funded, proceed to Section VII. For purposes of this Section VI, tax credits allocated by the City and proceeds of debt obligations of the City are not federal funding.

A. CERTIFICATION REGARDING LOBBYING

1. List below the names of all persons or entities registered under the federal Lobbying Disclosure Act of 1995, as amended, who have made lobbying contacts on behalf of the Disclosing Party with respect to the Matter: (Add sheets if necessary):

(If no explanation appears or begins on the lines above, or if the letters "NA" or if the word "None" appear, it will be conclusively presumed that the Disclosing Party means that NO persons or entities registered under the Lobbying Disclosure Act of 1995, as amended, have made lobbying contacts on behalf of the Disclosing Party with respect to the Matter.)

2. The Disclosing Party has not spent and will not expend any federally appropriated funds to pay any person or entity listed in paragraph A(1) above for his or her lobbying activities or to pay any person or entity to influence or attempt to influence an officer or employee of any agency, as defined by applicable federal law, a member of Congress, an officer or employee of Congress, or an employee

of a member of Congress, in connection with the award of any federally funded contract, making any federally funded grant or loan, entering into any cooperative agreement, or to extend, continue, renew, amend, or modify any federally funded contract, grant, loan, or cooperative agreement.

3. The Disclosing Party will submit an updated certification at the end of each calendar quarter in which there occurs any event that materially affects the accuracy of the statements and information set forth in paragraphs A(1) and A(2) above.

4. The Disclosing Party certifies that either: (i) it is not an organization described in section 501(c)(4) of the Internal Revenue Code of 1986; or (ii) it is an organization described in section 501(c)(4) of the Internal Revenue Code of 1986 but has not engaged and will not engage in "Lobbying Activities," as that term is defined in the Lobbying Disclosure Act of 1995, as amended.

5. If the Disclosing Party is the Applicant, the Disclosing Party must obtain certifications equal in form and substance to paragraphs A(1) through A(4) above from all subcontractors before it awards any subcontract and the Disclosing Party must maintain all such subcontractors' certifications for the duration of the Matter and must make such certifications promptly available to the City upon request.

B. CERTIFICATION REGARDING EQUAL EMPLOYMENT OPPORTUNITY

If the Matter is federally funded, federal regulations require the Applicant and all proposed subcontractors to submit the following information with their bids or in writing at the outset of negotiations.

Is the Disclosing Party the Applicant?

Yes No

If "Yes," answer the three questions below:

1. Have you developed and do you have on file affirmative action programs pursuant to applicable federal regulations? (See 41 CFR Part 60-2.)

Yes No

2. Have you filed with the Joint Reporting Committee, the Director of the Office of Federal Contract Compliance Programs, or the Equal Employment Opportunity Commission all reports due under the applicable filing requirements?

Yes No Reports not required

3. Have you participated in any previous contracts or subcontracts subject to the equal opportunity clause?

Yes No

If you checked "No" to question (1) or (2) above, please provide an explanation:

SECTION VII -- FURTHER ACKNOWLEDGMENTS AND CERTIFICATION

The Disclosing Party understands and agrees that:

A. The certifications, disclosures, and acknowledgments contained in this EDS will become part of any contract or other agreement between the Applicant and the City in connection with the Matter, whether procurement, City assistance, or other City action, and are material inducements to the City's execution of any contract or taking other action with respect to the Matter. The Disclosing Party understands that it must comply with all statutes, ordinances, and regulations on which this EDS is based.

B. The City's Governmental Ethics Ordinance, MCC Chapter 2-156, imposes certain duties and obligations on persons or entities seeking City contracts, work, business, or transactions. The full text of this ordinance and a training program is available on line at www.cityofchicago.org/Ethics, and may also be obtained from the City's Board of Ethics, 740 N. Sedgwick St., Suite 500, Chicago, IL 60610, (312) 744-9660. The Disclosing Party must comply fully with this ordinance.

C. If the City determines that any information provided in this EDS is false, incomplete or inaccurate, any contract or other agreement in connection with which it is submitted may be rescinded or be void or voidable, and the City may pursue any remedies under the contract or agreement (if not rescinded or void), at law, or in equity, including terminating the Disclosing Party's participation in the Matter and/or declining to allow the Disclosing Party to participate in other City transactions. Remedies at law for a false statement of material fact may include incarceration and an award to the City of treble damages.

D. It is the City's policy to make this document available to the public on its Internet site and/or upon request. Some or all of the information provided in, and appended to, this EDS may be made publicly available on the Internet, in response to a Freedom of Information Act request, or otherwise. By completing and signing this EDS, the Disclosing Party waives and releases any possible rights or claims which it may have against the City in connection with the public release of information contained in this EDS and also authorizes the City to verify the accuracy of any information submitted in this EDS.

E. The information provided in this EDS must be kept current. In the event of changes, the Disclosing Party must supplement this EDS up to the time the City takes action on the Matter. If the Matter is a contract being handled by the City's Department of Procurement Services, the Disclosing Party must update this EDS as the contract requires. **NOTE:** With respect to Matters subject to MCC Chapter 1-23, Article I (imposing **PERMANENT INELIGIBILITY** for certain specified offenses), the information provided herein regarding eligibility must be kept current for a longer period, as required by MCC Chapter 1-23 and Section 2-154-020.

CERTIFICATION

Under penalty of perjury, the person signing below: (1) warrants that he/she is authorized to execute this EDS, and all applicable Appendices, on behalf of the Disclosing Party, and (2) warrants that all certifications and statements contained in this EDS, and all applicable Appendices, are true, accurate and complete as of the date furnished to the City.

CROWN SBC INVESTOR LLC

(Print or type exact legal name of Disclosing Party)

By: 
(Sign here)

A. Steven Crown

(Print or type name of person signing)

Manager of HCC Manager LLC, Manager of Crown SBC Investor LLC

(Print or type title of person signing)

Signed and sworn to before me on (date) February 21, 2019

at Cook County, Illinois (state).

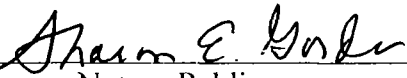
Notary Public



Commission expires: 11.13.21

OFFICIAL SEAL
SHAWN E GORDON
NOTARY PUBLIC - STATE OF ILLINOIS
MY COMMISSION EXPIRES 01/31/2011

**CITY OF CHICAGO
ECONOMIC DISCLOSURE STATEMENT AND AFFIDAVIT
APPENDIX A**

**FAMILIAL RELATIONSHIPS WITH ELECTED CITY OFFICIALS
AND DEPARTMENT HEADS**

This Appendix is to be completed only by (a) the Applicant, and (b) any legal entity which has a direct ownership interest in the Applicant exceeding 7.5%. It is not to be completed by any legal entity which has only an indirect ownership interest in the Applicant.

Under MCC Section 2-154-015, the Disclosing Party must disclose whether such Disclosing Party or any "Applicable Party" or any Spouse or Domestic Partner thereof currently has a "familial relationship" with any elected city official or department head. A "familial relationship" exists if, as of the date this EDS is signed, the Disclosing Party or any "Applicable Party" or any Spouse or Domestic Partner thereof is related to the mayor, any alderman, the city clerk, the city treasurer or any city department head as spouse or domestic partner or as any of the following, whether by blood or adoption: parent, child, brother or sister, aunt or uncle, niece or nephew, grandparent, grandchild, father-in-law, mother-in-law, son-in-law, daughter-in-law, stepfather or stepmother, stepson or stepdaughter, stepbrother or stepsister or half-brother or half-sister.

"Applicable Party" means (1) all executive officers of the Disclosing Party listed in Section II.B.1.a., if the Disclosing Party is a corporation; all partners of the Disclosing Party, if the Disclosing Party is a general partnership; all general partners and limited partners of the Disclosing Party, if the Disclosing Party is a limited partnership; all managers, managing members and members of the Disclosing Party, if the Disclosing Party is a limited liability company; (2) all principal officers of the Disclosing Party; and (3) any person having more than a 7.5% ownership interest in the Disclosing Party. "Principal officers" means the president, chief operating officer, executive director, chief financial officer, treasurer or secretary of a legal entity or any person exercising similar authority.

Does the Disclosing Party or any "Applicable Party" or any Spouse or Domestic Partner thereof currently have a "familial relationship" with an elected city official or department head?

[] Yes [X] No

If yes, please identify below (1) the name and title of such person, (2) the name of the legal entity to which such person is connected; (3) the name and title of the elected city official or department head to whom such person has a familial relationship, and (4) the precise nature of such familial relationship.

**CITY OF CHICAGO
ECONOMIC DISCLOSURE STATEMENT AND AFFIDAVIT
APPENDIX B**

BUILDING CODE SCOFFLAW/PROBLEM LANDLORD CERTIFICATION

This Appendix is to be completed only by (a) the Applicant, and (b) any legal entity which has a direct ownership interest in the Applicant exceeding 7.5% (an "Owner"). It is not to be completed by any legal entity which has only an indirect ownership interest in the Applicant.

1. Pursuant to MCC Section 2-154-010, is the Applicant or any Owner identified as a building code scofflaw or problem landlord pursuant to MCC Section 2-92-416?

Yes No

2. If the Applicant is a legal entity publicly traded on any exchange, is any officer or director of the Applicant identified as a building code scofflaw or problem landlord pursuant to MCC Section 2-92-416?

Yes No The Applicant is not publicly traded on any exchange.

3. If yes to (1) or (2) above, please identify below the name of each person or legal entity identified as a building code scofflaw or problem landlord and the address of each building or buildings to which the pertinent code violations apply.

**CITY OF CHICAGO
ECONOMIC DISCLOSURE STATEMENT AND AFFIDAVIT
APPENDIX C**

PROHIBITION ON WAGE & SALARY HISTORY SCREENING - CERTIFICATION

This Appendix is to be completed only by an Applicant that is completing this EDS as a “contractor” as defined in MCC Section 2-92-385. That section, which should be consulted (www.amlegal.com), generally covers a party to any agreement pursuant to which they: (i) receive City of Chicago funds in consideration for services, work or goods provided (including for legal or other professional services), or (ii) pay the City money for a license, grant or concession allowing them to conduct a business on City premises.

On behalf of an Applicant that is a contractor pursuant to MCC Section 2-92-385, I hereby certify that the Applicant is in compliance with MCC Section 2-92-385(b)(1) and (2), which prohibit: (i) screening job applicants based on their wage or salary history, or (ii) seeking job applicants’ wage or salary history from current or former employers. I also certify that the Applicant has adopted a policy that includes those prohibitions.

Yes

No

N/A -- I am not an Applicant that is a “contractor” as defined in MCC Section 2-92-385.

This certification shall serve as the affidavit required by MCC Section 2-92-385(c)(1).

If you checked “no” to the above, please explain.

**CITY OF CHICAGO
ECONOMIC DISCLOSURE STATEMENT
AND AFFIDAVIT**

SECTION I -- GENERAL INFORMATION

A. Legal name of the Disclosing Party submitting this EDS. Include d/b/a/ if applicable:

HCNI I LLC

Check ONE of the following three boxes:

Indicate whether the Disclosing Party submitting this EDS is:

1. the Applicant

OR

2. a legal entity currently holding, or anticipated to hold within six months after City action on the contract, transaction or other undertaking to which this EDS pertains (referred to below as the "Matter"), a direct or indirect interest in excess of 7.5% in the Applicant. State the Applicant's legal name: 345 N. MORGAN, LLC

OR

3. a legal entity with a direct or indirect right of control of the Applicant (see Section II(B)(1))
State the legal name of the entity in which the Disclosing Party holds a right of control:

B. Business address of the Disclosing Party: 222 North LaSalle Street, Suite 2000
Chicago, IL 60601

C. Telephone: (312)236-3003 Fax: (312) 236-3241 Email: ssandler@gouldratner.com

D. Name of contact person: Stephen P. Sandler

E. Federal Employer Identification No. (if you have one): _____

F. Brief description of the Matter to which this EDS pertains. (Include project number and location of property, if applicable):

Application for planned development for the property commonly known as 345 N. Morgan St., 311 N. Morgan St., and 1000 W. Carroll, Chicago, IL

G. Which City agency or department is requesting this EDS? DPD

If the Matter is a contract being handled by the City's Department of Procurement Services, please complete the following:

Specification # N/A and Contract # N/A

SECTION II -- DISCLOSURE OF OWNERSHIP INTERESTS

A. NATURE OF THE DISCLOSING PARTY

1. Indicate the nature of the Disclosing Party:

- Person
- Limited liability company
- Publicly registered business corporation
- Limited liability partnership
- Privately held business corporation
- Joint venture
- Sole proprietorship
- Not-for-profit corporation
- General partnership
- (Is the not-for-profit corporation also a 501(c)(3))?
- Limited partnership
- Yes No
- Trust
- Other (please specify)

2. For legal entities, the state (or foreign country) of incorporation or organization, if applicable:

Illinois

3. For legal entities not organized in the State of Illinois: Has the organization registered to do business in the State of Illinois as a foreign entity?

- Yes
- No
- Organized in Illinois

B IF THE DISCLOSING PARTY IS A LEGAL ENTITY:

1. List below the full names and titles, if applicable, of: (i) all executive officers and all directors of the entity; (ii) **for not-for-profit corporations**, all members, if any, which are legal entities (if there are no such members, write "no members which are legal entities"); (iii) **for trusts, estates or other similar entities**, the trustee, executor, administrator, or similarly situated party; (iv) **for general or limited partnerships, limited liability companies, limited liability partnerships or joint ventures**, each general partner, managing member, manager or any other person or legal entity that directly or indirectly controls the day-to-day management of the Applicant.

NOTE: Each legal entity listed below must submit an EDS on its own behalf.

Name	Title
------	-------

Please refer to Applicant EDS

2. Please provide the following information concerning each person or legal entity having a direct or indirect, current or prospective (i.e. within 6 months after City action) beneficial interest (including ownership) in excess of 7.5% of the Applicant. Examples of such an interest include shares in a corporation, partnership interest in a partnership or joint venture, interest of a member or manager in a

limited liability company, or interest of a beneficiary of a trust, estate or other similar entity. If none, state "None."

NOTE: Each legal entity listed below may be required to submit an EDS on its own behalf.

Name	Business Address	Percentage Interest in the Applicant
NONE		

SECTION III -- INCOME OR COMPENSATION TO, OR OWNERSHIP BY, CITY ELECTED OFFICIALS

Has the Disclosing Party provided any income or compensation to any City elected official during the 12-month period preceding the date of this EDS? Yes No

Does the Disclosing Party reasonably expect to provide any income or compensation to any City elected official during the 12-month period following the date of this EDS? Yes No

If "yes" to either of the above, please identify below the name(s) of such City elected official(s) and describe such income or compensation:

Does any City elected official or, to the best of the Disclosing Party's knowledge after reasonable inquiry, any City elected official's spouse or domestic partner, have a financial interest (as defined in Chapter 2-156 of the Municipal Code of Chicago ("MCC")) in the Disclosing Party?

Yes No

If "yes," please identify below the name(s) of such City elected official(s) and/or spouse(s)/domestic partner(s) and describe the financial interest(s).

SECTION IV -- DISCLOSURE OF SUBCONTRACTORS AND OTHER RETAINED PARTIES

The Disclosing Party must disclose the name and business address of each subcontractor, attorney, lobbyist (as defined in MCC Chapter 2-156), accountant, consultant and any other person or entity whom the Disclosing Party has retained or expects to retain in connection with the Matter, as well as the nature of the relationship, and the total amount of the fees paid or estimated to be paid. The Disclosing Party is not required to disclose employees who are paid solely through the Disclosing Party's regular payroll. If the Disclosing Party is uncertain whether a disclosure is required under this Section, the Disclosing Party must either ask the City whether disclosure is required or make the disclosure.

Name (indicate whether retained or anticipated to be retained)	Business Address	Relationship to Disclosing Party (subcontractor, attorney, lobbyist, etc.)	Fees (indicate whether paid or estimated.) NOTE: "hourly rate" or "t.b.d." is not an acceptable response.
--	------------------	--	---

(Add sheets if necessary)

Check here if the Disclosing Party has not retained, nor expects to retain, any such persons or entities.

SECTION V -- CERTIFICATIONS

A. COURT-ORDERED CHILD SUPPORT COMPLIANCE

Under MCC Section 2-92-415, substantial owners of business entities that contract with the City must remain in compliance with their child support obligations throughout the contract's term.

Has any person who directly or indirectly owns 10% or more of the Disclosing Party been declared in arrearage on any child support obligations by any Illinois court of competent jurisdiction?

Yes No No person directly or indirectly owns 10% or more of the Disclosing Party.

If "Yes," has the person entered into a court-approved agreement for payment of all support owed and is the person in compliance with that agreement?

Yes No

B. FURTHER CERTIFICATIONS

1. [This paragraph 1 applies only if the Matter is a contract being handled by the City's Department of Procurement Services.] In the 5-year period preceding the date of this EDS, neither the Disclosing Party nor any Affiliated Entity [see definition in (5) below] has engaged, in connection with the performance of any public contract, the services of an integrity monitor, independent private sector inspector general, or integrity compliance consultant (i.e., an individual or entity with legal, auditing, investigative, or other similar skills, designated by a public agency to help the agency monitor the activity of specified agency vendors as well as help the vendors reform their business practices so they can be considered for agency contracts in the future, or continue with a contract in progress).

2. The Disclosing Party and its Affiliated Entities are not delinquent in the payment of any fine, fee, tax or other source of indebtedness owed to the City of Chicago, including, but not limited to, water and sewer charges, license fees, parking tickets, property taxes and sales taxes, nor is the Disclosing Party delinquent in the payment of any tax administered by the Illinois Department of Revenue.

3. The Disclosing Party and, if the Disclosing Party is a legal entity, all of those persons or entities identified in Section II(B)(1) of this EDS:

- a. are not presently debarred, suspended, proposed for debarment, declared ineligible or voluntarily excluded from any transactions by any federal, state or local unit of government;
- b. have not, during the 5 years before the date of this EDS, been convicted of a criminal offense, adjudged guilty, or had a civil judgment rendered against them in connection with: obtaining, attempting to obtain, or performing a public (federal, state or local) transaction or contract under a public transaction; a violation of federal or state antitrust statutes; fraud; embezzlement; theft; forgery; bribery; falsification or destruction of records; making false statements; or receiving stolen property;
- c. are not presently indicted for, or criminally or civilly charged by, a governmental entity (federal, state or local) with committing any of the offenses set forth in subparagraph (b) above;
- d. have not, during the 5 years before the date of this EDS, had one or more public transactions (federal, state or local) terminated for cause or default; and
- e. have not, during the 5 years before the date of this EDS, been convicted, adjudged guilty, or found liable in a civil proceeding, or in any criminal or civil action, including actions concerning environmental violations, instituted by the City or by the federal government, any state, or any other unit of local government.

4. The Disclosing Party understands and shall comply with the applicable requirements of MCC Chapters 2-56 (Inspector General) and 2-156 (Governmental Ethics).

5. Certifications (5), (6) and (7) concern:

- the Disclosing Party;
- any "Contractor" (meaning any contractor or subcontractor used by the Disclosing Party in connection with the Matter, including but not limited to all persons or legal entities disclosed under Section IV, "Disclosure of Subcontractors and Other Retained Parties");
- any "Affiliated Entity" (meaning a person or entity that, directly or indirectly: controls the Disclosing Party, is controlled by the Disclosing Party, or is, with the Disclosing Party, under common control of another person or entity). Indicia of control include, without limitation: interlocking management or ownership; identity of interests among family members, shared facilities and equipment; common use of employees; or organization of a business entity following the ineligibility of a business entity to do business with federal or state or local government, including the City, using substantially the same management, ownership, or principals as the ineligible entity. With respect to Contractors, the term Affiliated Entity means a person or entity that directly or indirectly controls the Contractor, is controlled by it, or, with the Contractor, is under common control of another person or entity;
- any responsible official of the Disclosing Party, any Contractor or any Affiliated Entity or any other official, agent or employee of the Disclosing Party, any Contractor or any Affiliated Entity, acting pursuant to the direction or authorization of a responsible official of the Disclosing Party, any Contractor or any Affiliated Entity (collectively "Agents").

Neither the Disclosing Party, nor any Contractor, nor any Affiliated Entity of either the Disclosing Party or any Contractor, nor any Agents have, during the 5 years before the date of this EDS, or, with respect to a Contractor, an Affiliated Entity, or an Affiliated Entity of a Contractor during the 5 years before the date of such Contractor's or Affiliated Entity's contract or engagement in connection with the Matter:

- a. bribed or attempted to bribe, or been convicted or adjudged guilty of bribery or attempting to bribe, a public officer or employee of the City, the State of Illinois, or any agency of the federal government or of any state or local government in the United States of America, in that officer's or employee's official capacity;
 - b. agreed or colluded with other bidders or prospective bidders, or been a party to any such agreement, or been convicted or adjudged guilty of agreement or collusion among bidders or prospective bidders, in restraint of freedom of competition by agreement to bid a fixed price or otherwise; or
 - c. made an admission of such conduct described in subparagraph (a) or (b) above that is a matter of record, but have not been prosecuted for such conduct; or
 - d. violated the provisions referenced in MCC Subsection 2-92-320(a)(4)(Contracts Requiring a Base Wage); (a)(5)(Debarment Regulations); or (a)(6)(Minimum Wage Ordinance).
6. Neither the Disclosing Party, nor any Affiliated Entity or Contractor, or any of their employees, officials, agents or partners, is barred from contracting with any unit of state or local government as a result of engaging in or being convicted of (1) bid-rigging in violation of 720 ILCS 5/33E-3; (2) bid-rotating in violation of 720 ILCS 5/33E-4; or (3) any similar offense of any state or of the United States of America that contains the same elements as the offense of bid-rigging or bid-rotating.
7. Neither the Disclosing Party nor any Affiliated Entity is listed on a Sanctions List maintained by the United States Department of Commerce, State, or Treasury, or any successor federal agency.
8. [FOR APPLICANT ONLY] (i) Neither the Applicant nor any "controlling person" [see MCC Chapter 1-23, Article I for applicability and defined terms] of the Applicant is currently indicted or charged with, or has admitted guilt of, or has ever been convicted of, or placed under supervision for, any criminal offense involving actual, attempted, or conspiracy to commit bribery, theft, fraud, forgery, perjury, dishonesty or deceit against an officer or employee of the City or any "sister agency"; and (ii) the Applicant understands and acknowledges that compliance with Article I is a continuing requirement for doing business with the City. NOTE: If MCC Chapter 1-23, Article I applies to the Applicant, that Article's permanent compliance timeframe supersedes 5-year compliance timeframes in this Section V.
9. [FOR APPLICANT ONLY] The Applicant and its Affiliated Entities will not use, nor permit their subcontractors to use, any facility listed as having an active exclusion by the U.S. EPA on the federal System for Award Management ("SAM").
10. [FOR APPLICANT ONLY] The Applicant will obtain from any contractors/subcontractors hired or to be hired in connection with the Matter certifications equal in form and substance to those in Certifications (2) and (9) above and will not, without the prior written consent of the City, use any such

contractor/subcontractor that does not provide such certifications or that the Applicant has reason to believe has not provided or cannot provide truthful certifications.

11. If the Disclosing Party is unable to certify to any of the above statements in this Part B (Further Certifications), the Disclosing Party must explain below:

N/A

If the letters "NA," the word "None," or no response appears on the lines above, it will be conclusively presumed that the Disclosing Party certified to the above statements.

12. To the best of the Disclosing Party's knowledge after reasonable inquiry, the following is a complete list of all current employees of the Disclosing Party who were, at any time during the 12-month period preceding the date of this EDS, an employee, or elected or appointed official, of the City of Chicago (if none, indicate with "N/A" or "none").

N/A

13. To the best of the Disclosing Party's knowledge after reasonable inquiry, the following is a complete list of all gifts that the Disclosing Party has given or caused to be given, at any time during the 12-month period preceding the execution date of this EDS, to an employee, or elected or appointed official, of the City of Chicago. For purposes of this statement, a "gift" does not include: (i) anything made generally available to City employees or to the general public, or (ii) food or drink provided in the course of official City business and having a retail value of less than \$25 per recipient, or (iii) a political contribution otherwise duly reported as required by law (if none, indicate with "N/A" or "none"). As to any gift listed below, please also list the name of the City recipient.

N/A

C. CERTIFICATION OF STATUS AS FINANCIAL INSTITUTION

1. The Disclosing Party certifies that the Disclosing Party (check one)

is is not

a "financial institution" as defined in MCC Section 2-32-455(b).

2. If the Disclosing Party IS a financial institution, then the Disclosing Party pledges:

"We are not and will not become a predatory lender as defined in MCC Chapter 2-32. We further pledge that none of our affiliates is, and none of them will become, a predatory lender as defined in MCC Chapter 2-32. We understand that becoming a predatory lender or becoming an affiliate of a predatory lender may result in the loss of the privilege of doing business with the City."

If the Disclosing Party is unable to make this pledge because it or any of its affiliates (as defined in MCC Section 2-32-455(b)) is a predatory lender within the meaning of MCC Chapter 2-32, explain here (attach additional pages if necessary):

N/A _____

If the letters "NA," the word "None," or no response appears on the lines above, it will be conclusively presumed that the Disclosing Party certified to the above statements.

D. CERTIFICATION REGARDING FINANCIAL INTEREST IN CITY BUSINESS

Any words or terms defined in MCC Chapter 2-156 have the same meanings if used in this Part D.

1. In accordance with MCC Section 2-156-110: To the best of the Disclosing Party's knowledge after reasonable inquiry, does any official or employee of the City have a financial interest in his or her own name or in the name of any other person or entity in the Matter?

Yes No

NOTE: If you checked "Yes" to Item D(1), proceed to Items D(2) and D(3). If you checked "No" to Item D(1), skip Items D(2) and D(3) and proceed to Part E.

2. Unless sold pursuant to a process of competitive bidding, or otherwise permitted, no City elected official or employee shall have a financial interest in his or her own name or in the name of any other person or entity in the purchase of any property that (i) belongs to the City, or (ii) is sold for taxes or assessments, or (iii) is sold by virtue of legal process at the suit of the City (collectively, "City Property Sale"). Compensation for property taken pursuant to the City's eminent domain power does not constitute a financial interest within the meaning of this Part D.

Does the Matter involve a City Property Sale?

Yes No

3. If you checked "Yes" to Item D(1), provide the names and business addresses of the City officials or employees having such financial interest and identify the nature of the financial interest:

Name	Business Address	Nature of Financial Interest
_____	_____	_____
_____	_____	_____
_____	_____	_____

4. The Disclosing Party further certifies that no prohibited financial interest in the Matter will be acquired by any City official or employee.

E. CERTIFICATION REGARDING SLAVERY ERA BUSINESS

Please check either (1) or (2) below. If the Disclosing Party checks (2), the Disclosing Party must disclose below or in an attachment to this EDS all information required by (2). Failure to comply with these disclosure requirements may make any contract entered into with the City in connection with the Matter voidable by the City.

X 1. The Disclosing Party verifies that the Disclosing Party has searched any and all records of the Disclosing Party and any and all predecessor entities regarding records of investments or profits from slavery or slaveholder insurance policies during the slavery era (including insurance policies issued to slaveholders that provided coverage for damage to or injury or death of their slaves), and the Disclosing Party has found no such records.

___ 2. The Disclosing Party verifies that, as a result of conducting the search in step (1) above, the Disclosing Party has found records of investments or profits from slavery or slaveholder insurance policies. The Disclosing Party verifies that the following constitutes full disclosure of all such records, including the names of any and all slaves or slaveholders described in those records:

SECTION VI -- CERTIFICATIONS FOR FEDERALLY FUNDED MATTERS

NOTE: If the Matter is federally funded, complete this Section VI. **If the Matter is not federally funded,** proceed to Section VII. For purposes of this Section VI, tax credits allocated by the City and proceeds of debt obligations of the City are not federal funding.

A. CERTIFICATION REGARDING LOBBYING

1. List below the names of all persons or entities registered under the federal Lobbying Disclosure Act of 1995, as amended, who have made lobbying contacts on behalf of the Disclosing Party with respect to the Matter: (Add sheets if necessary):

(If no explanation appears or begins on the lines above, or if the letters "NA" or if the word "None" appear, it will be conclusively presumed that the Disclosing Party means that NO persons or entities registered under the Lobbying Disclosure Act of 1995, as amended, have made lobbying contacts on behalf of the Disclosing Party with respect to the Matter.)

2. The Disclosing Party has not spent and will not expend any federally appropriated funds to pay any person or entity listed in paragraph A(1) above for his or her lobbying activities or to pay any person or entity to influence or attempt to influence an officer or employee of any agency, as defined by applicable federal law, a member of Congress, an officer or employee of Congress, or an employee

of a member of Congress, in connection with the award of any federally funded contract, making any federally funded grant or loan, entering into any cooperative agreement, or to extend, continue, renew, amend, or modify any federally funded contract, grant, loan, or cooperative agreement.

3. The Disclosing Party will submit an updated certification at the end of each calendar quarter in which there occurs any event that materially affects the accuracy of the statements and information set forth in paragraphs A(1) and A(2) above.

4. The Disclosing Party certifies that either: (i) it is not an organization described in section 501(c)(4) of the Internal Revenue Code of 1986; or (ii) it is an organization described in section 501(c)(4) of the Internal Revenue Code of 1986 but has not engaged and will not engage in "Lobbying Activities," as that term is defined in the Lobbying Disclosure Act of 1995, as amended.

5. If the Disclosing Party is the Applicant, the Disclosing Party must obtain certifications equal in form and substance to paragraphs A(1) through A(4) above from all subcontractors before it awards any subcontract and the Disclosing Party must maintain all such subcontractors' certifications for the duration of the Matter and must make such certifications promptly available to the City upon request.

B. CERTIFICATION REGARDING EQUAL EMPLOYMENT OPPORTUNITY

If the Matter is federally funded, federal regulations require the Applicant and all proposed subcontractors to submit the following information with their bids or in writing at the outset of negotiations.

Is the Disclosing Party the Applicant?

Yes No

If "Yes," answer the three questions below:

1. Have you developed and do you have on file affirmative action programs pursuant to applicable federal regulations? (See 41 CFR Part 60-2.)

Yes No

2. Have you filed with the Joint Reporting Committee, the Director of the Office of Federal Contract Compliance Programs, or the Equal Employment Opportunity Commission all reports due under the applicable filing requirements?

Yes No Reports not required

3. Have you participated in any previous contracts or subcontracts subject to the equal opportunity clause?

Yes No

If you checked "No" to question (1) or (2) above, please provide an explanation:

SECTION VII -- FURTHER ACKNOWLEDGMENTS AND CERTIFICATION

The Disclosing Party understands and agrees that:

A. The certifications, disclosures, and acknowledgments contained in this EDS will become part of any contract or other agreement between the Applicant and the City in connection with the Matter, whether procurement, City assistance, or other City action, and are material inducements to the City's execution of any contract or taking other action with respect to the Matter. The Disclosing Party understands that it must comply with all statutes, ordinances, and regulations on which this EDS is based.

B. The City's Governmental Ethics Ordinance, MCC Chapter 2-156, imposes certain duties and obligations on persons or entities seeking City contracts, work, business, or transactions. The full text of this ordinance and a training program is available on line at www.cityofchicago.org/Ethics, and may also be obtained from the City's Board of Ethics, 740 N. Sedgwick St., Suite 500, Chicago, IL 60610, (312) 744-9660. The Disclosing Party must comply fully with this ordinance.

C. If the City determines that any information provided in this EDS is false, incomplete or inaccurate, any contract or other agreement in connection with which it is submitted may be rescinded or be void or voidable, and the City may pursue any remedies under the contract or agreement (if not rescinded or void), at law, or in equity, including terminating the Disclosing Party's participation in the Matter and/or declining to allow the Disclosing Party to participate in other City transactions. Remedies at law for a false statement of material fact may include incarceration and an award to the City of treble damages.

D. It is the City's policy to make this document available to the public on its Internet site and/or upon request. Some or all of the information provided in, and appended to, this EDS may be made publicly available on the Internet, in response to a Freedom of Information Act request, or otherwise. By completing and signing this EDS, the Disclosing Party waives and releases any possible rights or claims which it may have against the City in connection with the public release of information contained in this EDS and also authorizes the City to verify the accuracy of any information submitted in this EDS.

E. The information provided in this EDS must be kept current. In the event of changes, the Disclosing Party must supplement this EDS up to the time the City takes action on the Matter. If the Matter is a contract being handled by the City's Department of Procurement Services, the Disclosing Party must update this EDS as the contract requires. **NOTE:** With respect to Matters subject to MCC Chapter 1-23, Article I (imposing **PERMANENT INELIGIBILITY** for certain specified offenses), the information provided herein regarding eligibility must be kept current for a longer period, as required by MCC Chapter 1-23 and Section 2-154-020.

CERTIFICATION

Under penalty of perjury, the person signing below: (1) warrants that he/she is authorized to execute this EDS, and all applicable Appendices, on behalf of the Disclosing Party, and (2) warrants that all certifications and statements contained in this EDS, and all applicable Appendices, are true, accurate and complete as of the date furnished to the City.

HCNI I LLC
(Print or type exact legal name of Disclosing Party)

By: 
(Sign here)

A. Steven Crown
(Print or type name of person signing)

Manager of HCC Manager LLC, Manager of HCNI I LLC
(Print or type title of person signing)

Signed and sworn to before me on (date) February 21, 2019,

at Cook County, Illinois (state).

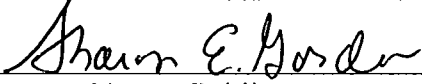
Notary Public

Commission expires: 11.13.21

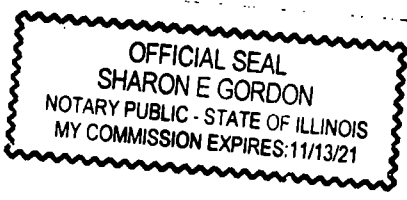

OFFICIAL SEAL
SHARON L. O'NEILL
NEW YORK STATE PUBLIC DEFENDER
COMMISSION EXPIRES 12/31/2011

**CITY OF CHICAGO
ECONOMIC DISCLOSURE STATEMENT AND AFFIDAVIT
APPENDIX A**

**FAMILIAL RELATIONSHIPS WITH ELECTED CITY OFFICIALS
AND DEPARTMENT HEADS**

This Appendix is to be completed only by (a) the Applicant, and (b) any legal entity which has a direct ownership interest in the Applicant exceeding 7.5%. It is not to be completed by any legal entity which has only an indirect ownership interest in the Applicant.

Under MCC Section 2-154-015, the Disclosing Party must disclose whether such Disclosing Party or any "Applicable Party" or any Spouse or Domestic Partner thereof currently has a "familial relationship" with any elected city official or department head. A "familial relationship" exists if, as of the date this EDS is signed, the Disclosing Party or any "Applicable Party" or any Spouse or Domestic Partner thereof is related to the mayor, any alderman, the city clerk, the city treasurer or any city department head as spouse or domestic partner or as any of the following, whether by blood or adoption: parent, child, brother or sister, aunt or uncle, niece or nephew, grandparent, grandchild, father-in-law, mother-in-law, son-in-law, daughter-in-law, stepfather or stepmother, stepson or stepdaughter, stepbrother or stepsister or half-brother or half-sister.

"Applicable Party" means (1) all executive officers of the Disclosing Party listed in Section II.B.1.a., if the Disclosing Party is a corporation; all partners of the Disclosing Party, if the Disclosing Party is a general partnership; all general partners and limited partners of the Disclosing Party, if the Disclosing Party is a limited partnership; all managers, managing members and members of the Disclosing Party, if the Disclosing Party is a limited liability company; (2) all principal officers of the Disclosing Party; and (3) any person having more than a 7.5% ownership interest in the Disclosing Party. "Principal officers" means the president, chief operating officer, executive director, chief financial officer, treasurer or secretary of a legal entity or any person exercising similar authority.

Does the Disclosing Party or any "Applicable Party" or any Spouse or Domestic Partner thereof currently have a "familial relationship" with an elected city official or department head?

Yes No

If yes, please identify below (1) the name and title of such person, (2) the name of the legal entity to which such person is connected; (3) the name and title of the elected city official or department head to whom such person has a familial relationship, and (4) the precise nature of such familial relationship.

**CITY OF CHICAGO
ECONOMIC DISCLOSURE STATEMENT AND AFFIDAVIT
APPENDIX B**

BUILDING CODE SCOFFLAW/PROBLEM LANDLORD CERTIFICATION

This Appendix is to be completed only by (a) the Applicant, and (b) any legal entity which has a direct ownership interest in the Applicant exceeding 7.5% (an "Owner"). It is not to be completed by any legal entity which has only an indirect ownership interest in the Applicant.

1. Pursuant to MCC Section 2-154-010, is the Applicant or any Owner identified as a building code scofflaw or problem landlord pursuant to MCC Section 2-92-416?

Yes No

2. If the Applicant is a legal entity publicly traded on any exchange, is any officer or director of the Applicant identified as a building code scofflaw or problem landlord pursuant to MCC Section 2-92-416?

Yes No The Applicant is not publicly traded on any exchange.

3. If yes to (1) or (2) above, please identify below the name of each person or legal entity identified as a building code scofflaw or problem landlord and the address of each building or buildings to which the pertinent code violations apply.

**CITY OF CHICAGO
ECONOMIC DISCLOSURE STATEMENT AND AFFIDAVIT
APPENDIX C**

PROHIBITION ON WAGE & SALARY HISTORY SCREENING - CERTIFICATION

This Appendix is to be completed only by an Applicant that is completing this EDS as a “contractor” as defined in MCC Section 2-92-385. That section, which should be consulted (www.amlegal.com), generally covers a party to any agreement pursuant to which they: (i) receive City of Chicago funds in consideration for services, work or goods provided (including for legal or other professional services), or (ii) pay the City money for a license, grant or concession allowing them to conduct a business on City premises.

On behalf of an Applicant that is a contractor pursuant to MCC Section 2-92-385, I hereby certify that the Applicant is in compliance with MCC Section 2-92-385(b)(1) and (2), which prohibit: (i) screening job applicants based on their wage or salary history, or (ii) seeking job applicants’ wage or salary history from current or former employers. I also certify that the Applicant has adopted a policy that includes those prohibitions.

Yes

No

N/A – I am not an Applicant that is a “contractor” as defined in MCC Section 2-92-385.

This certification shall serve as the affidavit required by MCC Section 2-92-385(c)(1).

If you checked “no” to the above, please explain.

**CITY OF CHICAGO
ECONOMIC DISCLOSURE STATEMENT
AND AFFIDAVIT**

SECTION I -- GENERAL INFORMATION

A. Legal name of the Disclosing Party submitting this EDS. Include d/b/a/ if applicable:

Wanxiang America Real Estate Group, LLC

Check ONE of the following three boxes:

Indicate whether the Disclosing Party submitting this EDS is:

1. the Applicant

OR

2. a legal entity currently holding, or anticipated to hold within six months after City action on the contract, transaction or other undertaking to which this EDS pertains (referred to below as the "Matter"), a direct or indirect interest in excess of 7.5% in the Applicant. State the Applicant's legal name: 345 N. Morgan, LLC

OR

3. a legal entity with a direct or indirect right of control of the Applicant (see Section II(B)(1))
State the legal name of the entity in which the Disclosing Party holds a right of control:

B. Business address of the Disclosing Party: 150 N. Riverside Plaza, Suite 1810

Chicago, IL 60606

C. Telephone: 847-921-7064 Fax: 847-931-4339 Email: lkrueger@wanxiang.com

D. Name of contact person: Lawrence J. Krueger

E. Federal Employer Identification No. (if you have one): _____

F. Brief description of the Matter to which this EDS pertains. (Include project number and location of property, if applicable):

Application for planned development for property commonly known as 345 N. Morgan St., 311 N. Morgan St., and 1000 W. Carroll, Chicago, IL.

G. Which City agency or department is requesting this EDS? DPD

If the Matter is a contract being handled by the City's Department of Procurement Services, please complete the following:

Specification # N/A and Contract # N/A

SECTION II -- DISCLOSURE OF OWNERSHIP INTERESTS

A. NATURE OF THE DISCLOSING PARTY

1. Indicate the nature of the Disclosing Party:

- Person Limited liability company
- Publicly registered business corporation Limited liability partnership
- Privately held business corporation Joint venture
- Sole proprietorship Not-for-profit corporation
- General partnership (Is the not-for-profit corporation also a 501(c)(3))?
- Limited partnership Yes No
- Trust Other (please specify)

2. For legal entities, the state (or foreign country) of incorporation or organization, if applicable:

Illinois

3. For legal entities not organized in the State of Illinois: Has the organization registered to do business in the State of Illinois as a foreign entity?

- Yes No Organized in Illinois

B. IF THE DISCLOSING PARTY IS A LEGAL ENTITY:

1. List below the full names and titles, if applicable, of: (i) all executive officers and all directors of the entity; (ii) **for not-for-profit corporations**, all members, if any, which are legal entities (if there are no such members, write "no members which are legal entities"); (iii) **for trusts, estates or other similar entities**, the trustee, executor, administrator, or similarly situated party; (iv) **for general or limited partnerships, limited liability companies, limited liability partnerships or joint ventures**, each general partner, managing member, manager or any other person or legal entity that directly or indirectly controls the day-to-day management of the Applicant.

NOTE: Each legal entity listed below must submit an EDS on its own behalf.

Name	Title
Lawrence J. Krueger	Managing Director

2. Please provide the following information concerning each person or legal entity having a direct or indirect, current or prospective (i.e. within 6 months after City action) beneficial interest (including ownership) in excess of 7.5% of the Applicant. Examples of such an interest include shares in a corporation, partnership interest in a partnership or joint venture, interest of a member or manager in a

limited liability company, or interest of a beneficiary of a trust, estate or other similar entity. If none, state "None."

NOTE: Each legal entity listed below may be required to submit an EDS on its own behalf.

Name	Business Address	Percentage Interest in the Applicant
------	------------------	--------------------------------------

See attached Exhibit A

SECTION III -- INCOME OR COMPENSATION TO, OR OWNERSHIP BY, CITY ELECTED OFFICIALS

Has the Disclosing Party provided any income or compensation to any City elected official during the 12-month period preceding the date of this EDS? Yes No

Does the Disclosing Party reasonably expect to provide any income or compensation to any City elected official during the 12-month period following the date of this EDS? Yes No

If "yes" to either of the above, please identify below the name(s) of such City elected official(s) and describe such income or compensation:

Does any City elected official or, to the best of the Disclosing Party's knowledge after reasonable inquiry, any City elected official's spouse or domestic partner, have a financial interest (as defined in Chapter 2-156 of the Municipal Code of Chicago ("MCC")) in the Disclosing Party?

Yes No

If "yes," please identify below the name(s) of such City elected official(s) and/or spouse(s)/domestic partner(s) and describe the financial interest(s).

SECTION IV -- DISCLOSURE OF SUBCONTRACTORS AND OTHER RETAINED PARTIES

The Disclosing Party must disclose the name and business address of each subcontractor, attorney, lobbyist (as defined in MCC Chapter 2-156), accountant, consultant and any other person or entity whom the Disclosing Party has retained or expects to retain in connection with the Matter, as well as the nature of the relationship, and the total amount of the fees paid or estimated to be paid. The Disclosing Party is not required to disclose employees who are paid solely through the Disclosing Party's regular payroll. If the Disclosing Party is uncertain whether a disclosure is required under this Section, the Disclosing Party must either ask the City whether disclosure is required or make the disclosure.

Name (indicate whether retained or anticipated to be retained)	Business Address	Relationship to Disclosing Party (subcontractor, attorney, lobbyist, etc.)	Fees (indicate whether paid or estimated.) NOTE: "hourly rate" or "t.b.d." is not an acceptable response.
--	------------------	--	---

(Add sheets if necessary)

Check here if the Disclosing Party has not retained, nor expects to retain, any such persons or entities.

SECTION V -- CERTIFICATIONS

A. COURT-ORDERED CHILD SUPPORT COMPLIANCE

Under MCC Section 2-92-415, substantial owners of business entities that contract with the City must remain in compliance with their child support obligations throughout the contract's term.

Has any person who directly or indirectly owns 10% or more of the Disclosing Party been declared in arrearage on any child support obligations by any Illinois court of competent jurisdiction?

Yes No No person directly or indirectly owns 10% or more of the Disclosing Party.

If "Yes," has the person entered into a court-approved agreement for payment of all support owed and is the person in compliance with that agreement?

Yes No

B. FURTHER CERTIFICATIONS

1. [This paragraph 1 applies only if the Matter is a contract being handled by the City's Department of Procurement Services.] In the 5-year period preceding the date of this EDS, neither the Disclosing Party nor any Affiliated Entity [see definition in (5) below] has engaged, in connection with the performance of any public contract, the services of an integrity monitor, independent private sector inspector general, or integrity compliance consultant (i.e., an individual or entity with legal, auditing, investigative, or other similar skills, designated by a public agency to help the agency monitor the activity of specified agency vendors as well as help the vendors reform their business practices so they can be considered for agency contracts in the future, or continue with a contract in progress).

2. The Disclosing Party and its Affiliated Entities are not delinquent in the payment of any fine, fee, tax or other source of indebtedness owed to the City of Chicago, including, but not limited to, water and sewer charges, license fees, parking tickets, property taxes and sales taxes, nor is the Disclosing Party delinquent in the payment of any tax administered by the Illinois Department of Revenue.

3. The Disclosing Party and, if the Disclosing Party is a legal entity, all of those persons or entities identified in Section II(B)(1) of this EDS:
- a. are not presently debarred, suspended, proposed for debarment, declared ineligible or voluntarily excluded from any transactions by any federal, state or local unit of government;
 - b. have not, during the 5 years before the date of this EDS, been convicted of a criminal offense, adjudged guilty, or had a civil judgment rendered against them in connection with: obtaining, attempting to obtain, or performing a public (federal, state or local) transaction or contract under a public transaction; a violation of federal or state antitrust statutes; fraud; embezzlement; theft; forgery; bribery; falsification or destruction of records; making false statements; or receiving stolen property;
 - c. are not presently indicted for, or criminally or civilly charged by, a governmental entity (federal, state or local) with committing any of the offenses set forth in subparagraph (b) above;
 - d. have not, during the 5 years before the date of this EDS, had one or more public transactions (federal, state or local) terminated for cause or default; and
 - e. have not, during the 5 years before the date of this EDS, been convicted, adjudged guilty, or found liable in a civil proceeding, or in any criminal or civil action, including actions concerning environmental violations, instituted by the City or by the federal government, any state, or any other unit of local government.
4. The Disclosing Party understands and shall comply with the applicable requirements of MCC Chapters 2-56 (Inspector General) and 2-156 (Governmental Ethics).
5. Certifications (5), (6) and (7) concern:
- the Disclosing Party;
 - any "Contractor" (meaning any contractor or subcontractor used by the Disclosing Party in connection with the Matter, including but not limited to all persons or legal entities disclosed under Section IV, "Disclosure of Subcontractors and Other Retained Parties");
 - any "Affiliated Entity" (meaning a person or entity that, directly or indirectly: controls the Disclosing Party, is controlled by the Disclosing Party, or is, with the Disclosing Party, under common control of another person or entity). Indicia of control include, without limitation: interlocking management or ownership; identity of interests among family members, shared facilities and equipment; common use of employees; or organization of a business entity following the ineligibility of a business entity to do business with federal or state or local government, including the City, using substantially the same management, ownership, or principals as the ineligible entity. With respect to Contractors, the term Affiliated Entity means a person or entity that directly or indirectly controls the Contractor, is controlled by it, or, with the Contractor, is under common control of another person or entity;
 - any responsible official of the Disclosing Party, any Contractor or any Affiliated Entity or any other official, agent or employee of the Disclosing Party, any Contractor or any Affiliated Entity, acting pursuant to the direction or authorization of a responsible official of the Disclosing Party, any Contractor or any Affiliated Entity (collectively "Agents").

Neither the Disclosing Party, nor any Contractor, nor any Affiliated Entity of either the Disclosing Party or any Contractor, nor any Agents have, during the 5 years before the date of this EDS, or, with respect to a Contractor, an Affiliated Entity, or an Affiliated Entity of a Contractor during the 5 years before the date of such Contractor's or Affiliated Entity's contract or engagement in connection with the Matter:

a. bribed or attempted to bribe, or been convicted or adjudged guilty of bribery or attempting to bribe, a public officer or employee of the City, the State of Illinois, or any agency of the federal government or of any state or local government in the United States of America, in that officer's or employee's official capacity;

b. agreed or colluded with other bidders or prospective bidders, or been a party to any such agreement, or been convicted or adjudged guilty of agreement or collusion among bidders or prospective bidders, in restraint of freedom of competition by agreement to bid a fixed price or otherwise; or

c. made an admission of such conduct described in subparagraph (a) or (b) above that is a matter of record, but have not been prosecuted for such conduct; or

d. violated the provisions referenced in MCC Subsection 2-92-320(a)(4)(Contracts Requiring a Base Wage); (a)(5)(Debarment Regulations); or (a)(6)(Minimum Wage Ordinance).

6. Neither the Disclosing Party, nor any Affiliated Entity or Contractor, or any of their employees, officials, agents or partners, is barred from contracting with any unit of state or local government as a result of engaging in or being convicted of (1) bid-rigging in violation of 720 ILCS 5/33E-3; (2) bid-rotating in violation of 720 ILCS 5/33E-4; or (3) any similar offense of any state or of the United States of America that contains the same elements as the offense of bid-rigging or bid-rotating.

7. Neither the Disclosing Party nor any Affiliated Entity is listed on a Sanctions List maintained by the United States Department of Commerce, State, or Treasury, or any successor federal agency.

8. [FOR APPLICANT ONLY] (i) Neither the Applicant nor any "controlling person" [see MCC Chapter 1-23, Article I for applicability and defined terms] of the Applicant is currently indicted or charged with, or has admitted guilt of, or has ever been convicted of, or placed under supervision for, any criminal offense involving actual, attempted, or conspiracy to commit bribery, theft, fraud, forgery, perjury, dishonesty or deceit against an officer or employee of the City or any "sister agency"; and (ii) the Applicant understands and acknowledges that compliance with Article I is a continuing requirement for doing business with the City. NOTE: If MCC Chapter 1-23, Article I applies to the Applicant, that Article's permanent compliance timeframe supersedes 5-year compliance timeframes in this Section V.

9. [FOR APPLICANT ONLY] The Applicant and its Affiliated Entities will not use, nor permit their subcontractors to use, any facility listed as having an active exclusion by the U.S. EPA on the federal System for Award Management ("SAM").

10. [FOR APPLICANT ONLY] The Applicant will obtain from any contractors/subcontractors hired or to be hired in connection with the Matter certifications equal in form and substance to those in Certifications (2) and (9) above and will not, without the prior written consent of the City, use any such

contractor/subcontractor that does not provide such certifications or that the Applicant has reason to believe has not provided or cannot provide truthful certifications.

11. If the Disclosing Party is unable to certify to any of the above statements in this Part B (Further Certifications), the Disclosing Party must explain below:

N/A

If the letters "NA," the word "None," or no response appears on the lines above, it will be conclusively presumed that the Disclosing Party certified to the above statements.

12. To the best of the Disclosing Party's knowledge after reasonable inquiry, the following is a complete list of all current employees of the Disclosing Party who were, at any time during the 12-month period preceding the date of this EDS, an employee, or elected or appointed official, of the City of Chicago (if none, indicate with "N/A" or "none").

N/A

13. To the best of the Disclosing Party's knowledge after reasonable inquiry, the following is a complete list of all gifts that the Disclosing Party has given or caused to be given, at any time during the 12-month period preceding the execution date of this EDS, to an employee, or elected or appointed official, of the City of Chicago. For purposes of this statement, a "gift" does not include: (i) anything made generally available to City employees or to the general public, or (ii) food or drink provided in the course of official City business and having a retail value of less than \$25 per recipient, or (iii) a political contribution otherwise duly reported as required by law (if none, indicate with "N/A" or "none"). As to any gift listed below, please also list the name of the City recipient.

N/A

C. CERTIFICATION OF STATUS AS FINANCIAL INSTITUTION

1. The Disclosing Party certifies that the Disclosing Party (check one)

is is not

a "financial institution" as defined in MCC Section 2-32-455(b).

2. If the Disclosing Party IS a financial institution, then the Disclosing Party pledges:

"We are not and will not become a predatory lender as defined in MCC Chapter 2-32. We further pledge that none of our affiliates is, and none of them will become, a predatory lender as defined in MCC Chapter 2-32. We understand that becoming a predatory lender or becoming an affiliate of a predatory lender may result in the loss of the privilege of doing business with the City."

If the Disclosing Party is unable to make this pledge because it or any of its affiliates (as defined in MCC Section 2-32-455(b)) is a predatory lender within the meaning of MCC Chapter 2-32, explain here (attach additional pages if necessary):

N/A

If the letters "NA," the word "None," or no response appears on the lines above, it will be conclusively presumed that the Disclosing Party certified to the above statements.

D. CERTIFICATION REGARDING FINANCIAL INTEREST IN CITY BUSINESS

Any words or terms defined in MCC Chapter 2-156 have the same meanings if used in this Part D.

1. In accordance with MCC Section 2-156-110: To the best of the Disclosing Party's knowledge after reasonable inquiry, does any official or employee of the City have a financial interest in his or her own name or in the name of any other person or entity in the Matter?

Yes

No

NOTE: If you checked "Yes" to Item D(1), proceed to Items D(2) and D(3). If you checked "No" to Item D(1), skip Items D(2) and D(3) and proceed to Part E.

2. Unless sold pursuant to a process of competitive bidding, or otherwise permitted, no City elected official or employee shall have a financial interest in his or her own name or in the name of any other person or entity in the purchase of any property that (i) belongs to the City, or (ii) is sold for taxes or assessments, or (iii) is sold by virtue of legal process at the suit of the City (collectively, "City Property Sale"). Compensation for property taken pursuant to the City's eminent domain power does not constitute a financial interest within the meaning of this Part D.

Does the Matter involve a City Property Sale?

Yes

No

3. If you checked "Yes" to Item D(1), provide the names and business addresses of the City officials or employees having such financial interest and identify the nature of the financial interest:

Name

Business Address

Nature of Financial Interest

4. The Disclosing Party further certifies that no prohibited financial interest in the Matter will be acquired by any City official or employee.

E. CERTIFICATION REGARDING SLAVERY ERA BUSINESS

Please check either (1) or (2) below. If the Disclosing Party checks (2), the Disclosing Party must disclose below or in an attachment to this EDS all information required by (2). Failure to comply with these disclosure requirements may make any contract entered into with the City in connection with the Matter voidable by the City.

X 1. The Disclosing Party verifies that the Disclosing Party has searched any and all records of the Disclosing Party and any and all predecessor entities regarding records of investments or profits from slavery or slaveholder insurance policies during the slavery era (including insurance policies issued to slaveholders that provided coverage for damage to or injury or death of their slaves), and the Disclosing Party has found no such records.

2. The Disclosing Party verifies that, as a result of conducting the search in step (1) above, the Disclosing Party has found records of investments or profits from slavery or slaveholder insurance policies. The Disclosing Party verifies that the following constitutes full disclosure of all such records, including the names of any and all slaves or slaveholders described in those records:

SECTION VI -- CERTIFICATIONS FOR FEDERALLY FUNDED MATTERS

NOTE: If the Matter is federally funded, complete this Section VI. **If the Matter is not federally funded**, proceed to Section VII. For purposes of this Section VI, tax credits allocated by the City and proceeds of debt obligations of the City are not federal funding.

A. CERTIFICATION REGARDING LOBBYING

1. List below the names of all persons or entities registered under the federal Lobbying Disclosure Act of 1995, as amended, who have made lobbying contacts on behalf of the Disclosing Party with respect to the Matter: (Add sheets if necessary):

(If no explanation appears or begins on the lines above, or if the letters "NA" or if the word "None" appear, it will be conclusively presumed that the Disclosing Party means that NO persons or entities registered under the Lobbying Disclosure Act of 1995, as amended, have made lobbying contacts on behalf of the Disclosing Party with respect to the Matter.)

2. The Disclosing Party has not spent and will not expend any federally appropriated funds to pay any person or entity listed in paragraph A(1) above for his or her lobbying activities or to pay any person or entity to influence or attempt to influence an officer or employee of any agency, as defined by applicable federal law, a member of Congress, an officer or employee of Congress, or an employee

of a member of Congress, in connection with the award of any federally funded contract, making any federally funded grant or loan, entering into any cooperative agreement, or to extend, continue, renew, amend, or modify any federally funded contract, grant, loan, or cooperative agreement.

3. The Disclosing Party will submit an updated certification at the end of each calendar quarter in which there occurs any event that materially affects the accuracy of the statements and information set forth in paragraphs A(1) and A(2) above.

4. The Disclosing Party certifies that either: (i) it is not an organization described in section 501(c)(4) of the Internal Revenue Code of 1986; or (ii) it is an organization described in section 501(c)(4) of the Internal Revenue Code of 1986 but has not engaged and will not engage in "Lobbying Activities," as that term is defined in the Lobbying Disclosure Act of 1995, as amended.

5. If the Disclosing Party is the Applicant, the Disclosing Party must obtain certifications equal in form and substance to paragraphs A(1) through A(4) above from all subcontractors before it awards any subcontract and the Disclosing Party must maintain all such subcontractors' certifications for the duration of the Matter and must make such certifications promptly available to the City upon request.

B. CERTIFICATION REGARDING EQUAL EMPLOYMENT OPPORTUNITY

If the Matter is federally funded, federal regulations require the Applicant and all proposed subcontractors to submit the following information with their bids or in writing at the outset of negotiations.

Is the Disclosing Party the Applicant?

Yes

No

If "Yes," answer the three questions below:

1. Have you developed and do you have on file affirmative action programs pursuant to applicable federal regulations? (See 41 CFR Part 60-2.)

Yes

No

2. Have you filed with the Joint Reporting Committee, the Director of the Office of Federal Contract Compliance Programs, or the Equal Employment Opportunity Commission all reports due under the applicable filing requirements?

Yes

No

Reports not required

3. Have you participated in any previous contracts or subcontracts subject to the equal opportunity clause?

Yes

No

If you checked "No" to question (1) or (2) above, please provide an explanation:

SECTION VII -- FURTHER ACKNOWLEDGMENTS AND CERTIFICATION

The Disclosing Party understands and agrees that:

A. The certifications, disclosures, and acknowledgments contained in this EDS will become part of any contract or other agreement between the Applicant and the City in connection with the Matter, whether procurement, City assistance, or other City action, and are material inducements to the City's execution of any contract or taking other action with respect to the Matter. The Disclosing Party understands that it must comply with all statutes, ordinances, and regulations on which this EDS is based.

B. The City's Governmental Ethics Ordinance, MCC Chapter 2-156, imposes certain duties and obligations on persons or entities seeking City contracts, work, business, or transactions. The full text of this ordinance and a training program is available on line at www.cityofchicago.org/Ethics, and may also be obtained from the City's Board of Ethics, 740 N. Sedgwick St., Suite 500, Chicago, IL 60610, (312) 744-9660. The Disclosing Party must comply fully with this ordinance.

C. If the City determines that any information provided in this EDS is false, incomplete or inaccurate, any contract or other agreement in connection with which it is submitted may be rescinded or be void or voidable, and the City may pursue any remedies under the contract or agreement (if not rescinded or void), at law, or in equity, including terminating the Disclosing Party's participation in the Matter and/or declining to allow the Disclosing Party to participate in other City transactions. Remedies at law for a false statement of material fact may include incarceration and an award to the City of treble damages.

D. It is the City's policy to make this document available to the public on its Internet site and/or upon request. Some or all of the information provided in, and appended to, this EDS may be made publicly available on the Internet, in response to a Freedom of Information Act request, or otherwise. By completing and signing this EDS, the Disclosing Party waives and releases any possible rights or claims which it may have against the City in connection with the public release of information contained in this EDS and also authorizes the City to verify the accuracy of any information submitted in this EDS.

E. The information provided in this EDS must be kept current. In the event of changes, the Disclosing Party must supplement this EDS up to the time the City takes action on the Matter. If the Matter is a contract being handled by the City's Department of Procurement Services, the Disclosing Party must update this EDS as the contract requires. **NOTE:** With respect to Matters subject to MCC Chapter 1-23, Article I (imposing **PERMANENT INELIGIBILITY** for certain specified offenses), the information provided herein regarding eligibility must be kept current for a longer period, as required by MCC Chapter 1-23 and Section 2-154-020.

CERTIFICATION

Under penalty of perjury, the person signing below: (1) warrants that he/she is authorized to execute this EDS, and all applicable Appendices, on behalf of the Disclosing Party, and (2) warrants that all certifications and statements contained in this EDS, and all applicable Appendices, are true, accurate and complete as of the date furnished to the City.

Wanxiang America Real Estate Group, LLC

(Print or type exact legal name of Disclosing Party)

By: 
(Sign here)

Lawrence J. Krueger

(Print or type name of person signing)

Managing Director

(Print or type title of person signing)

Signed and sworn to before me on (date) 2/26/19,

at Cook County, Illinois (state).

Raquel E. Cortes
Notary Public



Commission expires: 4/30/22

OFFICIAL SEAL
RACHUEL E. CORTES
NOTARY PUBLIC STATE OF ILLINOIS
MY COMMISSION EXPIRES 04/15/2025

**CITY OF CHICAGO
ECONOMIC DISCLOSURE STATEMENT AND AFFIDAVIT
APPENDIX A**

**FAMILIAL RELATIONSHIPS WITH ELECTED CITY OFFICIALS
AND DEPARTMENT HEADS**

This Appendix is to be completed only by (a) the Applicant, and (b) any legal entity which has a direct ownership interest in the Applicant exceeding 7.5%. It is not to be completed by any legal entity which has only an indirect ownership interest in the Applicant.

Under MCC Section 2-154-015, the Disclosing Party must disclose whether such Disclosing Party or any "Applicable Party" or any Spouse or Domestic Partner thereof currently has a "familial relationship" with any elected city official or department head. A "familial relationship" exists if, as of the date this EDS is signed, the Disclosing Party or any "Applicable Party" or any Spouse or Domestic Partner thereof is related to the mayor, any alderman, the city clerk, the city treasurer or any city department head as spouse or domestic partner or as any of the following, whether by blood or adoption: parent, child, brother or sister, aunt or uncle, niece or nephew, grandparent, grandchild, father-in-law, mother-in-law, son-in-law, daughter-in-law, stepfather or stepmother, stepson or stepdaughter, stepbrother or stepsister or half-brother or half-sister.

"Applicable Party" means (1) all executive officers of the Disclosing Party listed in Section II.B.1.a., if the Disclosing Party is a corporation; all partners of the Disclosing Party, if the Disclosing Party is a general partnership; all general partners and limited partners of the Disclosing Party, if the Disclosing Party is a limited partnership; all managers, managing members and members of the Disclosing Party, if the Disclosing Party is a limited liability company; (2) all principal officers of the Disclosing Party; and (3) any person having more than a 7.5% ownership interest in the Disclosing Party. "Principal officers" means the president, chief operating officer, executive director, chief financial officer, treasurer or secretary of a legal entity or any person exercising similar authority.

Does the Disclosing Party or any "Applicable Party" or any Spouse or Domestic Partner thereof currently have a "familial relationship" with an elected city official or department head?

Yes

No

If yes, please identify below (1) the name and title of such person, (2) the name of the legal entity to which such person is connected; (3) the name and title of the elected city official or department head to whom such person has a familial relationship, and (4) the precise nature of such familial relationship.

**CITY OF CHICAGO
ECONOMIC DISCLOSURE STATEMENT AND AFFIDAVIT
APPENDIX B**

BUILDING CODE SCOFFLAW/PROBLEM LANDLORD CERTIFICATION

This Appendix is to be completed only by (a) the Applicant, and (b) any legal entity which has a direct ownership interest in the Applicant exceeding 7.5% (an "Owner"). It is not to be completed by any legal entity which has only an indirect ownership interest in the Applicant.

1. Pursuant to MCC Section 2-154-010, is the Applicant or any Owner identified as a building code scofflaw or problem landlord pursuant to MCC Section 2-92-416?

Yes No

2. If the Applicant is a legal entity publicly traded on any exchange, is any officer or director of the Applicant identified as a building code scofflaw or problem landlord pursuant to MCC Section 2-92-416?

Yes No The Applicant is not publicly traded on any exchange.

3. If yes to (1) or (2) above, please identify below the name of each person or legal entity identified as a building code scofflaw or problem landlord and the address of each building or buildings to which the pertinent code violations apply.

**CITY OF CHICAGO
ECONOMIC DISCLOSURE STATEMENT AND AFFIDAVIT
APPENDIX C**

PROHIBITION ON WAGE & SALARY HISTORY SCREENING - CERTIFICATION

This Appendix is to be completed only by an Applicant that is completing this EDS as a “contractor” as defined in MCC Section 2-92-385. That section, which should be consulted (www.amlegal.com), generally covers a party to any agreement pursuant to which they: (i) receive City of Chicago funds in consideration for services, work or goods provided (including for legal or other professional services), or (ii) pay the City money for a license, grant or concession allowing them to conduct a business on City premises.

On behalf of an Applicant that is a contractor pursuant to MCC Section 2-92-385, I hereby certify that the Applicant is in compliance with MCC Section 2-92-385(b)(1) and (2), which prohibit: (i) screening job applicants based on their wage or salary history, or (ii) seeking job applicants’ wage or salary history from current or former employers. I also certify that the Applicant has adopted a policy that includes those prohibitions.

Yes

No

N/A – I am not an Applicant that is a “contractor” as defined in MCC Section 2-92-385.

This certification shall serve as the affidavit required by MCC Section 2-92-385(c)(1).

If you checked “no” to the above, please explain.

**CITY OF CHICAGO
ECONOMIC DISCLOSURE STATEMENT
AND AFFIDAVIT**

SECTION I -- GENERAL INFORMATION

A. Legal name of the Disclosing Party submitting this EDS. Include d/b/a/ if applicable:

Wanxiang America Corporation

Check ONE of the following three boxes:

Indicate whether the Disclosing Party submitting this EDS is:

1. the Applicant

OR

2. a legal entity currently holding, or anticipated to hold within six months after City action on the contract, transaction or other undertaking to which this EDS pertains (referred to below as the "Matter"), a direct or indirect interest in excess of 7.5% in the Applicant. State the Applicant's legal name: 345 N. Morgan, LLC

OR

3. a legal entity with a direct or indirect right of control of the Applicant (see Section II(B)(1))
State the legal name of the entity in which the Disclosing Party holds a right of control:

B. Business address of the Disclosing Party: 88 Airport Road

Elgin, IL 60123

C. Telephone: 847-921-7064 Fax: 847-931-4339 Email: lkrueger@wanxiang.com

D. Name of contact person: Lawrence J. Krueger

E. Federal Employer Identification No. (if you have one): _____

F. Brief description of the Matter to which this EDS pertains. (Include project number and location of property, if applicable):

Application for planned development for the property commonly known as 345 N. Morgan St., 311 N. Morgan St., and 1000 W. Carroll, Chicago, IL

G. Which City agency or department is requesting this EDS? DPD

If the Matter is a contract being handled by the City's Department of Procurement Services, please complete the following:

Specification # N/A and Contract # N/A

SECTION II -- DISCLOSURE OF OWNERSHIP INTERESTS

A. NATURE OF THE DISCLOSING PARTY

1. Indicate the nature of the Disclosing Party:

- Person
- Publicly registered business corporation
- Privately held business corporation
- Sole proprietorship
- General partnership
- Limited partnership
- Trust
- Limited liability company
- Limited liability partnership
- Joint venture
- Not-for-profit corporation
- (Is the not-for-profit corporation also a 501(c)(3))?
 Yes No
- Other (please specify)

2. For legal entities, the state (or foreign country) of incorporation or organization, if applicable:

Kentucky

3. For legal entities not organized in the State of Illinois: Has the organization registered to do business in the State of Illinois as a foreign entity?

- Yes
- No
- Organized in Illinois

B. IF THE DISCLOSING PARTY IS A LEGAL ENTITY:

1. List below the full names and titles, if applicable, of: (i) all executive officers and all directors of the entity; (ii) **for not-for-profit corporations**, all members, if any, which are legal entities (if there are no such members, write "no members which are legal entities"); (iii) **for trusts, estates or other similar entities**, the trustee, executor, administrator, or similarly situated party; (iv) **for general or limited partnerships, limited liability companies, limited liability partnerships or joint ventures**, each general partner, managing member, manager or any other person or legal entity that directly or indirectly controls the day-to-day management of the Applicant.

NOTE: Each legal entity listed below must submit an EDS on its own behalf.

Name	Title
Pin Ni	President/Director
Gary Wetzell	Secretary/Director
Weiding Lu	Chairman/Director

2. Please provide the following information concerning each person or legal entity having a direct or indirect, current or prospective (i.e. within 6 months after City action) beneficial interest (including ownership) in excess of 7.5% of the Applicant. Examples of such an interest include shares in a corporation, partnership interest in a partnership or joint venture, interest of a member or manager in a

Name (indicate whether retained or anticipated to be retained)	Business Address	Relationship to Disclosing Party (subcontractor, attorney, lobbyist, etc.)	Fees (<u>indicate whether paid or estimated.</u>) NOTE: "hourly rate" or "t.b.d." is not an acceptable response.
--	------------------	--	---

(Add sheets if necessary)

Check here if the Disclosing Party has not retained, nor expects to retain, any such persons or entities.

SECTION V -- CERTIFICATIONS

A. COURT-ORDERED CHILD SUPPORT COMPLIANCE

Under MCC Section 2-92-415, substantial owners of business entities that contract with the City must remain in compliance with their child support obligations throughout the contract's term.

Has any person who directly or indirectly owns 10% or more of the Disclosing Party been declared in arrearage on any child support obligations by any Illinois court of competent jurisdiction?

Yes No | No person directly or indirectly owns 10% or more of the Disclosing Party.

If "Yes," has the person entered into a court-approved agreement for payment of all support owed and is the person in compliance with that agreement?

Yes No

B. FURTHER CERTIFICATIONS

1. [This paragraph 1 applies only if the Matter is a contract being handled by the City's Department of Procurement Services.] In the 5-year period preceding the date of this EDS, neither the Disclosing Party nor any Affiliated Entity [see definition in (5) below] has engaged, in connection with the performance of any public contract, the services of an integrity monitor, independent private sector inspector general, or integrity compliance consultant (i.e., an individual or entity with legal, auditing, investigative, or other similar skills, designated by a public agency to help the agency monitor the activity of specified agency vendors as well as help the vendors reform their business practices so they can be considered for agency contracts in the future, or continue with a contract in progress).

2. The Disclosing Party and its Affiliated Entities are not delinquent in the payment of any fine, fee, tax or other source of indebtedness owed to the City of Chicago, including, but not limited to, water and sewer charges, license fees, parking tickets, property taxes and sales taxes, nor is the Disclosing Party delinquent in the payment of any tax administered by the Illinois Department of Revenue.

3. The Disclosing Party and, if the Disclosing Party is a legal entity, all of those persons or entities identified in Section II(B)(1) of this EDS:
- a. are not presently debarred, suspended, proposed for debarment, declared ineligible or voluntarily excluded from any transactions by any federal, state or local unit of government;
 - b. have not, during the 5 years before the date of this EDS, been convicted of a criminal offense, adjudged guilty, or had a civil judgment rendered against them in connection with: obtaining, attempting to obtain, or performing a public (federal, state or local) transaction or contract under a public transaction; a violation of federal or state antitrust statutes; fraud; embezzlement; theft; forgery; bribery; falsification or destruction of records; making false statements; or receiving stolen property;
 - c. are not presently indicted for, or criminally or civilly charged by, a governmental entity (federal, state or local) with committing any of the offenses set forth in subparagraph (b) above;
 - d. have not, during the 5 years before the date of this EDS, had one or more public transactions (federal, state or local) terminated for cause or default; and
 - e. have not, during the 5 years before the date of this EDS, been convicted, adjudged guilty, or found liable in a civil proceeding, or in any criminal or civil action, including actions concerning environmental violations, instituted by the City or by the federal government, any state, or any other unit of local government.
4. The Disclosing Party understands and shall comply with the applicable requirements of MCC Chapters 2-56 (Inspector General) and 2-156 (Governmental Ethics).
5. Certifications (5), (6) and (7) concern:
- the Disclosing Party;
 - any "Contractor" (meaning any contractor or subcontractor used by the Disclosing Party in connection with the Matter, including but not limited to all persons or legal entities disclosed under Section IV, "Disclosure of Subcontractors and Other Retained Parties");
 - any "Affiliated Entity" (meaning a person or entity that, directly or indirectly: controls the Disclosing Party, is controlled by the Disclosing Party, or is, with the Disclosing Party, under common control of another person or entity). Indicia of control include, without limitation: interlocking management or ownership; identity of interests among family members, shared facilities and equipment; common use of employees; or organization of a business entity following the ineligibility of a business entity to do business with federal or state or local government, including the City, using substantially the same management, ownership, or principals as the ineligible entity. With respect to Contractors, the term Affiliated Entity means a person or entity that directly or indirectly controls the Contractor, is controlled by it, or, with the Contractor, is under common control of another person or entity;
 - any responsible official of the Disclosing Party, any Contractor or any Affiliated Entity or any other official, agent or employee of the Disclosing Party, any Contractor or any Affiliated Entity, acting pursuant to the direction or authorization of a responsible official of the Disclosing Party, any Contractor or any Affiliated Entity (collectively "Agents").

Neither the Disclosing Party, nor any Contractor, nor any Affiliated Entity of either the Disclosing Party or any Contractor, nor any Agents have, during the 5 years before the date of this EDS, or, with respect to a Contractor, an Affiliated Entity, or an Affiliated Entity of a Contractor during the 5 years before the date of such Contractor's or Affiliated Entity's contract or engagement in connection with the Matter:

- a. bribed or attempted to bribe, or been convicted or adjudged guilty of bribery or attempting to bribe, a public officer or employee of the City, the State of Illinois, or any agency of the federal government or of any state or local government in the United States of America, in that officer's or employee's official capacity;
 - b. agreed or colluded with other bidders or prospective bidders, or been a party to any such agreement, or been convicted or adjudged guilty of agreement or collusion among bidders or prospective bidders, in restraint of freedom of competition by agreement to bid a fixed price or otherwise; or
 - c. made an admission of such conduct described in subparagraph (a) or (b) above that is a matter of record, but have not been prosecuted for such conduct; or
 - d. violated the provisions referenced in MCC Subsection 2-92-320(a)(4)(Contracts Requiring a Base Wage); (a)(5)(Debarment Regulations); or (a)(6)(Minimum Wage Ordinance).
6. Neither the Disclosing Party, nor any Affiliated Entity or Contractor, or any of their employees, officials, agents or partners, is barred from contracting with any unit of state or local government as a result of engaging in or being convicted of (1) bid-rigging in violation of 720 ILCS 5/33E-3; (2) bid-rotating in violation of 720 ILCS 5/33E-4; or (3) any similar offense of any state or of the United States of America that contains the same elements as the offense of bid-rigging or bid-rotating.
7. Neither the Disclosing Party nor any Affiliated Entity is listed on a Sanctions List maintained by the United States Department of Commerce, State, or Treasury, or any successor federal agency.
8. [FOR APPLICANT ONLY] (i) Neither the Applicant nor any "controlling person" [see MCC Chapter 1-23, Article I for applicability and defined terms] of the Applicant is currently indicted or charged with, or has admitted guilt of, or has ever been convicted of, or placed under supervision for, any criminal offense involving actual, attempted, or conspiracy to commit bribery, theft, fraud, forgery, perjury, dishonesty or deceit against an officer or employee of the City or any "sister agency"; and (ii) the Applicant understands and acknowledges that compliance with Article I is a continuing requirement for doing business with the City. NOTE: If MCC Chapter 1-23, Article I applies to the Applicant, that Article's permanent compliance timeframe supersedes 5-year compliance timeframes in this Section V.
9. [FOR APPLICANT ONLY] The Applicant and its Affiliated Entities will not use, nor permit their subcontractors to use, any facility listed as having an active exclusion by the U.S. EPA on the federal System for Award Management ("SAM").
10. [FOR APPLICANT ONLY] The Applicant will obtain from any contractors/subcontractors hired or to be hired in connection with the Matter certifications equal in form and substance to those in Certifications (2) and (9) above and will not, without the prior written consent of the City, use any such

contractor/subcontractor that does not provide such certifications or that the Applicant has reason to believe has not provided or cannot provide truthful certifications.

11. If the Disclosing Party is unable to certify to any of the above statements in this Part B (Further Certifications), the Disclosing Party must explain below:

N/A

If the letters "NA," the word "None," or no response appears on the lines above, it will be conclusively presumed that the Disclosing Party certified to the above statements.

12. To the best of the Disclosing Party's knowledge after reasonable inquiry, the following is a complete list of all current employees of the Disclosing Party who were, at any time during the 12-month period preceding the date of this EDS, an employee, or elected or appointed official, of the City of Chicago (if none, indicate with "N/A" or "none").

N/A

13. To the best of the Disclosing Party's knowledge after reasonable inquiry, the following is a complete list of all gifts that the Disclosing Party has given or caused to be given, at any time during the 12-month period preceding the execution date of this EDS, to an employee, or elected or appointed official, of the City of Chicago. For purposes of this statement, a "gift" does not include: (i) anything made generally available to City employees or to the general public, or (ii) food or drink provided in the course of official City business and having a retail value of less than \$25 per recipient, or (iii) a political contribution otherwise duly reported as required by law (if none, indicate with "N/A" or "none"). As to any gift listed below, please also list the name of the City recipient.

N/A

C. CERTIFICATION OF STATUS AS FINANCIAL INSTITUTION

1. The Disclosing Party certifies that the Disclosing Party (check one)

is is not

a "financial institution" as defined in MCC Section 2-32-455(b).

2. If the Disclosing Party IS a financial institution, then the Disclosing Party pledges:

"We are not and will not become a predatory lender as defined in MCC Chapter 2-32. We further pledge that none of our affiliates is, and none of them will become, a predatory lender as defined in MCC Chapter 2-32. We understand that becoming a predatory lender or becoming an affiliate of a predatory lender may result in the loss of the privilege of doing business with the City."

If the Disclosing Party is unable to make this pledge because it or any of its affiliates (as defined in MCC Section 2-32-455(b)) is a predatory lender within the meaning of MCC Chapter 2-32, explain here (attach additional pages if necessary):

N/A

If the letters "NA," the word "None," or no response appears on the lines above, it will be conclusively presumed that the Disclosing Party certified to the above statements.

D. CERTIFICATION REGARDING FINANCIAL INTEREST IN CITY BUSINESS

Any words or terms defined in MCC Chapter 2-156 have the same meanings if used in this Part D.

1. In accordance with MCC Section 2-156-110: To the best of the Disclosing Party's knowledge after reasonable inquiry, does any official or employee of the City have a financial interest in his or her own name or in the name of any other person or entity in the Matter?

Yes No

NOTE: If you checked "Yes" to Item D(1), proceed to Items D(2) and D(3). If you checked "No" to Item D(1), skip Items D(2) and D(3) and proceed to Part E.

2. Unless sold pursuant to a process of competitive bidding, or otherwise permitted, no City elected official or employee shall have a financial interest in his or her own name or in the name of any other person or entity in the purchase of any property that (i) belongs to the City, or (ii) is sold for taxes or assessments, or (iii) is sold by virtue of legal process at the suit of the City (collectively, "City Property Sale"). Compensation for property taken pursuant to the City's eminent domain power does not constitute a financial interest within the meaning of this Part D.

Does the Matter involve a City Property Sale?

Yes No

3. If you checked "Yes" to Item D(1), provide the names and business addresses of the City officials or employees having such financial interest and identify the nature of the financial interest:

Name	Business Address	Nature of Financial Interest
<hr/>		
<hr/>		
<hr/>		

4. The Disclosing Party further certifies that no prohibited financial interest in the Matter will be acquired by any City official or employee.

E. CERTIFICATION REGARDING SLAVERY ERA BUSINESS

Please check either (1) or (2) below. If the Disclosing Party checks (2), the Disclosing Party must disclose below or in an attachment to this EDS all information required by (2). Failure to comply with these disclosure requirements may make any contract entered into with the City in connection with the Matter voidable by the City.

X 1. The Disclosing Party verifies that the Disclosing Party has searched any and all records of the Disclosing Party and any and all predecessor entities regarding records of investments or profits from slavery or slaveholder insurance policies during the slavery era (including insurance policies issued to slaveholders that provided coverage for damage to or injury or death of their slaves), and the Disclosing Party has found no such records.

2. The Disclosing Party verifies that, as a result of conducting the search in step (1) above, the Disclosing Party has found records of investments or profits from slavery or slaveholder insurance policies. The Disclosing Party verifies that the following constitutes full disclosure of all such records, including the names of any and all slaves or slaveholders described in those records:

SECTION VI -- CERTIFICATIONS FOR FEDERALLY FUNDED MATTERS

NOTE: If the Matter is federally funded, complete this Section VI. If the Matter is not federally funded, proceed to Section VII. For purposes of this Section VI, tax credits allocated by the City and proceeds of debt obligations of the City are not federal funding.

A. CERTIFICATION REGARDING LOBBYING

1. List below the names of all persons or entities registered under the federal Lobbying Disclosure Act of 1995, as amended, who have made lobbying contacts on behalf of the Disclosing Party with respect to the Matter: (Add sheets if necessary):

(If no explanation appears or begins on the lines above, or if the letters "NA" or if the word "None" appear, it will be conclusively presumed that the Disclosing Party means that NO persons or entities registered under the Lobbying Disclosure Act of 1995, as amended, have made lobbying contacts on behalf of the Disclosing Party with respect to the Matter.)

2. The Disclosing Party has not spent and will not expend any federally appropriated funds to pay any person or entity listed in paragraph A(1) above for his or her lobbying activities or to pay any person or entity to influence or attempt to influence an officer or employee of any agency, as defined by applicable federal law, a member of Congress, an officer or employee of Congress, or an employee

of a member of Congress, in connection with the award of any federally funded contract, making any federally funded grant or loan, entering into any cooperative agreement, or to extend, continue, renew, amend, or modify any federally funded contract, grant, loan, or cooperative agreement.

3. The Disclosing Party will submit an updated certification at the end of each calendar quarter in which there occurs any event that materially affects the accuracy of the statements and information set forth in paragraphs A(1) and A(2) above.

4. The Disclosing Party certifies that either: (i) it is not an organization described in section 501(c)(4) of the Internal Revenue Code of 1986; or (ii) it is an organization described in section 501(c)(4) of the Internal Revenue Code of 1986 but has not engaged and will not engage in "Lobbying Activities," as that term is defined in the Lobbying Disclosure Act of 1995, as amended.

5. If the Disclosing Party is the Applicant, the Disclosing Party must obtain certifications equal in form and substance to paragraphs A(1) through A(4) above from all subcontractors before it awards any subcontract and the Disclosing Party must maintain all such subcontractors' certifications for the duration of the Matter and must make such certifications promptly available to the City upon request.

B. CERTIFICATION REGARDING EQUAL EMPLOYMENT OPPORTUNITY

If the Matter is federally funded, federal regulations require the Applicant and all proposed subcontractors to submit the following information with their bids or in writing at the outset of negotiations.

Is the Disclosing Party the Applicant?

Yes

No

If "Yes," answer the three questions below:

1. Have you developed and do you have on file affirmative action programs pursuant to applicable federal regulations? (See 41 CFR Part 60-2.)

Yes

No

2. Have you filed with the Joint Reporting Committee, the Director of the Office of Federal Contract Compliance Programs, or the Equal Employment Opportunity Commission all reports due under the applicable filing requirements?

Yes

No

Reports not required

3. Have you participated in any previous contracts or subcontracts subject to the equal opportunity clause?

Yes

No

If you checked "No" to question (1) or (2) above, please provide an explanation:

SECTION VII -- FURTHER ACKNOWLEDGMENTS AND CERTIFICATION

The Disclosing Party understands and agrees that:

A. The certifications, disclosures, and acknowledgments contained in this EDS will become part of any contract or other agreement between the Applicant and the City in connection with the Matter, whether procurement, City assistance, or other City action, and are material inducements to the City's execution of any contract or taking other action with respect to the Matter. The Disclosing Party understands that it must comply with all statutes, ordinances, and regulations on which this EDS is based.

B. The City's Governmental Ethics Ordinance, MCC Chapter 2-156, imposes certain duties and obligations on persons or entities seeking City contracts, work, business, or transactions. The full text of this ordinance and a training program is available on line at www.cityofchicago.org/Ethics, and may also be obtained from the City's Board of Ethics, 740 N. Sedgwick St., Suite 500, Chicago, IL 60610, (312) 744-9660. The Disclosing Party must comply fully with this ordinance.

C. If the City determines that any information provided in this EDS is false, incomplete or inaccurate, any contract or other agreement in connection with which it is submitted may be rescinded or be void or voidable, and the City may pursue any remedies under the contract or agreement (if not rescinded or void), at law, or in equity, including terminating the Disclosing Party's participation in the Matter and/or declining to allow the Disclosing Party to participate in other City transactions. Remedies at law for a false statement of material fact may include incarceration and an award to the City of treble damages.

D. It is the City's policy to make this document available to the public on its Internet site and/or upon request. Some or all of the information provided in, and appended to, this EDS may be made publicly available on the Internet, in response to a Freedom of Information Act request, or otherwise. By completing and signing this EDS, the Disclosing Party waives and releases any possible rights or claims which it may have against the City in connection with the public release of information contained in this EDS and also authorizes the City to verify the accuracy of any information submitted in this EDS.

E. The information provided in this EDS must be kept current. In the event of changes, the Disclosing Party must supplement this EDS up to the time the City takes action on the Matter. If the Matter is a contract being handled by the City's Department of Procurement Services, the Disclosing Party must update this EDS as the contract requires. **NOTE:** With respect to Matters subject to MCC Chapter 1-23, Article I (imposing **PERMANENT INELIGIBILITY** for certain specified offenses), the information provided herein regarding eligibility must be kept current for a longer period, as required by MCC Chapter 1-23 and Section 2-154-020.

CERTIFICATION

Under penalty of perjury, the person signing below: (1) warrants that he/she is authorized to execute this EDS, and all applicable Appendices, on behalf of the Disclosing Party, and (2) warrants that all certifications and statements contained in this EDS, and all applicable Appendices, are true, accurate and complete as of the date furnished to the City.

Wanxiang America Corporation

(Print or type exact legal name of Disclosing Party)

By: *Pin Ni*
(Sign here)

Pin Ni
(Print or type name of person signing)

Authorized Signatory
(Print or type title of person signing)

Signed and sworn to before me on (date) 2/26/19.

at Cook County, Illinois (state).

Raquel E. Cortes
Notary Public



Commission expires: 4/30/22

1944
MAY 10 1944
U.S. DEPARTMENT OF AGRICULTURE
WASHINGTON, D. C.
OFFICE OF THE ASSISTANT SECRETARY
FOR TECHNICAL ASSISTANCE
AND COOPERATION

**CITY OF CHICAGO
ECONOMIC DISCLOSURE STATEMENT AND AFFIDAVIT
APPENDIX A**

**FAMILIAL RELATIONSHIPS WITH ELECTED CITY OFFICIALS
AND DEPARTMENT HEADS**

This Appendix is to be completed only by (a) the Applicant, and (b) any legal entity which has a direct ownership interest in the Applicant exceeding 7.5%. It is not to be completed by any legal entity which has only an indirect ownership interest in the Applicant.

Under MCC Section 2-154-015, the Disclosing Party must disclose whether such Disclosing Party or any "Applicable Party" or any Spouse or Domestic Partner thereof currently has a "familial relationship" with any elected city official or department head. A "familial relationship" exists if, as of the date this EDS is signed, the Disclosing Party or any "Applicable Party" or any Spouse or Domestic Partner thereof is related to the mayor, any alderman, the city clerk, the city treasurer or any city department head as spouse or domestic partner or as any of the following, whether by blood or adoption: parent, child, brother or sister, aunt or uncle, niece or nephew, grandparent, grandchild, father-in-law, mother-in-law, son-in-law, daughter-in-law, stepfather or stepmother, stepson or stepdaughter, stepbrother or stepsister or half-brother or half-sister.

"Applicable Party" means (1) all executive officers of the Disclosing Party listed in Section II.B.1.a., if the Disclosing Party is a corporation; all partners of the Disclosing Party, if the Disclosing Party is a general partnership; all general partners and limited partners of the Disclosing Party, if the Disclosing Party is a limited partnership; all managers, managing members and members of the Disclosing Party, if the Disclosing Party is a limited liability company; (2) all principal officers of the Disclosing Party; and (3) any person having more than a 7.5% ownership interest in the Disclosing Party. "Principal officers" means the president, chief operating officer, executive director, chief financial officer, treasurer or secretary of a legal entity or any person exercising similar authority.

Does the Disclosing Party or any "Applicable Party" or any Spouse or Domestic Partner thereof currently have a "familial relationship" with an elected city official or department head?

Yes No

If yes, please identify below (1) the name and title of such person, (2) the name of the legal entity to which such person is connected; (3) the name and title of the elected city official or department head to whom such person has a familial relationship, and (4) the precise nature of such familial relationship.

**CITY OF CHICAGO
ECONOMIC DISCLOSURE STATEMENT AND AFFIDAVIT
APPENDIX B**

BUILDING CODE SCOFFLAW/PROBLEM LANDLORD CERTIFICATION

This Appendix is to be completed only by (a) the Applicant, and (b) any legal entity which has a direct ownership interest in the Applicant exceeding 7.5% (an "Owner"). It is not to be completed by any legal entity which has only an indirect ownership interest in the Applicant.

1. Pursuant to MCC Section 2-154-010, is the Applicant or any Owner identified as a building code scofflaw or problem landlord pursuant to MCC Section 2-92-416?

Yes No

2. If the Applicant is a legal entity publicly traded on any exchange, is any officer or director of the Applicant identified as a building code scofflaw or problem landlord pursuant to MCC Section 2-92-416?

Yes No The Applicant is not publicly traded on any exchange.

3. If yes to (1) or (2) above, please identify below the name of each person or legal entity identified as a building code scofflaw or problem landlord and the address of each building or buildings to which the pertinent code violations apply.

**CITY OF CHICAGO
ECONOMIC DISCLOSURE STATEMENT AND AFFIDAVIT
APPENDIX C**

PROHIBITION ON WAGE & SALARY HISTORY SCREENING - CERTIFICATION

This Appendix is to be completed only by an Applicant that is completing this EDS as a “contractor” as defined in MCC Section 2-92-385. That section, which should be consulted (www.amlegal.com), generally covers a party to any agreement pursuant to which they: (i) receive City of Chicago funds in consideration for services, work or goods provided (including for legal or other professional services), or (ii) pay the City money for a license, grant or concession allowing them to conduct a business on City premises.

On behalf of an Applicant that is a contractor pursuant to MCC Section 2-92-385, I hereby certify that the Applicant is in compliance with MCC Section 2-92-385(b)(1) and (2), which prohibit: (i) screening job applicants based on their wage or salary history, or (ii) seeking job applicants’ wage or salary history from current or former employers. I also certify that the Applicant has adopted a policy that includes those prohibitions.

Yes

No

N/A – I am not an Applicant that is a “contractor” as defined in MCC Section 2-92-385.

This certification shall serve as the affidavit required by MCC Section 2-92-385(c)(1).

If you checked “no” to the above, please explain.

**CITY OF CHICAGO
ECONOMIC DISCLOSURE STATEMENT
AND AFFIDAVIT**

SECTION I -- GENERAL INFORMATION

A. Legal name of the Disclosing Party submitting this EDS. Include d/b/a/ if applicable:

Wanxiang Group Corporation (a PRC Collective-Owned Enterprise)

Check ONE of the following three boxes:

Indicate whether the Disclosing Party submitting this EDS is:

1. the Applicant

OR

2. a legal entity currently holding, or anticipated to hold within six months after City action on the contract, transaction or other undertaking to which this EDS pertains (referred to below as the "Matter"), a direct or indirect interest in excess of 7.5% in the Applicant. State the Applicant's legal name: 345 N. Morgan, LLC

OR

3. a legal entity with a direct or indirect right of control of the Applicant (see Section II(B)(1))
State the legal name of the entity in which the Disclosing Party holds a right of control:

B. Business address of the Disclosing Party: Xiaoshan Economic and Technological Development Zone,

Hanzhou, Zhejiang Province, The People's Republic of China

C. Telephone: 847-921-7064 Fax: 847-931-4339 Email: lkrueger@wanxiang.com

D. Name of contact person: Lawrence J. Krueger

E. Federal Employer Identification No. (if you have one): _____

F. Brief description of the Matter to which this EDS pertains. (Include project number and location of property, if applicable):

Application for planned development for property commonly known as 345 N. Morgan St., 311 N. Morgan St., and 1000 W. Carroll, Chicago, IL

G. Which City agency or department is requesting this EDS? DPD

If the Matter is a contract being handled by the City's Department of Procurement Services, please complete the following:

Specification # N/A and Contract # N/A

SECTION II -- DISCLOSURE OF OWNERSHIP INTERESTS

A. NATURE OF THE DISCLOSING PARTY

1. Indicate the nature of the Disclosing Party:

- | | |
|---|--|
| <input type="checkbox"/> Person | <input type="checkbox"/> Limited liability company |
| <input type="checkbox"/> Publicly registered business corporation | <input type="checkbox"/> Limited liability partnership |
| <input type="checkbox"/> Privately held business corporation | <input type="checkbox"/> Joint venture |
| <input type="checkbox"/> Sole proprietorship | <input type="checkbox"/> Not-for-profit corporation |
| <input type="checkbox"/> General partnership | (Is the not-for-profit corporation also a 501(c)(3))? |
| <input type="checkbox"/> Limited partnership | <input type="checkbox"/> Yes <input type="checkbox"/> No |
| <input type="checkbox"/> Trust | <input checked="" type="checkbox"/> Other (please specify) |
- Collective-Owned Enterprise of the People's Republic of China

2. For legal entities, the state (or foreign country) of incorporation or organization, if applicable:

People's Republic of China

3. For legal entities not organized in the State of Illinois: Has the organization registered to do business in the State of Illinois as a foreign entity?

- Yes No Organized in Illinois

B. IF THE DISCLOSING PARTY IS A LEGAL ENTITY:

1. List below the full names and titles, if applicable, of: (i) all executive officers and all directors of the entity; (ii) **for not-for-profit corporations**, all members, if any, which are legal entities (if there are no such members, write "no members which are legal entities"); (iii) **for trusts, estates or other similar entities**, the trustee, executor, administrator, or similarly situated party; (iv) **for general or limited partnerships, limited liability companies, limited liability partnerships or joint ventures**, each general partner, managing member, manager or any other person or legal entity that directly or indirectly controls the day-to-day management of the Applicant.

NOTE: Each legal entity listed below must submit an EDS on its own behalf.

Name	Title
Weiding Lu	Chairman
Pin Ni	Director

2. Please provide the following information concerning each person or legal entity having a direct or indirect, current or prospective (i.e. within 6 months after City action) beneficial interest (including ownership) in excess of 7.5% of the Applicant. Examples of such an interest include shares in a corporation, partnership interest in a partnership or joint venture, interest of a member or manager in a

Name (indicate whether retained or anticipated to be retained)	Business Address	Relationship to Disclosing Party (subcontractor, attorney, lobbyist, etc.)	Fees (<u>indicate whether paid or estimated.</u>) NOTE: "hourly rate" or "t.b.d." is not an acceptable response.
--	------------------	--	--

(Add sheets if necessary)

Check here if the Disclosing Party has not retained, nor expects to retain, any such persons or entities.

SECTION V -- CERTIFICATIONS

A. COURT-ORDERED CHILD SUPPORT COMPLIANCE

Under MCC Section 2-92-415, substantial owners of business entities that contract with the City must remain in compliance with their child support obligations throughout the contract's term.

Has any person who directly or indirectly owns 10% or more of the Disclosing Party been declared in arrearage on any child support obligations by any Illinois court of competent jurisdiction?

Yes No No person directly or indirectly owns 10% or more of the Disclosing Party.

If "Yes," has the person entered into a court-approved agreement for payment of all support owed and is the person in compliance with that agreement?

Yes No

B. FURTHER CERTIFICATIONS

1. [This paragraph 1 applies only if the Matter is a contract being handled by the City's Department of Procurement Services.] In the 5-year period preceding the date of this EDS, neither the Disclosing Party nor any Affiliated Entity [see definition in (5) below] has engaged, in connection with the performance of any public contract, the services of an integrity monitor, independent private sector inspector general, or integrity compliance consultant (i.e., an individual or entity with legal, auditing, investigative, or other similar skills, designated by a public agency to help the agency monitor the activity of specified agency vendors as well as help the vendors reform their business practices so they can be considered for agency contracts in the future, or continue with a contract in progress).

2. The Disclosing Party and its Affiliated Entities are not delinquent in the payment of any fine, fee, tax or other source of indebtedness owed to the City of Chicago, including, but not limited to, water and sewer charges, license fees, parking tickets, property taxes and sales taxes, nor is the Disclosing Party delinquent in the payment of any tax administered by the Illinois Department of Revenue.

3. The Disclosing Party and, if the Disclosing Party is a legal entity, all of those persons or entities identified in Section II(B)(1) of this EDS:
- a. are not presently debarred, suspended, proposed for debarment, declared ineligible or voluntarily excluded from any transactions by any federal, state or local unit of government;
 - b. have not, during the 5 years before the date of this EDS, been convicted of a criminal offense, adjudged guilty, or had a civil judgment rendered against them in connection with: obtaining, attempting to obtain, or performing a public (federal, state or local) transaction or contract under a public transaction; a violation of federal or state antitrust statutes; fraud; embezzlement; theft; forgery; bribery; falsification or destruction of records; making false statements; or receiving stolen property;
 - c. are not presently indicted for, or criminally or civilly charged by, a governmental entity (federal, state or local) with committing any of the offenses set forth in subparagraph (b) above;
 - d. have not, during the 5 years before the date of this EDS, had one or more public transactions (federal, state or local) terminated for cause or default; and
 - e. have not, during the 5 years before the date of this EDS, been convicted, adjudged guilty, or found liable in a civil proceeding, or in any criminal or civil action, including actions concerning environmental violations, instituted by the City or by the federal government, any state, or any other unit of local government.
4. The Disclosing Party understands and shall comply with the applicable requirements of MCC Chapters 2-56 (Inspector General) and 2-156 (Governmental Ethics).
5. Certifications (5), (6) and (7) concern:
- the Disclosing Party;
 - any "Contractor" (meaning any contractor or subcontractor used by the Disclosing Party in connection with the Matter, including but not limited to all persons or legal entities disclosed under Section IV, "Disclosure of Subcontractors and Other Retained Parties");
 - any "Affiliated Entity" (meaning a person or entity that, directly or indirectly: controls the Disclosing Party, is controlled by the Disclosing Party, or is, with the Disclosing Party, under common control of another person or entity). Indicia of control include, without limitation: interlocking management or ownership; identity of interests among family members, shared facilities and equipment; common use of employees; or organization of a business entity following the ineligibility of a business entity to do business with federal or state or local government, including the City, using substantially the same management, ownership, or principals as the ineligible entity. With respect to Contractors, the term Affiliated Entity means a person or entity that directly or indirectly controls the Contractor, is controlled by it, or, with the Contractor, is under common control of another person or entity;
 - any responsible official of the Disclosing Party, any Contractor or any Affiliated Entity or any other official, agent or employee of the Disclosing Party, any Contractor or any Affiliated Entity, acting pursuant to the direction or authorization of a responsible official of the Disclosing Party, any Contractor or any Affiliated Entity (collectively "Agents").

Neither the Disclosing Party, nor any Contractor, nor any Affiliated Entity of either the Disclosing Party or any Contractor, nor any Agents have, during the 5 years before the date of this EDS, or, with respect to a Contractor, an Affiliated Entity, or an Affiliated Entity of a Contractor during the 5 years before the date of such Contractor's or Affiliated Entity's contract or engagement in connection with the Matter:

- a. bribed or attempted to bribe, or been convicted or adjudged guilty of bribery or attempting to bribe, a public officer or employee of the City, the State of Illinois, or any agency of the federal government or of any state or local government in the United States of America, in that officer's or employee's official capacity;
- b. agreed or colluded with other bidders or prospective bidders, or been a party to any such agreement, or been convicted or adjudged guilty of agreement or collusion among bidders or prospective bidders, in restraint of freedom of competition by agreement to bid a fixed price or otherwise; or
- c. made an admission of such conduct described in subparagraph (a) or (b) above that is a matter of record, but have not been prosecuted for such conduct; or
- d. violated the provisions referenced in MCC Subsection 2-92-320(a)(4)(Contracts Requiring a Base Wage); (a)(5)(Debarment Regulations); or (a)(6)(Minimum Wage Ordinance).

6. Neither the Disclosing Party, nor any Affiliated Entity or Contractor, or any of their employees, officials, agents or partners, is barred from contracting with any unit of state or local government as a result of engaging in or being convicted of (1) bid-rigging in violation of 720 ILCS 5/33E-3; (2) bid-rotating in violation of 720 ILCS 5/33E-4; or (3) any similar offense of any state or of the United States of America that contains the same elements as the offense of bid-rigging or bid-rotating.

7. Neither the Disclosing Party nor any Affiliated Entity is listed on a Sanctions List maintained by the United States Department of Commerce, State, or Treasury, or any successor federal agency.

8. [FOR APPLICANT ONLY] (i) Neither the Applicant nor any "controlling person" [see MCC Chapter 1-23, Article I for applicability and defined terms] of the Applicant is currently indicted or charged with, or has admitted guilt of, or has ever been convicted of, or placed under supervision for, any criminal offense involving actual, attempted, or conspiracy to commit bribery, theft, fraud, forgery, perjury, dishonesty or deceit against an officer or employee of the City or any "sister agency"; and (ii) the Applicant understands and acknowledges that compliance with Article I is a continuing requirement for doing business with the City. NOTE: If MCC Chapter 1-23, Article I applies to the Applicant, that Article's permanent compliance timeframe supersedes 5-year compliance timeframes in this Section V.

9. [FOR APPLICANT ONLY] The Applicant and its Affiliated Entities will not use, nor permit their subcontractors to use, any facility listed as having an active exclusion by the U.S. EPA on the federal System for Award Management ("SAM").

10. [FOR APPLICANT ONLY] The Applicant will obtain from any contractors/subcontractors hired or to be hired in connection with the Matter certifications equal in form and substance to those in Certifications (2) and (9) above and will not, without the prior written consent of the City, use any such

contractor/subcontractor that does not provide such certifications or that the Applicant has reason to believe has not provided or cannot provide truthful certifications.

11. If the Disclosing Party is unable to certify to any of the above statements in this Part B (Further Certifications), the Disclosing Party must explain below:

N/A

If the letters "NA," the word "None," or no response appears on the lines above, it will be conclusively presumed that the Disclosing Party certified to the above statements.

12. To the best of the Disclosing Party's knowledge after reasonable inquiry, the following is a complete list of all current employees of the Disclosing Party who were, at any time during the 12-month period preceding the date of this EDS, an employee, or elected or appointed official, of the City of Chicago (if none, indicate with "N/A" or "none").

N/A

13. To the best of the Disclosing Party's knowledge after reasonable inquiry, the following is a complete list of all gifts that the Disclosing Party has given or caused to be given, at any time during the 12-month period preceding the execution date of this EDS, to an employee, or elected or appointed official, of the City of Chicago. For purposes of this statement, a "gift" does not include: (i) anything made generally available to City employees or to the general public, or (ii) food or drink provided in the course of official City business and having a retail value of less than \$25 per recipient, or (iii) a political contribution otherwise duly reported as required by law (if none, indicate with "N/A" or "none"). As to any gift listed below, please also list the name of the City recipient.

N/A

C. CERTIFICATION OF STATUS AS FINANCIAL INSTITUTION

1. The Disclosing Party certifies that the Disclosing Party (check one)

is is not

a "financial institution" as defined in MCC Section 2-32-455(b).

2. If the Disclosing Party IS a financial institution, then the Disclosing Party pledges:

"We are not and will not become a predatory lender as defined in MCC Chapter 2-32. We further pledge that none of our affiliates is, and none of them will become, a predatory lender as defined in MCC Chapter 2-32. We understand that becoming a predatory lender or becoming an affiliate of a predatory lender may result in the loss of the privilege of doing business with the City."

If the Disclosing Party is unable to make this pledge because it or any of its affiliates (as defined in MCC Section 2-32-455(b)) is a predatory lender within the meaning of MCC Chapter 2-32, explain here (attach additional pages if necessary):

N/A

If the letters "NA," the word "None," or no response appears on the lines above, it will be conclusively presumed that the Disclosing Party certified to the above statements.

D. CERTIFICATION REGARDING FINANCIAL INTEREST IN CITY BUSINESS

Any words or terms defined in MCC Chapter 2-156 have the same meanings if used in this Part D.

1. In accordance with MCC Section 2-156-110: To the best of the Disclosing Party's knowledge after reasonable inquiry, does any official or employee of the City have a financial interest in his or her own name or in the name of any other person or entity in the Matter?

Yes No

NOTE: If you checked "Yes" to Item D(1), proceed to Items D(2) and D(3). If you checked "No" to Item D(1), skip Items D(2) and D(3) and proceed to Part E.

2. Unless sold pursuant to a process of competitive bidding, or otherwise permitted, no City elected official or employee shall have a financial interest in his or her own name or in the name of any other person or entity in the purchase of any property that (i) belongs to the City, or (ii) is sold for taxes or assessments, or (iii) is sold by virtue of legal process at the suit of the City (collectively, "City Property Sale"). Compensation for property taken pursuant to the City's eminent domain power does not constitute a financial interest within the meaning of this Part D.

Does the Matter involve a City Property Sale?

Yes No

3. If you checked "Yes" to Item D(1), provide the names and business addresses of the City officials or employees having such financial interest and identify the nature of the financial interest:

Name	Business Address	Nature of Financial Interest
<hr/>		
<hr/>		
<hr/>		

4. The Disclosing Party further certifies that no prohibited financial interest in the Matter will be acquired by any City official or employee.

E. CERTIFICATION REGARDING SLAVERY ERA BUSINESS

Please check either (1) or (2) below. If the Disclosing Party checks (2), the Disclosing Party must disclose below or in an attachment to this EDS all information required by (2). Failure to comply with these disclosure requirements may make any contract entered into with the City in connection with the Matter voidable by the City.

X 1. The Disclosing Party verifies that the Disclosing Party has searched any and all records of the Disclosing Party and any and all predecessor entities regarding records of investments or profits from slavery or slaveholder insurance policies during the slavery era (including insurance policies issued to slaveholders that provided coverage for damage to or injury or death of their slaves), and the Disclosing Party has found no such records.

___ 2. The Disclosing Party verifies that, as a result of conducting the search in step (1) above, the Disclosing Party has found records of investments or profits from slavery or slaveholder insurance policies. The Disclosing Party verifies that the following constitutes full disclosure of all such records, including the names of any and all slaves or slaveholders described in those records:

SECTION VI -- CERTIFICATIONS FOR FEDERALLY FUNDED MATTERS

NOTE: If the Matter is federally funded, complete this Section VI. If the Matter is not federally funded, proceed to Section VII. For purposes of this Section VI, tax credits allocated by the City and proceeds of debt obligations of the City are not federal funding.

A. CERTIFICATION REGARDING LOBBYING

1. List below the names of all persons or entities registered under the federal Lobbying Disclosure Act of 1995, as amended, who have made lobbying contacts on behalf of the Disclosing Party with respect to the Matter: (Add sheets if necessary):

(If no explanation appears or begins on the lines above, or if the letters "NA" or if the word "None" appear, it will be conclusively presumed that the Disclosing Party means that NO persons or entities registered under the Lobbying Disclosure Act of 1995, as amended, have made lobbying contacts on behalf of the Disclosing Party with respect to the Matter.)

2. The Disclosing Party has not spent and will not expend any federally appropriated funds to pay any person or entity listed in paragraph A(1) above for his or her lobbying activities or to pay any person or entity to influence or attempt to influence an officer or employee of any agency, as defined by applicable federal law, a member of Congress, an officer or employee of Congress, or an employee

of a member of Congress, in connection with the award of any federally funded contract, making any federally funded grant or loan, entering into any cooperative agreement, or to extend, continue, renew, amend, or modify any federally funded contract, grant, loan, or cooperative agreement.

3. The Disclosing Party will submit an updated certification at the end of each calendar quarter in which there occurs any event that materially affects the accuracy of the statements and information set forth in paragraphs A(1) and A(2) above.

4. The Disclosing Party certifies that either: (i) it is not an organization described in section 501(c)(4) of the Internal Revenue Code of 1986; or (ii) it is an organization described in section 501(c)(4) of the Internal Revenue Code of 1986 but has not engaged and will not engage in "Lobbying Activities," as that term is defined in the Lobbying Disclosure Act of 1995, as amended.

5. If the Disclosing Party is the Applicant, the Disclosing Party must obtain certifications equal in form and substance to paragraphs A(1) through A(4) above from all subcontractors before it awards any subcontract and the Disclosing Party must maintain all such subcontractors' certifications for the duration of the Matter and must make such certifications promptly available to the City upon request.

B. CERTIFICATION REGARDING EQUAL EMPLOYMENT OPPORTUNITY

If the Matter is federally funded, federal regulations require the Applicant and all proposed subcontractors to submit the following information with their bids or in writing at the outset of negotiations.

Is the Disclosing Party the Applicant?

Yes No

If "Yes," answer the three questions below:

1. Have you developed and do you have on file affirmative action programs pursuant to applicable federal regulations? (See 41 CFR Part 60-2.)

Yes No

2. Have you filed with the Joint Reporting Committee, the Director of the Office of Federal Contract Compliance Programs, or the Equal Employment Opportunity Commission all reports due under the applicable filing requirements?

Yes No Reports not required

3. Have you participated in any previous contracts or subcontracts subject to the equal opportunity clause?

Yes No

If you checked "No" to question (1) or (2) above, please provide an explanation:

SECTION VII -- FURTHER ACKNOWLEDGMENTS AND CERTIFICATION

The Disclosing Party understands and agrees that:

A. The certifications, disclosures, and acknowledgments contained in this EDS will become part of any contract or other agreement between the Applicant and the City in connection with the Matter, whether procurement, City assistance, or other City action, and are material inducements to the City's execution of any contract or taking other action with respect to the Matter. The Disclosing Party understands that it must comply with all statutes, ordinances, and regulations on which this EDS is based.

B. The City's Governmental Ethics Ordinance, MCC Chapter 2-156, imposes certain duties and obligations on persons or entities seeking City contracts, work, business, or transactions. The full text of this ordinance and a training program is available on line at www.cityofchicago.org/Ethics, and may also be obtained from the City's Board of Ethics, 740 N. Sedgwick St., Suite 500, Chicago, IL 60610, (312) 744-9660. The Disclosing Party must comply fully with this ordinance.

C. If the City determines that any information provided in this EDS is false, incomplete or inaccurate, any contract or other agreement in connection with which it is submitted may be rescinded or be void or voidable, and the City may pursue any remedies under the contract or agreement (if not rescinded or void), at law, or in equity, including terminating the Disclosing Party's participation in the Matter and/or declining to allow the Disclosing Party to participate in other City transactions. Remedies at law for a false statement of material fact may include incarceration and an award to the City of treble damages.

D. It is the City's policy to make this document available to the public on its Internet site and/or upon request. Some or all of the information provided in, and appended to, this EDS may be made publicly available on the Internet, in response to a Freedom of Information Act request, or otherwise. By completing and signing this EDS, the Disclosing Party waives and releases any possible rights or claims which it may have against the City in connection with the public release of information contained in this EDS and also authorizes the City to verify the accuracy of any information submitted in this EDS.

E. The information provided in this EDS must be kept current. In the event of changes, the Disclosing Party must supplement this EDS up to the time the City takes action on the Matter. If the Matter is a contract being handled by the City's Department of Procurement Services, the Disclosing Party must update this EDS as the contract requires. **NOTE:** With respect to Matters subject to MCC Chapter 1-23, Article I (imposing **PERMANENT INELIGIBILITY** for certain specified offenses), the information provided herein regarding eligibility must be kept current for a longer period, as required by MCC Chapter 1-23 and Section 2-154-020.

CERTIFICATION

Under penalty of perjury, the person signing below: (1) warrants that he/she is authorized to execute this EDS, and all applicable Appendices, on behalf of the Disclosing Party, and (2) warrants that all certifications and statements contained in this EDS, and all applicable Appendices, are true, accurate and complete as of the date furnished to the City.

Wanxiang Group Corporation (a PRC Collective-Owned Enterprise)

(Print or type exact legal name of Disclosing Party)

By: Pin Ni
(Sign here)

Pin Ni
(Print or type name of person signing)

Authorized Signatory
(Print or type title of person signing)

Signed and sworn to before me on (date) 2/26/19,

at Cook County, Illinois (state).

Raquel E. Cortes
Notary Public



Commission expires: 4/30/22

NOTARY PUBLIC - STATE OF ILLINOIS
MY COMMISSION EXPIRES ON
JULY 1, 2012

**CITY OF CHICAGO
ECONOMIC DISCLOSURE STATEMENT AND AFFIDAVIT
APPENDIX A**

**FAMILIAL RELATIONSHIPS WITH ELECTED CITY OFFICIALS
AND DEPARTMENT HEADS**

This Appendix is to be completed only by (a) the Applicant, and (b) any legal entity which has a direct ownership interest in the Applicant exceeding 7.5%. It is not to be completed by any legal entity which has only an indirect ownership interest in the Applicant.

Under MCC Section 2-154-015, the Disclosing Party must disclose whether such Disclosing Party or any "Applicable Party" or any Spouse or Domestic Partner thereof currently has a "familial relationship" with any elected city official or department head. A "familial relationship" exists if, as of the date this EDS is signed, the Disclosing Party or any "Applicable Party" or any Spouse or Domestic Partner thereof is related to the mayor, any alderman, the city clerk, the city treasurer or any city department head as spouse or domestic partner or as any of the following, whether by blood or adoption: parent, child, brother or sister, aunt or uncle, niece or nephew, grandparent, grandchild, father-in-law, mother-in-law, son-in-law, daughter-in-law, stepfather or stepmother, stepson or stepdaughter, stepbrother or stepsister or half-brother or half-sister.

"Applicable Party" means (1) all executive officers of the Disclosing Party listed in Section II.B.1.a., if the Disclosing Party is a corporation; all partners of the Disclosing Party, if the Disclosing Party is a general partnership; all general partners and limited partners of the Disclosing Party, if the Disclosing Party is a limited partnership; all managers, managing members and members of the Disclosing Party, if the Disclosing Party is a limited liability company; (2) all principal officers of the Disclosing Party; and (3) any person having more than a 7.5% ownership interest in the Disclosing Party. "Principal officers" means the president, chief operating officer, executive director, chief financial officer, treasurer or secretary of a legal entity or any person exercising similar authority.

Does the Disclosing Party or any "Applicable Party" or any Spouse or Domestic Partner thereof currently have a "familial relationship" with an elected city official or department head?

Yes

No

If yes, please identify below (1) the name and title of such person, (2) the name of the legal entity to which such person is connected; (3) the name and title of the elected city official or department head to whom such person has a familial relationship, and (4) the precise nature of such familial relationship.

**CITY OF CHICAGO
ECONOMIC DISCLOSURE STATEMENT AND AFFIDAVIT
APPENDIX B**

BUILDING CODE SCOFFLAW/PROBLEM LANDLORD CERTIFICATION

This Appendix is to be completed only by (a) the Applicant, and (b) any legal entity which has a direct ownership interest in the Applicant exceeding 7.5% (an "Owner"). It is not to be completed by any legal entity which has only an indirect ownership interest in the Applicant.

1. Pursuant to MCC Section 2-154-010, is the Applicant or any Owner identified as a building code scofflaw or problem landlord pursuant to MCC Section 2-92-416?

Yes No

2. If the Applicant is a legal entity publicly traded on any exchange, is any officer or director of the Applicant identified as a building code scofflaw or problem landlord pursuant to MCC Section 2-92-416?

Yes No The Applicant is not publicly traded on any exchange.

3. If yes to (1) or (2) above, please identify below the name of each person or legal entity identified as a building code scofflaw or problem landlord and the address of each building or buildings to which the pertinent code violations apply.

**CITY OF CHICAGO
ECONOMIC DISCLOSURE STATEMENT AND AFFIDAVIT
APPENDIX C**

PROHIBITION ON WAGE & SALARY HISTORY SCREENING - CERTIFICATION

This Appendix is to be completed only by an Applicant that is completing this EDS as a “contractor” as defined in MCC Section 2-92-385. That section, which should be consulted (www.amlegal.com), generally covers a party to any agreement pursuant to which they: (i) receive City of Chicago funds in consideration for services, work or goods provided (including for legal or other professional services), or (ii) pay the City money for a license, grant or concession allowing them to conduct a business on City premises.

On behalf of an Applicant that is a contractor pursuant to MCC Section 2-92-385, I hereby certify that the Applicant is in compliance with MCC Section 2-92-385(b)(1) and (2), which prohibit: (i) screening job applicants based on their wage or salary history, or (ii) seeking job applicants’ wage or salary history from current or former employers. I also certify that the Applicant has adopted a policy that includes those prohibitions.

Yes

No

N/A – I am not an Applicant that is a “contractor” as defined in MCC Section 2-92-385.

This certification shall serve as the affidavit required by MCC Section 2-92-385(c)(1).

If you checked “no” to the above, please explain.

**CITY OF CHICAGO
ECONOMIC DISCLOSURE STATEMENT
AND AFFIDAVIT**

SECTION I -- GENERAL INFORMATION

A. Legal name of the Disclosing Party submitting this EDS. Include d/b/a/ if applicable:

Carpenter Carroll LLC

Check ONE of the following three boxes:

Indicate whether the Disclosing Party submitting this EDS is:

1. the ~~Applicant~~ Property Owner
OR

2. a legal entity currently holding, or anticipated to hold within six months after City action on the contract, transaction or other undertaking to which this EDS pertains (referred to below as the "Matter"), a direct or indirect interest in excess of 7.5% in the ~~Applicant~~. State the ~~Applicant's~~ legal name: _____
Property Owner Property Owner's

OR

Property Owner

3. a legal entity with a direct or indirect right of control of the ~~Applicant~~ (see Section II(B)(1))
State the legal name of the entity in which the Disclosing Party holds a right of control:

B. Business address of the Disclosing Party: 1000 W. Carroll Avenue
Chicago, IL 60607

C. Telephone: 312-466-4100 Fax: 312-874-7008 Email: asimpson@sterlingbay.com

D. Name of contact person: Anna Simpson

E. Federal Employer Identification No. (if you have one): _____

F. Brief description of the Matter to which this EDS pertains. (Include project number and location of property, if applicable):

Application for planned development for property located at 345 N. Morgan St., 311 N. Morgan St., and 1000 W. Carroll, Chicago, IL

G. Which City agency or department is requesting this EDS? DPD

If the Matter is a contract being handled by the City's Department of Procurement Services, please complete the following:

Specification # N/A and Contract # N/A

SECTION II -- DISCLOSURE OF OWNERSHIP INTERESTS

A. NATURE OF THE DISCLOSING PARTY

1. Indicate the nature of the Disclosing Party:

- Person
 - Publicly registered business corporation
 - Privately held business corporation
 - Sole proprietorship
 - General partnership
 - Limited partnership
 - Trust
 - Limited liability company
 - Limited liability partnership
 - Joint venture
 - Not-for-profit corporation
- (Is the not-for-profit corporation also a 501(c)(3))?
 Yes No
 Other (please specify)
-

2. For legal entities, the state (or foreign country) of incorporation or organization, if applicable:

Illinois

3. For legal entities not organized in the State of Illinois: Has the organization registered to do business in the State of Illinois as a foreign entity?

- Yes
- No
- Organized in Illinois

B. IF THE DISCLOSING PARTY IS A LEGAL ENTITY:

1. List below the full names and titles, if applicable, of: (i) all executive officers and all directors of the entity; (ii) **for not-for-profit corporations**, all members, if any, which are legal entities (if there are no such members, write "no members which are legal entities"); (iii) **for trusts, estates or other similar entities**, the trustee, executor, administrator, or similarly situated party; (iv) **for general or limited partnerships, limited liability companies, limited liability partnerships or joint ventures**, each general partner, managing member, manager or any other person or legal entity that directly or indirectly controls the day-to-day management of the ~~Applicant~~ ^{Property Owner}.

NOTE: Each legal entity listed below must submit an EDS on its own behalf.

Name	Title
Susan Milligan- Manager	
William Milligan- Manager	

2. Please provide the following information concerning each person or legal entity having a direct or indirect, current or prospective (i.e. within 6 months after City action) beneficial interest (including ownership) in excess of 7.5% of the ~~Applicant~~ ^{Property Owner}. Examples of such an interest include shares in a corporation, partnership interest in a partnership or joint venture, interest of a member or manager in a

limited liability company, or interest of a beneficiary of a trust, estate or other similar entity. If none, state "None."

NOTE: Each legal entity listed below may be required to submit an EDS on its own behalf.

Name	Business Address	Percentage Interest in the	Property Owner
Susan Milligan-	1000 W. Carroll, Chicago, IL	60607- 50%	Applicant
William Milligan-	1000 W. Carroll, Chicago, IL	60607- 50%	

SECTION III -- INCOME OR COMPENSATION TO, OR OWNERSHIP BY, CITY ELECTED OFFICIALS

Has the Disclosing Party provided any income or compensation to any City elected official during the 12-month period preceding the date of this EDS? [] Yes [X] No

Does the Disclosing Party reasonably expect to provide any income or compensation to any City elected official during the 12-month period following the date of this EDS? [] Yes [X] No

If "yes" to either of the above, please identify below the name(s) of such City elected official(s) and describe such income or compensation:

Does any City elected official or, to the best of the Disclosing Party's knowledge after reasonable inquiry, any City elected official's spouse or domestic partner, have a financial interest (as defined in Chapter 2-156 of the Municipal Code of Chicago ("MCC")) in the Disclosing Party?

[] Yes [X] No

If "yes," please identify below the name(s) of such City elected official(s) and/or spouse(s)/domestic partner(s) and describe the financial interest(s).

SECTION IV -- DISCLOSURE OF SUBCONTRACTORS AND OTHER RETAINED PARTIES

The Disclosing Party must disclose the name and business address of each subcontractor, attorney, lobbyist (as defined in MCC Chapter 2-156), accountant, consultant and any other person or entity whom the Disclosing Party has retained or expects to retain in connection with the Matter, as well as the nature of the relationship, and the total amount of the fees paid or estimated to be paid. The Disclosing Party is not required to disclose employees who are paid solely through the Disclosing Party's regular payroll. If the Disclosing Party is uncertain whether a disclosure is required under this Section, the Disclosing Party must either ask the City whether disclosure is required or make the disclosure.

Name (indicate whether retained or anticipated to be retained)	Business Address	Relationship to Disclosing Party (subcontractor, attorney, lobbyist, etc.)	Fees (indicate whether paid or estimated.) NOTE: "hourly rate" or "t.b.d." is not an acceptable response.
--	------------------	--	---

(Add sheets if necessary)

Check here if the Disclosing Party has not retained, nor expects to retain, any such persons or entities.

SECTION V -- CERTIFICATIONS

A. COURT-ORDERED CHILD SUPPORT COMPLIANCE

Under MCC Section 2-92-415, substantial owners of business entities that contract with the City must remain in compliance with their child support obligations throughout the contract's term.

Has any person who directly or indirectly owns 10% or more of the Disclosing Party been declared in arrearage on any child support obligations by any Illinois court of competent jurisdiction?

Yes No No person directly or indirectly owns 10% or more of the Disclosing Party.

If "Yes," has the person entered into a court-approved agreement for payment of all support owed and is the person in compliance with that agreement?

Yes No

B. FURTHER CERTIFICATIONS

1. [This paragraph 1 applies only if the Matter is a contract being handled by the City's Department of Procurement Services.] In the 5-year period preceding the date of this EDS, neither the Disclosing Party nor any Affiliated Entity [see definition in (5) below] has engaged, in connection with the performance of any public contract, the services of an integrity monitor, independent private sector inspector general, or integrity compliance consultant (i.e., an individual or entity with legal, auditing, investigative, or other similar skills, designated by a public agency to help the agency monitor the activity of specified agency vendors as well as help the vendors reform their business practices so they can be considered for agency contracts in the future, or continue with a contract in progress).

2. The Disclosing Party and its Affiliated Entities are not delinquent in the payment of any fine, fee, tax or other source of indebtedness owed to the City of Chicago, including, but not limited to, water and sewer charges, license fees, parking tickets, property taxes and sales taxes, nor is the Disclosing Party delinquent in the payment of any tax administered by the Illinois Department of Revenue.

3. The Disclosing Party and, if the Disclosing Party is a legal entity, all of those persons or entities identified in Section II(B)(1) of this EDS:

a. are not presently debarred, suspended, proposed for debarment, declared ineligible or voluntarily excluded from any transactions by any federal, state or local unit of government;

b. have not, during the 5 years before the date of this EDS, been convicted of a criminal offense, adjudged guilty, or had a civil judgment rendered against them in connection with: obtaining, attempting to obtain, or performing a public (federal, state or local) transaction or contract under a public transaction; a violation of federal or state antitrust statutes; fraud; embezzlement; theft; forgery; bribery; falsification or destruction of records; making false statements; or receiving stolen property;

c. are not presently indicted for, or criminally or civilly charged by, a governmental entity (federal, state or local) with committing any of the offenses set forth in subparagraph (b) above;

d. have not, during the 5 years before the date of this EDS, had one or more public transactions (federal, state or local) terminated for cause or default; and

e. have not, during the 5 years before the date of this EDS, been convicted, adjudged guilty, or found liable in a civil proceeding, or in any criminal or civil action, including actions concerning environmental violations, instituted by the City or by the federal government, any state, or any other unit of local government.

4. The Disclosing Party understands and shall comply with the applicable requirements of MCC Chapters 2-56 (Inspector General) and 2-156 (Governmental Ethics).

5. Certifications (5), (6) and (7) concern:

- the Disclosing Party;
- any "Contractor" (meaning any contractor or subcontractor used by the Disclosing Party in connection with the Matter, including but not limited to all persons or legal entities disclosed under Section IV, "Disclosure of Subcontractors and Other Retained Parties");
- any "Affiliated Entity" (meaning a person or entity that, directly or indirectly: controls the Disclosing Party, is controlled by the Disclosing Party, or is, with the Disclosing Party, under common control of another person or entity). Indicia of control include, without limitation: interlocking management or ownership; identity of interests among family members, shared facilities and equipment; common use of employees; or organization of a business entity following the ineligibility of a business entity to do business with federal or state or local government, including the City, using substantially the same management, ownership, or principals as the ineligible entity. With respect to Contractors, the term Affiliated Entity means a person or entity that directly or indirectly controls the Contractor, is controlled by it, or, with the Contractor, is under common control of another person or entity;
- any responsible official of the Disclosing Party, any Contractor or any Affiliated Entity or any other official, agent or employee of the Disclosing Party, any Contractor or any Affiliated Entity, acting pursuant to the direction or authorization of a responsible official of the Disclosing Party, any Contractor or any Affiliated Entity (collectively "Agents").

Neither the Disclosing Party, nor any Contractor, nor any Affiliated Entity of either the Disclosing Party or any Contractor, nor any Agents have, during the 5 years before the date of this EDS, or, with respect to a Contractor, an Affiliated Entity, or an Affiliated Entity of a Contractor during the 5 years before the date of such Contractor's or Affiliated Entity's contract or engagement in connection with the Matter:

- a. bribed or attempted to bribe, or been convicted or adjudged guilty of bribery or attempting to bribe, a public officer or employee of the City, the State of Illinois, or any agency of the federal government or of any state or local government in the United States of America, in that officer's or employee's official capacity;
- b. agreed or colluded with other bidders or prospective bidders, or been a party to any such agreement, or been convicted or adjudged guilty of agreement or collusion among bidders or prospective bidders, in restraint of freedom of competition by agreement to bid a fixed price or otherwise; or
- c. made an admission of such conduct described in subparagraph (a) or (b) above that is a matter of record, but have not been prosecuted for such conduct; or
- d. violated the provisions referenced in MCC Subsection 2-92-320(a)(4)(Contracts Requiring a Base Wage); (a)(5)(Debarment Regulations); or (a)(6)(Minimum Wage Ordinance).

6. Neither the Disclosing Party, nor any Affiliated Entity or Contractor, or any of their employees, officials, agents or partners, is barred from contracting with any unit of state or local government as a result of engaging in or being convicted of (1) bid-rigging in violation of 720 ILCS 5/33E-3; (2) bid-rotating in violation of 720 ILCS 5/33E-4; or (3) any similar offense of any state or of the United States of America that contains the same elements as the offense of bid-rigging or bid-rotating.

7. Neither the Disclosing Party nor any Affiliated Entity is listed on a Sanctions List maintained by the United States Department of Commerce, State, or Treasury, or any successor federal agency.

8. [FOR ~~APPLICANT~~ ^{PROPERTY OWNER} ONLY] (i) Neither the ~~Applicant~~ ^{Property Owner} nor any "controlling person" [see MCC Chapter 1-23, Article I for applicability and defined terms] of the ~~Applicant~~ ^{Property Owner} is currently indicted or charged with, or has admitted guilt of, or has ever been convicted of, or placed under supervision for, any criminal offense involving actual, attempted, or conspiracy to commit bribery, theft, fraud, forgery, perjury, dishonesty or deceit against an officer or employee of the City or any "sister agency"; and (ii) the ~~Applicant~~ ^{Property Owner} understands and acknowledges that compliance with Article I is a continuing requirement for doing business with the City. NOTE: If MCC Chapter 1-23, Article I applies to the ~~Applicant~~ ^{Property Owner}, that Article's permanent compliance timeframe supersedes 5-year compliance timeframes in this Section V.

9. [FOR ~~APPLICANT~~ ^{PROPERTY OWNER} ONLY] The ~~Applicant~~ ^{Property Owner} and its Affiliated Entities will not use, nor permit their subcontractors to use, any facility listed as having an active exclusion by the U.S. EPA on the federal System for Award Management ("SAM").

10. [FOR ~~APPLICANT~~ ^{PROPERTY OWNER} ONLY] The ~~Applicant~~ ^{Property Owner} will obtain from any contractors/subcontractors hired or to be hired in connection with the Matter certifications equal in form and substance to those in Certifications (2) and (9) above and will not, without the prior written consent of the City, use any such

contractor/subcontractor that does not provide such certifications or that the ~~Applicant~~ ^{Property Owner} has reason to believe has not provided or cannot provide truthful certifications.

11. If the Disclosing Party is unable to certify to any of the above statements in this Part B (Further Certifications), the Disclosing Party must explain below:

N/A

If the letters "NA," the word "None," or no response appears on the lines above, it will be conclusively presumed that the Disclosing Party certified to the above statements.

12. To the best of the Disclosing Party's knowledge after reasonable inquiry, the following is a complete list of all current employees of the Disclosing Party who were, at any time during the 12-month period preceding the date of this EDS, an employee, or elected or appointed official, of the City of Chicago (if none, indicate with "N/A" or "none").

N/A

13. To the best of the Disclosing Party's knowledge after reasonable inquiry, the following is a complete list of all gifts that the Disclosing Party has given or caused to be given, at any time during the 12-month period preceding the execution date of this EDS, to an employee, or elected or appointed official, of the City of Chicago. For purposes of this statement, a "gift" does not include: (i) anything made generally available to City employees or to the general public, or (ii) food or drink provided in the course of official City business and having a retail value of less than \$25 per recipient, or (iii) a political contribution otherwise duly reported as required by law (if none, indicate with "N/A" or "none"). As to any gift listed below, please also list the name of the City recipient.

N/A

C. CERTIFICATION OF STATUS AS FINANCIAL INSTITUTION

1. The Disclosing Party certifies that the Disclosing Party (check one)

is is not

a "financial institution" as defined in MCC Section 2-32-455(b).

2. If the Disclosing Party IS a financial institution, then the Disclosing Party pledges:

"We are not and will not become a predatory lender as defined in MCC Chapter 2-32. We further pledge that none of our affiliates is, and none of them will become, a predatory lender as defined in MCC Chapter 2-32. We understand that becoming a predatory lender or becoming an affiliate of a predatory lender may result in the loss of the privilege of doing business with the City."

If the Disclosing Party is unable to make this pledge because it or any of its affiliates (as defined in MCC Section 2-32-455(b)) is a predatory lender within the meaning of MCC Chapter 2-32, explain here (attach additional pages if necessary):

If the letters "NA," the word "None," or no response appears on the lines above, it will be conclusively presumed that the Disclosing Party certified to the above statements.

D. CERTIFICATION REGARDING FINANCIAL INTEREST IN CITY BUSINESS

Any words or terms defined in MCC Chapter 2-156 have the same meanings if used in this Part D.

1. In accordance with MCC Section 2-156-110: To the best of the Disclosing Party's knowledge after reasonable inquiry, does any official or employee of the City have a financial interest in his or her own name or in the name of any other person or entity in the Matter?

Yes No

NOTE: If you checked "Yes" to Item D(1), proceed to Items D(2) and D(3). If you checked "No" to Item D(1), skip Items D(2) and D(3) and proceed to Part E.

2. Unless sold pursuant to a process of competitive bidding, or otherwise permitted, no City elected official or employee shall have a financial interest in his or her own name or in the name of any other person or entity in the purchase of any property that (i) belongs to the City, or (ii) is sold for taxes or assessments, or (iii) is sold by virtue of legal process at the suit of the City (collectively, "City Property Sale"). Compensation for property taken pursuant to the City's eminent domain power does not constitute a financial interest within the meaning of this Part D.

Does the Matter involve a City Property Sale?

Yes No

3. If you checked "Yes" to Item D(1), provide the names and business addresses of the City officials or employees having such financial interest and identify the nature of the financial interest:

Name	Business Address	Nature of Financial Interest
_____	_____	_____
_____	_____	_____
_____	_____	_____

4. The Disclosing Party further certifies that no prohibited financial interest in the Matter will be acquired by any City official or employee.

E. CERTIFICATION REGARDING SLAVERY ERA BUSINESS

Please check either (1) or (2) below. If the Disclosing Party checks (2), the Disclosing Party must disclose below or in an attachment to this EDS all information required by (2). Failure to comply with these disclosure requirements may make any contract entered into with the City in connection with the Matter voidable by the City.

X 1. The Disclosing Party verifies that the Disclosing Party has searched any and all records of the Disclosing Party and any and all predecessor entities regarding records of investments or profits from slavery or slaveholder insurance policies during the slavery era (including insurance policies issued to slaveholders that provided coverage for damage to or injury or death of their slaves), and the Disclosing Party has found no such records.

___ 2. The Disclosing Party verifies that, as a result of conducting the search in step (1) above, the Disclosing Party has found records of investments or profits from slavery or slaveholder insurance policies. The Disclosing Party verifies that the following constitutes full disclosure of all such records, including the names of any and all slaves or slaveholders described in those records:

SECTION VI -- CERTIFICATIONS FOR FEDERALLY FUNDED MATTERS

NOTE: If the Matter is federally funded, complete this Section VI. If the Matter is not federally funded, proceed to Section VII. For purposes of this Section VI, tax credits allocated by the City and proceeds of debt obligations of the City are not federal funding.

A. CERTIFICATION REGARDING LOBBYING

1. List below the names of all persons or entities registered under the federal Lobbying Disclosure Act of 1995, as amended, who have made lobbying contacts on behalf of the Disclosing Party with respect to the Matter: (Add sheets if necessary):

(If no explanation appears or begins on the lines above, or if the letters "NA" or if the word "None" appear, it will be conclusively presumed that the Disclosing Party means that NO persons or entities registered under the Lobbying Disclosure Act of 1995, as amended, have made lobbying contacts on behalf of the Disclosing Party with respect to the Matter.)

2. The Disclosing Party has not spent and will not expend any federally appropriated funds to pay any person or entity listed in paragraph A(1) above for his or her lobbying activities or to pay any person or entity to influence or attempt to influence an officer or employee of any agency, as defined by applicable federal law, a member of Congress, an officer or employee of Congress, or an employee

of a member of Congress, in connection with the award of any federally funded contract, making any federally funded grant or loan, entering into any cooperative agreement, or to extend, continue, renew, amend, or modify any federally funded contract, grant, loan, or cooperative agreement.

3. The Disclosing Party will submit an updated certification at the end of each calendar quarter in which there occurs any event that materially affects the accuracy of the statements and information set forth in paragraphs A(1) and A(2) above.

4. The Disclosing Party certifies that either: (i) it is not an organization described in section 501(c)(4) of the Internal Revenue Code of 1986; or (ii) it is an organization described in section 501(c)(4) of the Internal Revenue Code of 1986 but has not engaged and will not engage in "Lobbying Activities," as that term is defined in the Lobbying Disclosure Act of 1995, as amended.

5. If the Disclosing Party is the ~~Applicant~~ ^{Property Owner}, the Disclosing Party must obtain certifications equal in form and substance to paragraphs A(1) through A(4) above from all subcontractors before it awards any subcontract and the Disclosing Party must maintain all such subcontractors' certifications for the duration of the Matter and must make such certifications promptly available to the City upon request.

B. CERTIFICATION REGARDING EQUAL EMPLOYMENT OPPORTUNITY

If the Matter is federally funded, federal regulations require the ~~Applicant~~ ^{Property Owner} and all proposed subcontractors to submit the following information with their bids or in writing at the outset of negotiations.

Is the Disclosing Party the ~~Applicant~~ ^{Property Owner}?
 Yes No

If "Yes," answer the three questions below:

1. Have you developed and do you have on file affirmative action programs pursuant to applicable federal regulations? (See 41 CFR Part 60-2.)
 Yes No

2. Have you filed with the Joint Reporting Committee, the Director of the Office of Federal Contract Compliance Programs, or the Equal Employment Opportunity Commission all reports due under the applicable filing requirements?
 Yes No Reports not required

3. Have you participated in any previous contracts or subcontracts subject to the equal opportunity clause?
 Yes No

If you checked "No" to question (1) or (2) above, please provide an explanation:

SECTION VII -- FURTHER ACKNOWLEDGMENTS AND CERTIFICATION

The Disclosing Party understands and agrees that:

A. The certifications, disclosures, and acknowledgments contained in this EDS will become part of any contract or other agreement between the ~~Applicant~~ ^{Property Owner} and the City in connection with the Matter, whether procurement, City assistance, or other City action, and are material inducements to the City's execution of any contract or taking other action with respect to the Matter. The Disclosing Party understands that it must comply with all statutes, ordinances, and regulations on which this EDS is based.

B. The City's Governmental Ethics Ordinance, MCC Chapter 2-156, imposes certain duties and obligations on persons or entities seeking City contracts, work, business, or transactions. The full text of this ordinance and a training program is available on line at www.cityofchicago.org/Ethics, and may also be obtained from the City's Board of Ethics, 740 N. Sedgwick St., Suite 500, Chicago, IL 60610, (312) 744-9660. The Disclosing Party must comply fully with this ordinance.

C. If the City determines that any information provided in this EDS is false, incomplete or inaccurate, any contract or other agreement in connection with which it is submitted may be rescinded or be void or voidable, and the City may pursue any remedies under the contract or agreement (if not rescinded or void), at law, or in equity, including terminating the Disclosing Party's participation in the Matter and/or declining to allow the Disclosing Party to participate in other City transactions. Remedies at law for a false statement of material fact may include incarceration and an award to the City of treble damages.

D. It is the City's policy to make this document available to the public on its Internet site and/or upon request. Some or all of the information provided in, and appended to, this EDS may be made publicly available on the Internet, in response to a Freedom of Information Act request, or otherwise. By completing and signing this EDS, the Disclosing Party waives and releases any possible rights or claims which it may have against the City in connection with the public release of information contained in this EDS and also authorizes the City to verify the accuracy of any information submitted in this EDS.

E. The information provided in this EDS must be kept current. In the event of changes, the Disclosing Party must supplement this EDS up to the time the City takes action on the Matter. If the Matter is a contract being handled by the City's Department of Procurement Services, the Disclosing Party must update this EDS as the contract requires. **NOTE:** With respect to Matters subject to MCC Chapter 1-23, Article I (imposing **PERMANENT INELIGIBILITY** for certain specified offenses), the information provided herein regarding eligibility must be kept current for a longer period, as required by MCC Chapter 1-23 and Section 2-154-020.

CERTIFICATION

Under penalty of perjury, the person signing below: (1) warrants that he/she is authorized to execute this EDS, and all applicable Appendices, on behalf of the Disclosing Party, and (2) warrants that all certifications and statements contained in this EDS, and all applicable Appendices, are true, accurate and complete as of the date furnished to the City.

CARPENTER CARROLL LLC

(Print or type exact legal name of Disclosing Party)

By: Susan Milligan
(Sign here)

Susan Milligan

(Print or type name of person signing)

MANAGER

(Print or type title of person signing)

Signed and sworn to before me on (date) February 20, 2019.

at Cook County, IL (state).

Agatha Omelan
Notary Public

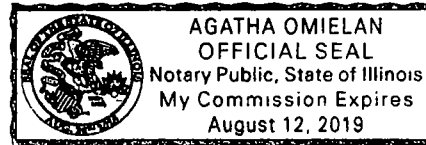

Commission expires: August 12, 2019

1. The first part of the document is a list of names and their corresponding page numbers. The names are listed in a single column, and the page numbers are listed in a second column to the right of the names. The names are: John Doe, Jane Smith, and Bob Johnson. The page numbers are: 10, 20, and 30.

**CITY OF CHICAGO
ECONOMIC DISCLOSURE STATEMENT AND AFFIDAVIT
APPENDIX A**

**FAMILIAL RELATIONSHIPS WITH ELECTED CITY OFFICIALS
AND DEPARTMENT HEADS**

Property Owner

This Appendix is to be completed only by (a) the Applicant, and (b) any legal entity which has a direct ownership interest in the Applicant exceeding 7.5%. It is not to be completed by any legal entity which has only an indirect ownership interest in the Applicant.

Property Owner

Under MCC Section 2-154-015, the Disclosing Party must disclose whether such Disclosing Party or any "Applicable Party" or any Spouse or Domestic Partner thereof currently has a "familial relationship" with any elected city official or department head. A "familial relationship" exists if, as of the date this EDS is signed, the Disclosing Party or any "Applicable Party" or any Spouse or Domestic Partner thereof is related to the mayor, any alderman, the city clerk, the city treasurer or any city department head as spouse or domestic partner or as any of the following, whether by blood or adoption: parent, child, brother or sister, aunt or uncle, niece or nephew, grandparent, grandchild, father-in-law, mother-in-law, son-in-law, daughter-in-law, stepfather or stepmother, stepson or stepdaughter, stepbrother or stepsister or half-brother or half-sister.

"Applicable Party" means (1) all executive officers of the Disclosing Party listed in Section II.B.1.a., if the Disclosing Party is a corporation; all partners of the Disclosing Party, if the Disclosing Party is a general partnership; all general partners and limited partners of the Disclosing Party, if the Disclosing Party is a limited partnership; all managers, managing members and members of the Disclosing Party, if the Disclosing Party is a limited liability company; (2) all principal officers of the Disclosing Party; and (3) any person having more than a 7.5% ownership interest in the Disclosing Party. "Principal officers" means the president, chief operating officer, executive director, chief financial officer, treasurer or secretary of a legal entity or any person exercising similar authority.

Does the Disclosing Party or any "Applicable Party" or any Spouse or Domestic Partner thereof currently have a "familial relationship" with an elected city official or department head?

[] Yes [X] No

If yes, please identify below (1) the name and title of such person, (2) the name of the legal entity to which such person is connected; (3) the name and title of the elected city official or department head to whom such person has a familial relationship, and (4) the precise nature of such familial relationship.

**CITY OF CHICAGO
ECONOMIC DISCLOSURE STATEMENT AND AFFIDAVIT
APPENDIX B**

BUILDING CODE SCOFFLAW/PROBLEM LANDLORD CERTIFICATION

This Appendix is to be completed only by (a) the ^{Property Owner} ~~Applicant~~, and (b) any legal entity which has a direct ownership interest in the ~~Applicant~~ ^{Property Owner} exceeding 7.5% (an "Owner"). It is not to be completed by any legal entity which has only an indirect ownership interest in the ~~Applicant~~ ^{Property Owner}.

1. Pursuant to MCC Section 2-154-010, is the ^{Property Owner} ~~Applicant~~ or any Owner identified as a building code scofflaw or problem landlord pursuant to MCC Section 2-92-416?

Yes No

2. If the ^{Property Owner} ~~Applicant~~ is a legal entity publicly traded on any exchange, is any officer or director of the ~~Applicant~~ ^{Property Owner} identified as a building code scofflaw or problem landlord pursuant to MCC Section 2-92-416?

Yes No The ^{Property Owner} ~~Applicant~~ is not publicly traded on any exchange.

3. If yes to (1) or (2) above, please identify below the name of each person or legal entity identified as a building code scofflaw or problem landlord and the address of each building or buildings to which the pertinent code violations apply.

**CITY OF CHICAGO
ECONOMIC DISCLOSURE STATEMENT AND AFFIDAVIT
APPENDIX C**

PROHIBITION ON WAGE & SALARY HISTORY SCREENING - CERTIFICATION

This Appendix is to be completed only by an ~~Applicant~~ ^{Property Owner} that is completing this EDS as a “contractor” as defined in MCC Section 2-92-385. That section, which should be consulted (www.amlegal.com), generally covers a party to any agreement pursuant to which they: (i) receive City of Chicago funds in consideration for services, work or goods provided (including for legal or other professional services), or (ii) pay the City money for a license, grant or concession allowing them to conduct a business on City premises.

On behalf of an ~~Applicant~~ ^{Property Owner} that is a contractor pursuant to MCC Section 2-92-385, I hereby certify that the ~~Applicant~~ ^{Property Owner} is in compliance with MCC Section 2-92-385(b)(1) and (2), which prohibit: (i) screening job applicants based on their wage or salary history, or (ii) seeking job applicants’ wage or salary history from current or former employers. I also certify that the ~~Applicant~~ ^{Property Owner} has adopted a policy that includes those prohibitions.

Yes

No

N/A – I am not an ~~Applicant~~ ^{Property Owner} that is a “contractor” as defined in MCC Section 2-92-385.

This certification shall serve as the affidavit required by MCC Section 2-92-385(c)(1).

If you checked “no” to the above, please explain.
